

DORMER  PRAMET

**RAILWAY
INDUSTRY SPECIFIC
HIGHLIGHTS**





7		INTRODUCTION & ASSORTMENT HIGHLIGHTS
13	RAILWAY INDUSTRY	PRODUCTION OF NEW RAILWAY WHEELS
20		RAILWAY WHEEL RECONDITIONING
26		AXLES MACHINING
30		STATIONARY & DYNAMIC RAIL MILLING
37		TURNOUTS MACHINING
57		BASE PLATES MACHINING
63		WAGON & BOGIE PARTS MACHINING
73		TURNING ASSORTMENT
88	POSITIVE INSERTS	
107	NEGATIVE INSERTS	
146		INDEXABLE MILLS
166		TECHNICAL PART



PRODUCT FAMILY		PRODUCT FAMILY		PRODUCT FAMILY		PRODUCT FAMILY	
C		DKT(RL)-D		P		SRDCN EXT	
C.-SRDCN EXT	102		115, 127	PRDCN EXT	98		100
			138	PRSC(RL) EXT	99	SRSC(RL) EXT	101
D		K		S			
DKH(RL)	104	KHP-RSC(RL)	103	S-DKT(RL)4065X	128, 139		
DKT(RL)-A	112, 124, 135	KTP-CAN(RL)	119	S-DKT(RL)4065X+KTP	117		
DKT(RL)-B	113, 125, 136	KTP-CFN(RL)	120	S-DKT(RL)4065X-C	116		
DKT(RL)-C	114, 126, 137	KTP-LAN(RL)	131	S-DKT(RL)4065X-S	129, 140		
		KTP-LFN(RL)	132	S-DKT(RL)5556	118, 130, 141		
		KTP-SAN(RL)	142				
		KTP-SFN(RL)	143				



PRODUCT FAMILY		PRODUCT FAMILY		PRODUCT FAMILY		PRODUCT FAMILY	
(S-)CN.. 08 – 15	152	(S-)SNE. 12; 15 (KCH)	151	O		SNXN 13	157
(S-)LC 16 – 32	163	(S-)SNEX 13 – 27	158	OPCN 06	90	S-RNEX 15	165
(S-)LC 32	164	(S-)SP.W 14 – 19	161	R		S-RNEX 16	165
(S-)LDEX 12; 13 (CEMR)	155	(S-)SP.X 12 – 27	159	RCMH	92	S-RPGN 20	163
(S-)LNE. 13; 15 (RE)	152	(S-)XOEX 12	154	RCMT	93	S-SPEN 12	162
(S-)LPGX 27	161	S		RCMX	95	S-SPEN 12; 15	162
(S-)SN.. 12; 15 (CEMR)	154	513000; LNEQ 28	151	RCUM	97	T	
(S-)SN.. 12; 15 (CHW)	150	B		RNGX 12	164	TNMN	145
(S-)SN.. 12; 15 (RE)	152	BNMX 20	109	ROEX 15	165	TU 14	145
(S-)SN.. 12; 16 (CEMR)	156	C		RPUX	106		
(S-)SN.. 15 (CEMR)	153	CNMX 19	111	S			
(S-)SN../(S-)LNEQ 12; 15 (RE)	153	L		S-CDEW 11/(S-)XDE. 12 – 16	155		
(S-)SN.Q 15	160	LN.X 19, LN.X 30	122	S-LNEX 15	160		
(S-)SNE. 12 – 15 (RE)	150	LNE 434	151	SNEX 13; 15 (CEMR)	157		
		LNMT	123	SNMX 19	134		



DORMER PRAMET

DELIVERING THE FAB FOUR

We have revamped our general metric product catalogues, featuring more than **20,000** cutting tools. The four publications cover the main application categories – holemaking, milling, turning and threading. Download your copy today!

Simply Reliable.

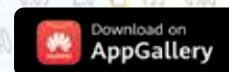
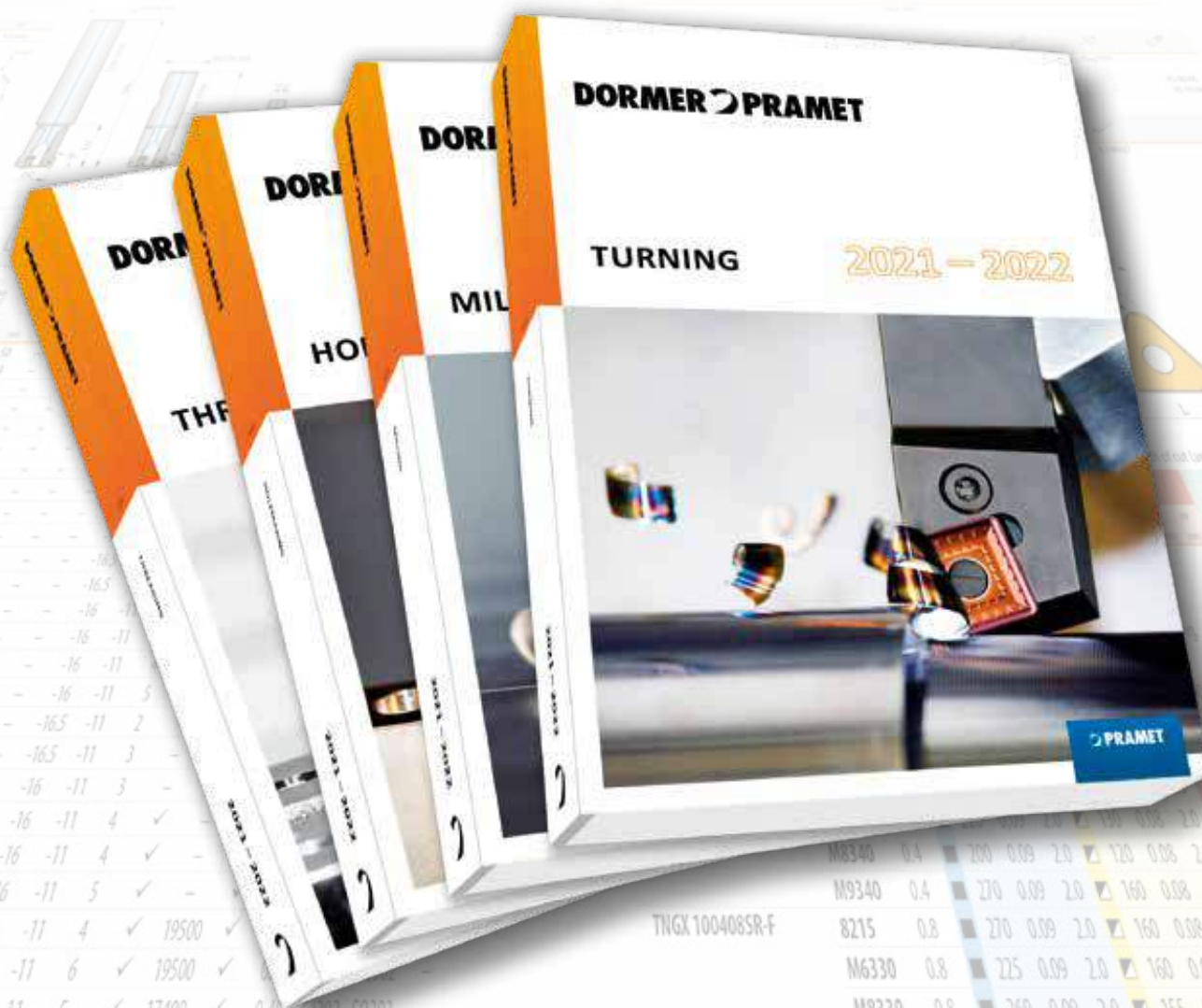



7		INTRODUCTION & ASSORTMENT HIGHLIGHTS
13	RAILWAY INDUSTRY	PRODUCTION OF NEW RAILWAY WHEELS
20		RAILWAY WHEEL RECONDITIONING
26		AXLES MACHINING
30		STATIONARY & DYNAMIC RAIL MILLING
37		TURNOUTS MACHINING
57		BASE PLATES MACHINING
63		WAGON & BOGIE PARTS MACHINING
73		TURNING ASSORTMENT
88	POSITIVE INSERTS	
107	NEGATIVE INSERTS	
146		INDEXABLE MILLS
166		TECHNICAL PART



DORMER PRAMET

FOLLOW US



SHARE



LIKE



COMMENT



TAG



RE-TWEET





INTRODUCTION

Dormer Pramet has more than 100 years of experience in the cutting tool industry. It has been several decades since we developed our first product for the railway segment. Since then, we have added many to our portfolio and we are constantly innovating to meet customer needs.

The railway industry requires a variety of different components that are machined in many ways. Having the right cutting tools is paramount. Dormer Pramet offer numerous standard and tailor-made turning tools for machining railway wheels and axles as well as milling and drilling tools for machining rails, turnouts, base plates and wagon parts.

This catalogue brings you the selection of tools, their usage recommendations and other tips that will help you increase your productivity, performance and reliability



With the many different workpiece materials and variety of sizes requiring several machining operations, this program of diverse cutting tools demonstrates Dormer Pramet's commitment to the railway segment, with further additions planned in the coming years.

For more information on Dormer Pramet's complete product range, please visit www.dormerpramet.com or contact your local sales office.



New wheels machining

Dormer Pramet is offering a comprehensive range of round inserts in sizes RCMX 16, 20, 25, 30 and 32 with chip-breakers suitable for roughing to finishing of forged train and locomotive wheels.

You can choose from high performance CVD grades for areas P10 up to P35 that are suitable for hard and soft wheels machining with usage of high feeds and speeds.

Besides the standard tools we can also offer specials in terms of inserts as well as of holders with specific back-ends.



Axles machining

Dormer Pramet offers standard assortment of roughing and finishing turning tools. Large, negative inserts with chip-breakers are suitable for high material removal where rigidity of inserts is vital. On the other hand, smaller positive inserts with sharp geometry are used for achieving a fine surface quality.

Among the standard assortment of solid drills, indexable drills, Hydra drills and taps, we can also offer special tailor-made variants.



Re-turning of wheels

Dormer Pramet offers a complete line of tools for wheel re-turning. Holders for Hegenscheidt, Rafamet and other machine tools are equipped with exchangeable cartridges with protective cemented carbide shims.

Our insert geometries and grades can satisfy all customer needs. Inserts LNMX 19, LNMX 30, SNMX 19 and CNMX 19 with chipbreakers RR, RM ensure high material removal, whereas RF, TF make a perfect surface.

Inserts LNMX 30, LNMT 31 and TNMN are suitable for very high material removal rate with maximum depth of cut up to 15 mm.

ROEX 15 and RNGX 12 inserts for renovation of wheels by milling make our offer complete.





Dynamic rail milling

The all-in-one space and money saving design of milling cutters for machining of rails, these cutters consist of universal basic body for left and right spindles and easily interchangeable cartridges that each contains 11 indexable inserts.

Cutters are available in \varnothing 290 mm, \varnothing 600 mm and \varnothing 900 mm.

Cutting profile is defined by the cartridges and indexable inserts and can be used for machining of rail profiles 60E1, 60E2, 54E5, 54E1, 46E3 and others upon request.

High reliability of the cutting process is ensured by usage of rigid tangential inserts with 8 and 4 cutting edges and by usage of PVD grade that has a durability up to 3.5 km per cutting edge.



Switches



We are able to satisfy the needs of machining any material the switches are made of. Our experience in switch assembly machining can be demonstrated by one simple figure: during our history we have produced and delivered more than 400 types of cutters for machining of the rail head, web, base and grooves of most common rail profiles like 60E1, 60E2, 54E1 and others.

Our cutters are developed with maximum productivity in mind as well as maximum operational reliability. Therefore, most of the cutters are designed with tangential inserts that are also very economical due to the high number of cutting edges.

We also offer a variety of very productive standard tools like “Penta HD” face milling cutter or high-performance replaceable head drill – “Hydra”.

Wagon parts

Dormer Pramet offers a wide range of standard and special tools for machining of a large variety of wagon parts like carriage body, side frames, bolsters, bearing houses, couplings and other parts. We can satisfy all customer's needs in case of face milling, square shoulder milling, HFC milling, indexable and solid round tools drilling and in many more applications.

The comprehensive tailor-made range of technology we offer for the machining of couplers is an example of our capabilities in the wagon production segment.

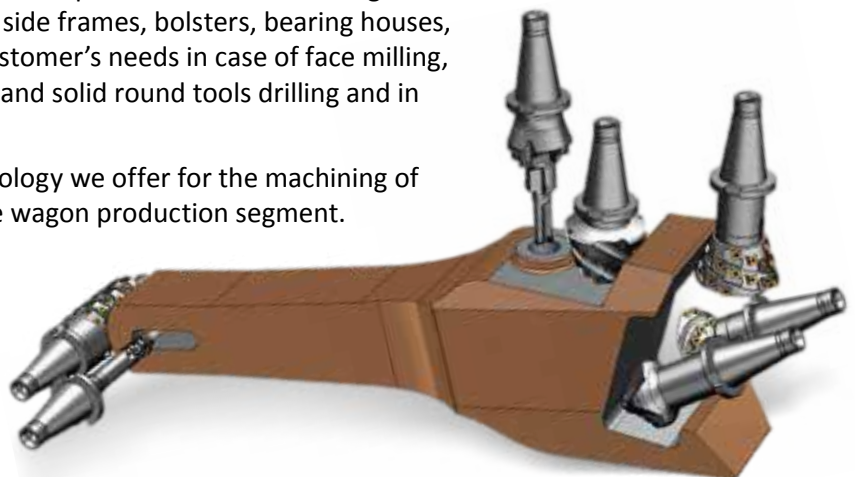



**RAILWAY
INDUSTRY**





7		INTRODUCTION & ASSORTMENT HIGHLIGHTS
13	RAILWAY INDUSTRY	PRODUCTION OF NEW RAILWAY WHEELS
20		RAILWAY WHEEL RECONDITIONING
26		AXLES MACHINING
30		STATIONARY & DYNAMIC RAIL MILLING
37		TURNOUTS MACHINING
57		BASE PLATES MACHINING
63		WAGON & BOGIE PARTS MACHINING
73		TURNING ASSORTMENT
88	POSITIVE INSERTS	
107	NEGATIVE INSERTS	
146	INDEXABLE MILLS	
166		TECHNICAL PART



DORMER PRAMET



POCKET SAVER

Our machining calculator allows you to measure the savings based on different products and applications. A useful pocket-sized tool, which will help keep cash in your pockets! **Simply Reliable.**

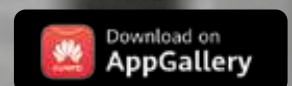
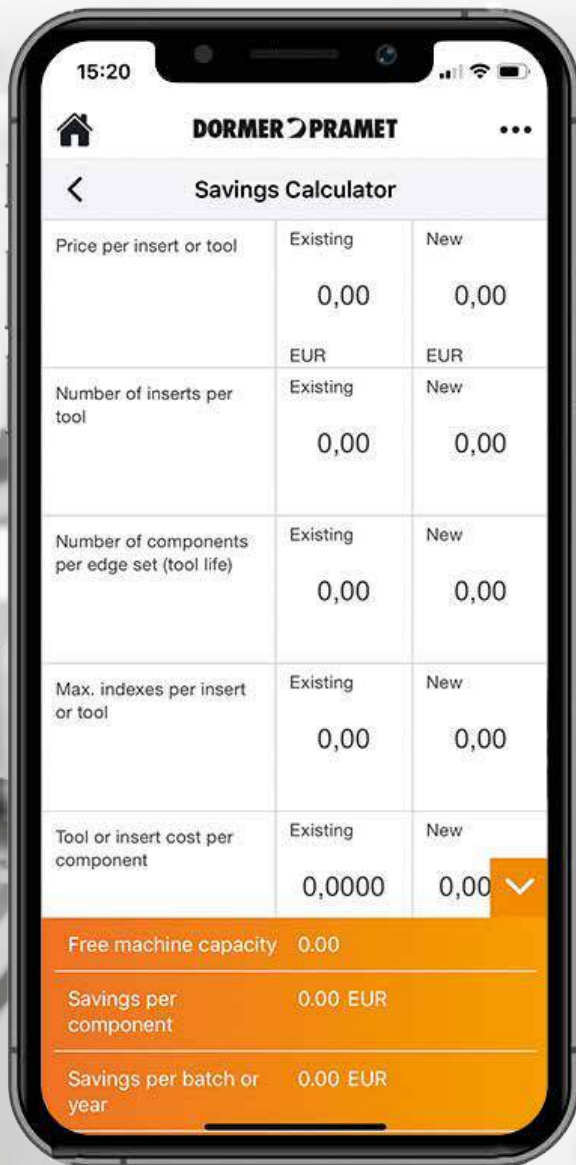



PRODUCTION OF NEW RAILWAY WHEELS



RAILWAY WHEELS

Railway wheels are the only pieces that contact the rails, and have the biggest impact on train efficiency. Therefore, a high demand on wheel surface quality is needed. Roughness and shape precision has a major significance for forces, wear behavior, friction and vibrations.

In the contact zone between railway wheel and rail the surfaces and bulk material must be strong enough to resist the normal (vertical) forces introduced by heavy loads and the dynamic response induced by track and wheel irregularities. The tangential forces in the contact zone must be low enough to allow moving heavy loads with little resistance, at the same time the tangential loads must be high enough to provide traction, braking, and steering of the trains.

Wear occurs in the contact if wheels are poorly lubricated due to sliding that is typical of wheel-rail contact. The friction between the wheels and rail is extremely important as it plays a major role in the wheel-rail interface process such as adhesion, wear, rolling contact fatigue, and noise generation. Effective control of friction through the application of friction modifiers to the wheel-rail contact is therefore clearly advantageous, although the process must be carefully managed. The aim of friction management is to maintain friction levels in the wheel-rail contact to give.

Railway operations also generate vibrations that are transmitted through the ground into neighboring properties. These can lead either to feel able vibration (in the range 4 to 80 Hz) or to low frequency rumbling noise (30 to 250 Hz). Vibrations are also transmitted into the vehicle itself, affecting passenger comfort. The most important mechanical noise source from a train is generated at the wheel-rail contact. Rolling noise is caused by vibrations of the wheel and track structures, induced at the wheel-rail contact point by vertical irregularities in the wheel and rail surfaces.





NEW WHEELS MACHINING

Dormer Pramet has longtime experience with machining of railway wheels. We aim to meet the most demanding requirements in terms of quality, reliability and productivity.

Nowadays, we cooperate with dozen of factories around the world with a total annual production more than 8 million wheels. We also deliver high quality level of technical service.

Machining of railway wheels is very specific technology, which is based on the principle of copying the shape by round cutting edge. One of the main issues is determining the optimal chip thickness with respect to force balance, heat distribution as well as to ideal chip breaking. Dormer Pramet gives you optimal and economic solution for your production.

Middle chip thickness

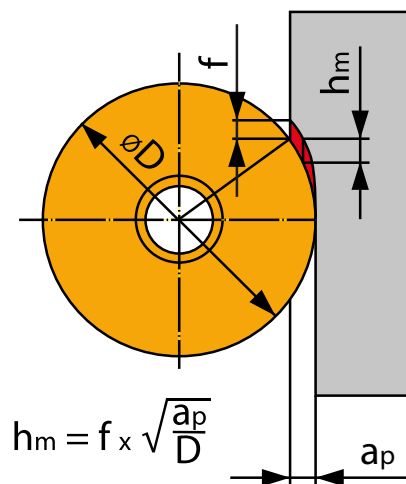

NOMENCLATURE

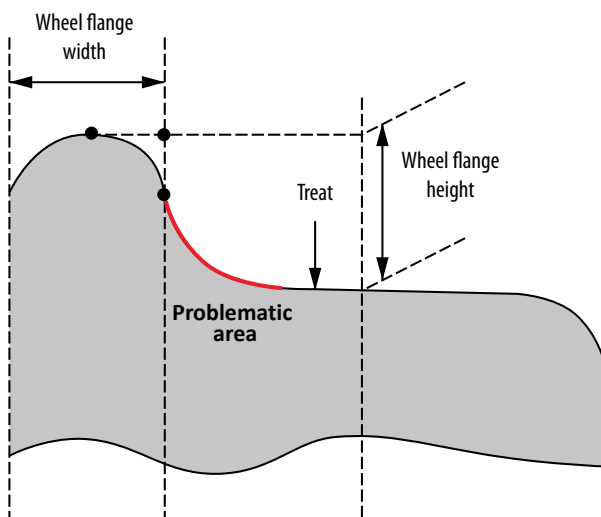

We can offer:

- Reliable cutting process
- Lifetime and productivity
- Optimal chip breaking
- Dimension accuracy and stability
- Surface quality
- Continuous development

Recommended middle chip thickness

Insert	Chipbreaker	hm
RCMX 32	000108	0.400
RCMT, RCMX 16	37	0.375
RCMX 25	37	0.425
RCMX 16	331	0.225
RCMX 20	341	0.250
RCMX 25	351	0.350
RCMX 32	361	0.450
RCMT 20	371	0.400
RCMT 25	372	0.450
RCMX 20	RF1	0.225
RCMX 25	RF1	0.275
RCMX 20	RM1	0.250
RCMX 25	RM1	0.350
RCMX 25	RM2	0.425
RCMX, RCMH 32	RM2	0.450
RCMT 16	RM3	0.350
RCMT 25	RM3	0.400
RCMX 28	RR2	0.450
RCMX, RCMH 32	RR2	0.450
RCMT 30	RR4	0.450
RCUM 30	RR7	0.450

The most problematic area of the machining process is in the radius between the treat and the flange. Round inserts need to cope with higher forces and needs to remove more material because almost the whole ¼ of the insert is wrapped by the workpiece. We recommend decreasing the feed by 30% in this area.

Influences to cutting process:

- Cutting conditions
- Geometry and micro-geometry
- Cutting material
- Workpiece hardness (250 – 340 HB)
- Cooling
- Machine power and rigidity



CHIPBREAKER RECOMMENDATIONS

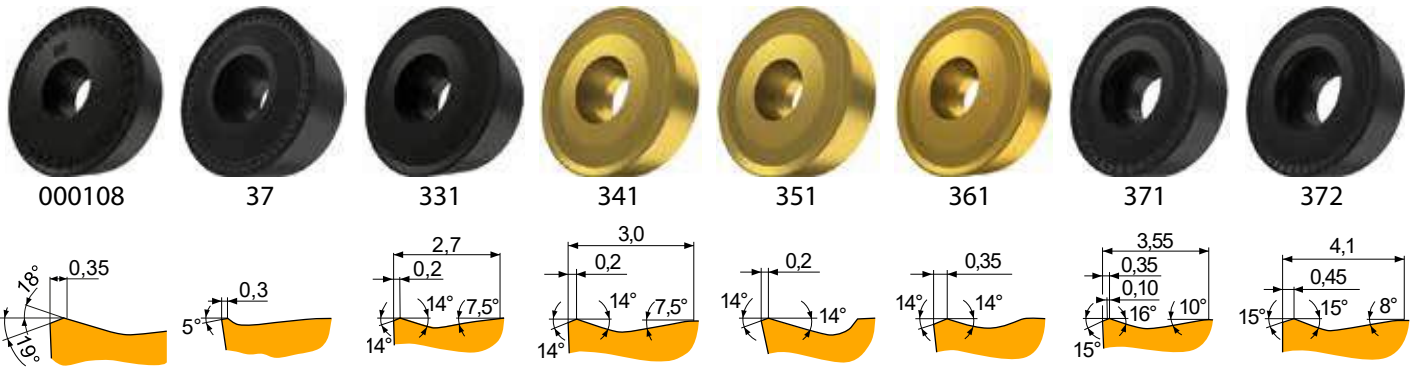

000108

- Chip-breaker for semi-rough to rough machining, and continuous to interrupted cuts.
- For depth of cuts from 2 mm to 8 mm and feeds from 0.8 mm/rev. to 1.6 mm/rev.
- Available on insert RCMX 3209MO

37

- Chip-breaker for semi-rough to heavy-rough machining, and continuous to interrupted cuts.
- For depth of cuts from 0.5 mm to 6 mm and feeds from 0.4 mm/rev. to 1.2 mm/rev.
- Available on inserts RCMT 1606MO, RCMX 1606MOS, RCMX 2006MO and RCMX 2507MO

331

- Chip-breaker suitable for semi-rough to heavy-rough machining, and continuous to interrupted cuts.
- For depth of cuts from 1 mm to 4 mm, feeds from 0.4 mm/rev. to 1.2 mm/rev.
- Available on insert RCMX 1606MOS

341

- Chip-breaker for semi-rough to heavy-rough machining, and continuous to interrupted cuts.
- For depth of cuts from 1 mm to 6 mm and higher feeds from 0.4 mm/rev. to 1.2 mm/rev.
- Available on insert RCMX 2006MO

351

- Chip-breaker suitable for semi-rough to heavy-rough machining, and continuous to interrupted cuts.
- For depth of cuts from 1 mm to 6 mm and feeds from 0.3 mm/rev. to 1.2 mm/rev.
- Available on insert RCMX 2507MO

361

- Chip-breaker suitable for rough to heavy-rough machining and continuous to heavy interrupted cuts.
- For depth of cuts from 3 mm to 8 mm and feeds from 0.8 mm/rev. to 1.6 mm/rev.
- Available on insert RCMX 3209MO

371

- Chip-breaker suitable for semi-rough to heavy-rough machining, and continuous to interrupted cuts.
- For depth of cuts from 1 mm to 5 mm and feeds from 0.2 mm/rev. to 1.2 mm/rev.
- Available on insert RCMT 2006MOS

372

- Chip-breaker for semi-rough to heavy-rough machining, continuous to interrupted cuts.
- For depth of cuts from 1 mm to 6 mm and feeds from 0.2 mm/rev. to 1.2 mm/rev.
- Available on insert RCMT 2507MOS

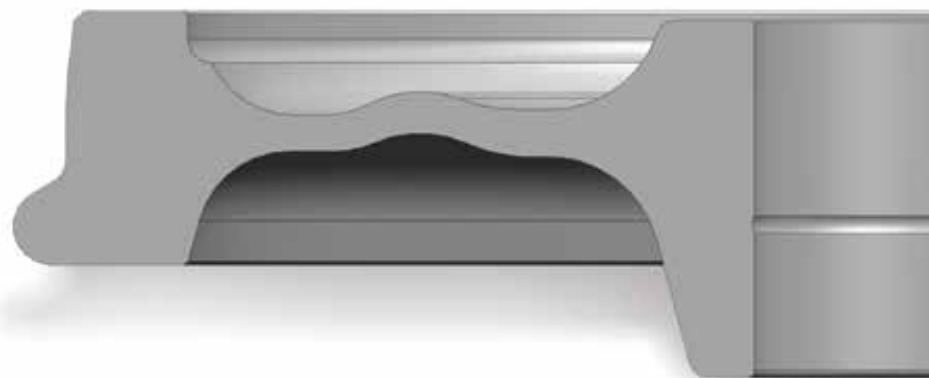



CHIPBREAKER RECOMMENDATIONS

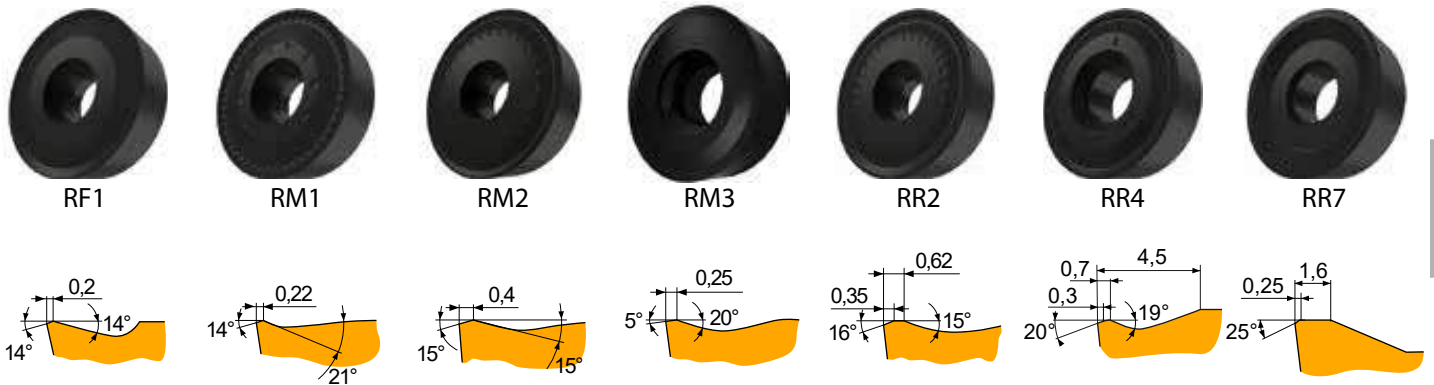

RF1

- **FIRST CHOICE** for finish machining
- Chip-breaker suitable for finish to semi-rough machining, and continuous to interrupted cuts.
- For depth of cuts from 1 mm to 7 mm and feeds from 0.45 mm/rev. to 1.25 mm/rev.
- Available on inserts RCMX 2006MO and RCMX 2507MO

RM1

- Chip-breaker for finish to rough machining, and continuous to interrupted cuts.
- For depth of cuts from 0.5 mm to 8 mm and feeds from 0.5 mm/rev. to 1.4 mm/rev.
- Available on inserts RCMX 2006MO, RCMX 2507MO

RM2

- **FIRST CHOICE** for semi-rough to rough machining
- Chip-breaker for semi-rough to rough machining, and continuous to interrupted cuts.
- For depth of cuts from 2 mm to 8 mm and feeds from 0.7 mm/rev. to 1.5 mm/rev.
- Available on inserts RCMH 3209MO, RCMX 2507MO and RCMX 3209MO

RM3

- Chip-breaker for semi-rough to rough machining, and continuous to interrupted cuts..
- For depth of cuts from 0.5 mm to 6 mm and feeds from 0.3 mm/rev. to 0.9 mm/rev.
- Available on inserts RCMT 1606MOE and RCMT 2507MOE

RR2

- **FIRST CHOICE** for rough to heavy-rough machining
- Chip-breaker for semi-rough to heavy-rough machining, and continuous to interrupted cuts.
- For depth of cuts from 4 mm to 8 mm and feeds from 0.8 mm/rev. to 1.6 mm/rev.
- Available on inserts S-RCMX 2809MO, RCMH 3209MO and RCMX 3209MO

RR4

- Chip-breaker for semi-rough to heavy rough machining, and continuous to interrupted cuts.
- For depth of cuts from 4 mm to 8 mm and feeds from 0.8 mm/rev. to 1.6 mm/rev.
- Available on inserts RCMT 3009MO, RCMT30-1438000

RR7

- Chip-breaker for heavy rough machining, and continuous to interrupted cuts.
- For depth of cuts from 4 mm to 8 mm and feeds from 0.8 mm/rev. to 1.6 mm/rev.
- Available on insert RCUM 3010MO

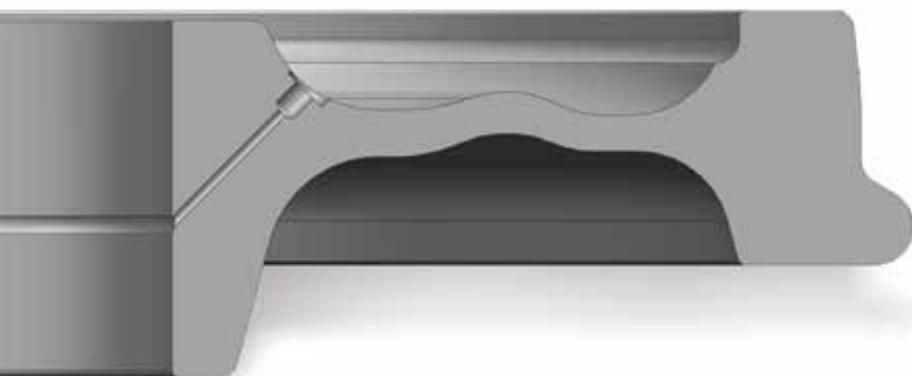



PRODUCTION PROCESS EXAMPLE

Example of the machining process for the new railway wheel on the vertical turning lathe. The process is done in several steps in two workpiece positions due to the fact that the wheel is machined from both sides. Two tools work at the same time to make the process more efficient. Roughing operations are done with insert RCMX 32 or RCMT 30, while the finishing operation is done with smaller insert sizes like RCMX 16, 20 or 25.

1. SETUP														
Step Nr.	Tool Nr.	Operation	Left tool					Tool Nr.	Operation	Right tool				
			Ø D (mm)	Length (mm)	Vc (m/min)	n (1/min)	f (mm/rev)			Ø D (mm)	Length (mm)	Vc (m/min)	n (1/min)	f (mm/rev)
1	T03	6-7, roughing $\phi 740\text{-}\phi 515$	628	198	90	46	1.8	T01	1-2, cutting $\phi 840\text{-}\phi 730$	800	92	115	46	1.2
2	T03	8-7, roughing $\phi 290\text{-}\phi 515$	403	198	110	87	1.8	T01	1-3, roughing	870	60	185	68	1.2
3	T04	6-7, finishing $\phi 740\text{-}\phi 515$	628	198	134	68	1.2	T02	1-3, finishing	870	60	237	87	1.2
4	T04	8-7, finishing $\phi 290\text{-}\phi 515$	403	198	168	133	1.2	T02	4-5, finishing $\phi 290\text{-}\phi 190$	240	60	100	133	1.2

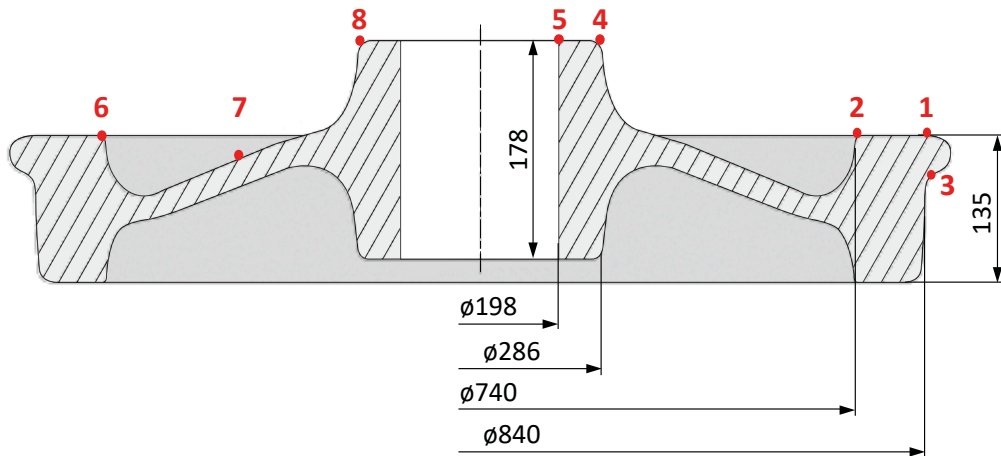

2. SETUP														
Step Nr.	Tool Nr.	Operation	Left tool					Tool Nr.	Operation	Right tool				
			Ø D (mm)	Length (mm)	Vc (m/min)	n (1/min)	f (mm/rev)			Ø D (mm)	Length (mm)	Vc (m/min)	n (1/min)	f (mm/rev)
1	T03	7-8, roughing $\phi 738\text{-}\phi 513$	626	162.5	90	46	1.8	T01	1-2, cutting $\phi 840\text{-}\phi 740$	790	60	115	46	1.2
2	T03	9-8, roughing $\phi 288\text{-}\phi 513$	401	162.5	60	48	1.8	T01	1-3, roughing	840	112	180	68	1.2
3	T04	7-8, finishing $\phi 738\text{-}\phi 513$	626	162.5	187	95	1.2	T02	1-3, finishing	840	112	250	95	1.2
4	T04	9-8, finishing $\phi 288\text{-}\phi 513$	401	162.5	167	133	1.2	T02	4-5, finishing $\phi 290\text{-}\phi 190$	240	60	100	133	1.2
								T05	5-6, roughing bore hole	197	188	80	129	1.2

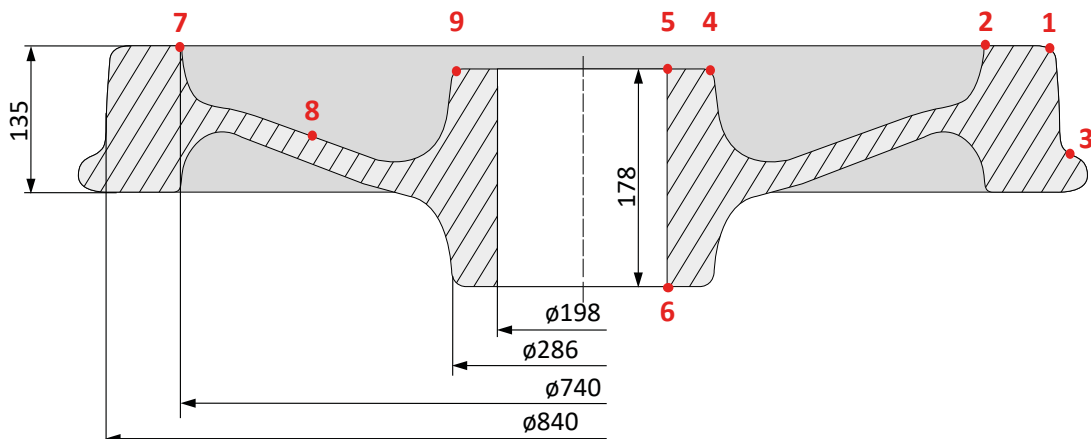



PRODUCTION PROCESS – TOOL LIST

Turning

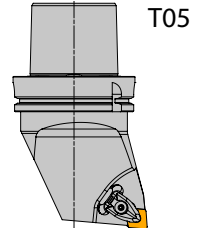
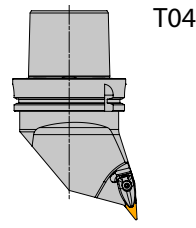
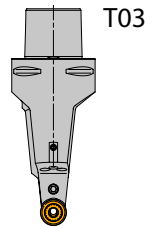
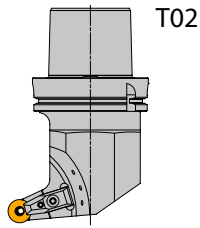
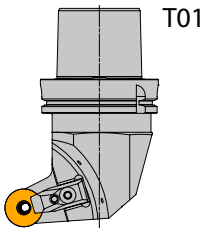

T01

- C10-DRGCL-K32
- Tool for roughing of wheel rim face, tread and the flange
- RCMX 3209MO

T02

- C10-PRGCL-K20(25)
- Tool for finishing of the tread, flange and the hub face
- RCMX 2006MO (RCMX 2507MO)

T03

- C10-PRDCN-K32
- Tool for roughing of the wheel center (both sides)
- RCMX 3209MO

T04

- C10-SVJCR-K16
- Tool for finishing of the wheel center
- VNMG 160408

T05

- C10-DCLNR-K16
- Tool for machining of the hub, bore hole
- CNMM 160616



Drilling & tapping

A941



- PFX HSS-E (5 % Cobalt) Long Series Drill, AlcronaTop Coated
- High performance drill, able to produce high quality and accurate holes at high speeds and feeds (H10 hole tolerance). Self-centering 130° point angle and special parabolic flute design. Suitable for many materials. Alcrona-TOP coating improves performance and extends the tool life.

A976



- PFX HSS-E (5 % Cobalt) Extra Long Series Drill (DIN 1869 Series 1), Bright Finish
- Recommended for drilling very deep holes or for applications where extra reach is needed. Specially designed parabolic flutes eliminate the need to drill deep holes in short steps (pecking).

R453



- FORCE X Solid Carbide 5XD Drill with Coolant Feed, TiAlN Coated

E258



- HSS-E-PM 15° Spiral Flute Machine Tap, Metric, DIN Standard
- Slow spiral flute tap for up to 1.5xD deep blind holes. With 15° helix for more stability threading in harder and higher strength steels. The reduced shank increases the reach of the tap.



Holders with capto back-end upon customer request.



RAILWAY WHEEL RECONDITIONING



RAILWAY WHEEL RECONDITIONING

Wheels are the most stressed components of railway vehicles. They carry axle loads of up to 25 tons and more. They guide the train on the tracks through curves and switches and are subjected to constant wear process. Once in a while a train wheel's profile must be renovated due to passengers' safety and comfort. All failures such as skid flats, scale, rust and rolling contact fatigue has to be removed.

Dormer Pramet offers a complete line of tools for wheel re-turning. Holders for Hegenscheidt, Rafamet and other machines are equipped with exchangeable cartridges with protective cemented carbide shim. Our insert geometries and grades can satisfy all customer needs. Inserts LNMX 19, LNMX 30, SNMX 19 and CNMX 19 with chipbreakers RR, RM ensure high material removal, whereas RF, TF make a perfect surface.

Main benefits:

- Exchangeable cartridges
- Cemented carbide shim
- High variety of insert shapes: CNMX, LNMX, LNMT, RNGX, ROEX, RPUX, SNMX, TNMN
- Chipbreakers for every cutting conditions: DF, DM, TF, TF1, TF2, RF, RM, RR, RR2
- Wide range of grades: T9310, T9315, T9325, T5305, T5315
- Rigid clamping by lever or excentre screw
- Easy insert or cartridge exchange





CHIPBREAKER RECOMMENDATIONS

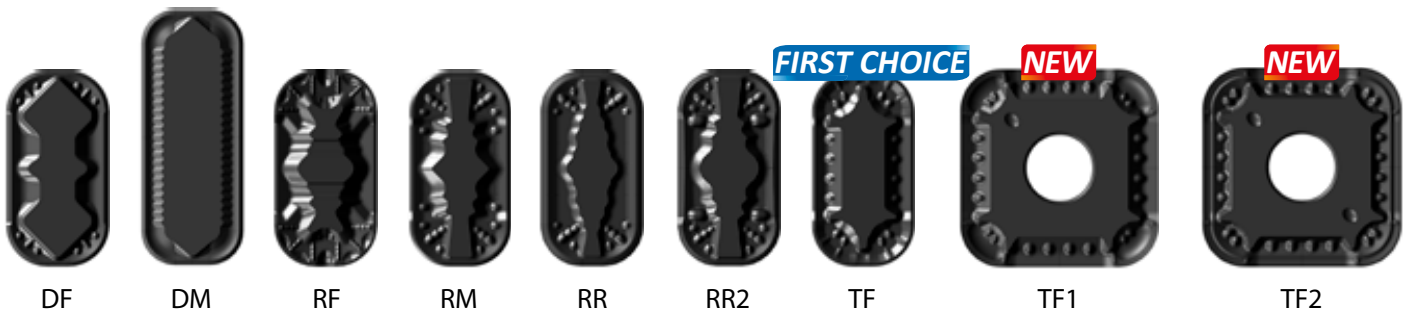

DF

- Chip-breaker for finishing and roughing operations
- For depth of cuts from 1 mm to 6 mm and higher feeds from 0.6 mm/rev. to 1.5 mm/rev.
- Optimum for lower to middle cutting speeds
- Available on insert LNMX 19

DM

- Chip-breaker for finishing and roughing operations
- For depth of cuts from 3 mm to 12 mm and higher feeds from 0.8 mm/rev. to 1.5 mm/rev.
- Optimum for lower to middle cutting speeds
- Available on insert LNMX 30

RF

- Chip-breaker suitable for finishing operations
- For depth of cuts from 2 mm to 8 mm, feeds from 0.4 mm/rev. to 1.1 mm/rev.
- Suitable for middle cutting speeds
- Available on inserts LNMX 19, LNMX 30, SNMX 19 and CNMX 19

RM

- Chip-breaker for finishing and roughing operations
- For depth of cuts from 2 mm to 10 mm and higher feeds from 0.45 mm/rev. to 1.8 mm/rev.
- Optimum for lower to middle cutting speeds
- Available on inserts LNMX 19 and LNMX 30

RR

- Chip-breaker suitable for roughing to heavy-roughing operations
- For depth of cuts from 2 mm to 12 mm and higher feeds from 0.75 mm/rev. to 1.8 mm/rev.
- Optimum for middle and higher cutting speeds
- Available on inserts LNMX 19 and LNMX 30

RR2

- Chip-breaker suitable for roughing to semi-roughing operations
- For depth of cuts from 2 mm to 6 mm and feeds from 0.6 mm/rev. to 1.8 mm/rev.
- Optimum for middle and higher cutting speeds
- Available on insert LNMX 19

TF

- **FIRST CHOICE**
- Versatile chip-breaker for finishing up to roughing operations
- Excellent chip flow
- For depth of cuts from 2 mm to 12 mm and feeds from 0.4 mm/rev. to 1.5 mm/rev.
- Optimum for middle cutting speeds
- Available on inserts LNMX 19, LNMX 30, SNMX 19 and CNMX 19

TF1

- **NEW DESIGN**
- Chip-breaker for finishing operations
- For small depth of cuts from 0.5 mm up to 7 mm
- used on S-SNMX 19 and S-CNMX 19

TF2

- **NEW DESIGN**
- Chip-breaker for finishing operations
- For small depth of cuts from 0.5 mm up to 7 mm
- used on S-SNMX 19 and S-CNMX 19



OTHER SOLUTIONS FOR WHEEL ROCONDITIONING



BNMX 201540

BNMX 201540

- Double sided insert with chip-breaker
- For depth of cuts from 2 mm to 10 mm and higher feeds from 0.6 mm/rev. to 1.5 mm/rev.

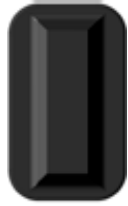

-

LNMT 311240 **FIRST CHOICE**



M

LNMT 311240

- Chip-breaker for finishing and roughing operations
- For depth of cuts from 4 mm to 15 mm and higher feeds from 0.5 mm/rev. to 1.5 mm/rev.

LNMT 311240-M

- **FIRST CHOICE**
- Chip-breaker suitable for finishing to heavy-roughing operations
- Very good chip-forming
- For depth of cuts from 2 mm to 15 mm and higher feeds from 0.5 mm/rev. to 1.5 mm/rev.



R

LNMT 311240-R

- Insert with a lower middle boss to reduce the cutting forces
- For depth of cuts from 4 mm to 15 mm and higher feeds from 0.5 mm/rev. to 1.5 mm/rev.



RPUX

RPUX

- Available versions: RPUX 3010MO and RPUX 2710MO
- Single sided round inserts with chip-breaker
- For depth of cuts from 2 mm to 7 mm and feeds from 0.6 mm/rev. to 1.2 mm/rev.
- Suitable for lower cutting speeds.



TNMN

TNMN

- Available in sizes TNMN 33 and TNMN 39
- Suitable for older machines
- Should be used together with separate chip-breaker TU14-2500612
- For depth of cuts from 2 mm to 10 mm, with higher feeds from 1.0 mm/rev. to 1.5 mm/rev.

TU14-2500612

- Chip-breaker for TNMN inserts



TU14-2500612



ROEX 15



RNGX 12



S-RNEX 15



S-RNEX 16

ROEX 15

- Insert for reconditioning of railway wheels by milling
- Single sided insert with square hole for proper fixing and easy indexing
- For depth of cuts up to 5 mm.

RNGX 12, RNEX 15 & RNEX 16

- Insert for reconditioning of railway wheels by milling
- Double sided insert
- For depth of cuts up to 5 mm.



WHEELS RE-TURNING ASSORTMENT - SPECIALS

EXAMPLE OF MACHINING – RE-TURNING OF RAILWAY WHEELS

1. RE-TURNING OF HARD WORN WHEEL 2 holders in machine

Holder description (2 cart.): DKTR 5555 X C2
 Cartridge (right): KTP-LANR 30
 Insert: LNMX 301940SN-RM, T93xx
 Cartridge (left): KTP-LFNL 19
 Insert: LNMX 191940SN-RM, T93xx
 Holder description (1 cart.): DKTR 5555 X C1
 Cartridge (right): KTP-LANR 30
 Insert: LNMX 301940SN-TF, T93xx

Cutting conditions:

cutting speed: $v_c = 50 - 70$ m/min
 feed per revolution: $f = 0.55 - 0.8$ mm/rev.
 axial cutting depth: $a_p = 3 - 10$ mm

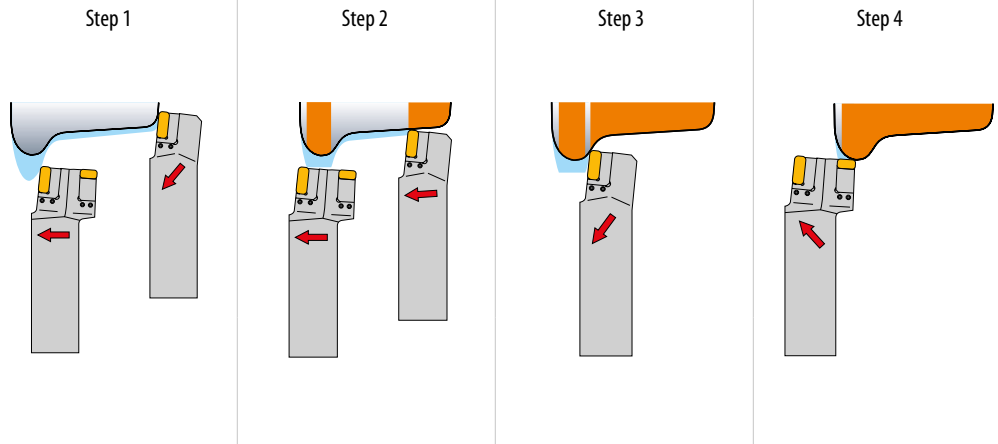

2. RE-TURNING OF HARD WORN WHEEL 1 holder in machine

Holder description (2 cart.): DKTR 5055 X A2
 Cartridge (right): KTP-LANR 30
 Insert: LNMX 301940SN-RM, T93xx
 Cartridge (left): KTP-LFNL 19
 Insert: LNMX 191940SN-RM, T93xx

Cutting conditions:

cutting speed: $v_c = 80 - 90$ m/min
 feed per revolution: $f = 0.4 - 1.0$ mm/rev.
 axial cutting depth: $a_p = 3 - 5$ mm

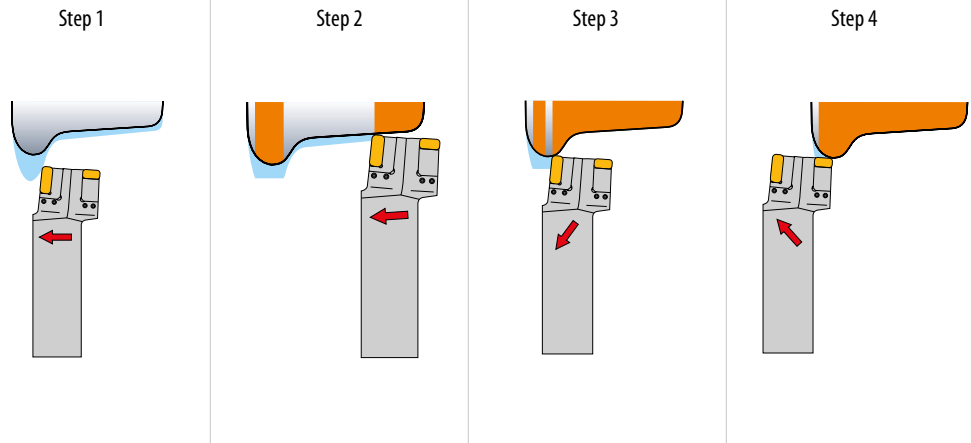

3. RE-TURNING OF LESS WORN WHEEL 1 holder in machine

Holder description (2 cart.): DKTR 5050 X D2
 Cartridge (right): KTP-LANR 30
 Insert: LNMX 301940SN-RF, T93xx
 Cartridge (left): KTP-LFNL 19
 Insert: LNMX 191940SN-RF, T93xx

Cutting conditions:

cutting speed: $v_c = 80 - 90$ m/min
 feed per revolution: $f = 0.4 - 1.0$ mm/rev.
 axial cutting depth: $a_p = 3 - 5$ mm

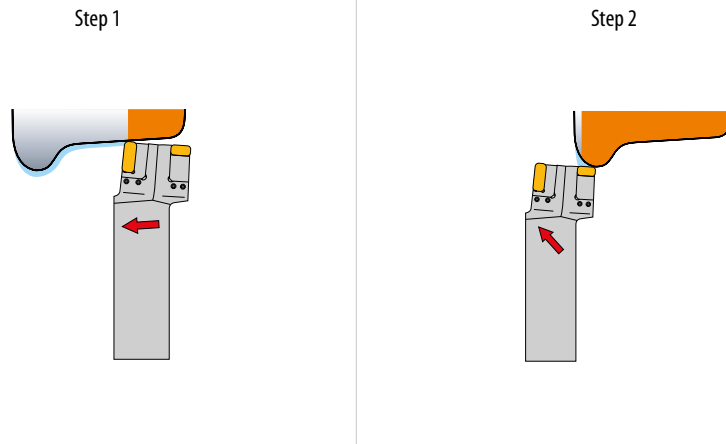

4. RE-TURNING OF WHEEL – 1ST PROFILE 1 holder in machine

Holder description (2 cart.): DKTR 5050 X D2
 Cartridge (right): KTP-SANR 19
 Insert: SNMX 191140SN-TF, T93xx
 Cartridge (left): KTP-SFNL 19
 Insert: SNMX 191140SN-TF, T93xx

Cutting conditions:

cutting speed: $v_c = 60 - 70$ m/min
 feed per revolution: $f = 0.4 - 1.0$ mm/rev.
 axial cutting depth: $a_p = 2 - 4$ mm

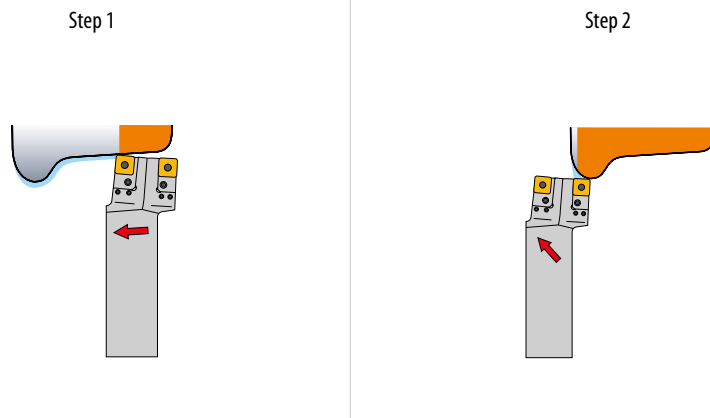



WHEELS RE-TURNING ASSORTMENT - SPECIALS

Tailor-made holders with several types of back-ends

Possibility of special types of holders according to customer request. Various types of back-ends like CAPTO, quadrates with longer overhang and atypical flanges that fits to customer's supports. All holder's pockets are compatible with standard Dormer Pramet cartridges for any kind of insert's shapes.

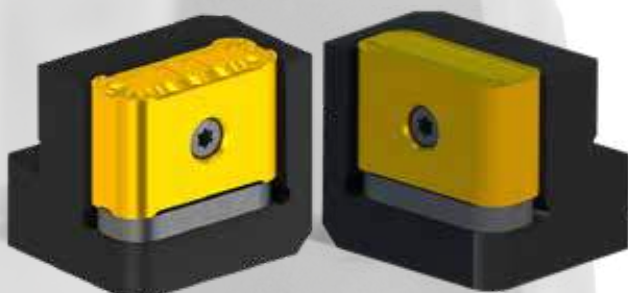

Special cartridges for LNMX 301940 tangential inserts

KTP-LAN(R)L 30... cartridges for turning of flanges with high depth of cuts. Cartridges are protected with cemented carbide shim. Inserts clamping by eccentric screw.

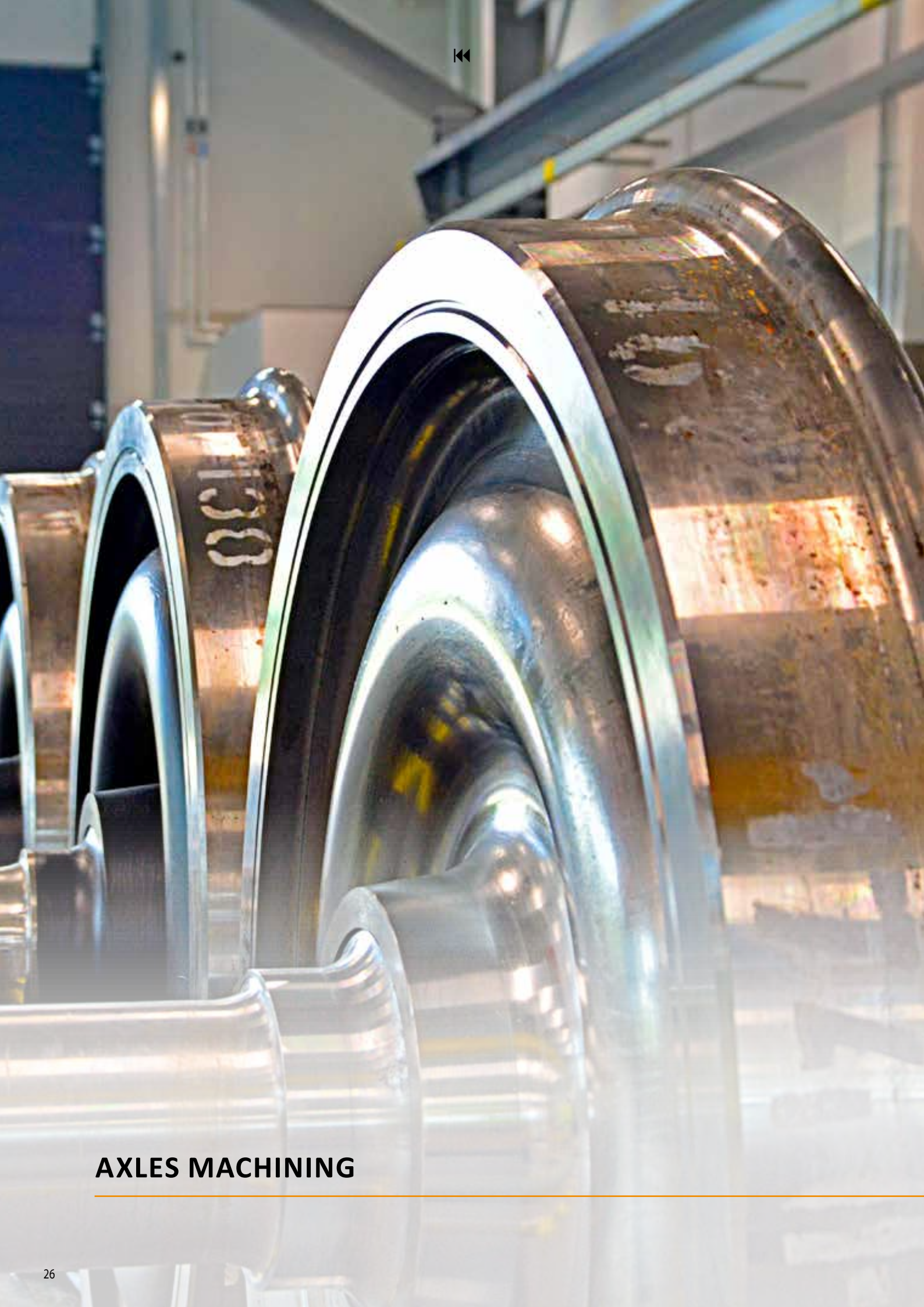

AXLES MACHINING



AXLES MACHINING

Axles are parts of the wheel-sets where the wheels are pushed onto. There are axles for locomotives, freight cars, passenger cars, high-speed rails, urban rails, industrial and other engineering vehicles.

Axles are made of carbon steel, alloy steel, stainless steel or other special materials. Axles are a product which require great responsibility and variability in the design and manufacturing process according to the different trends followed in different countries.

The majority of these parts are manufactured from forged pieces and a major focus is that our tools maximize process reliability and the quality of roughing and finishing operations. New axles are machined using a lathe to a standardized shape. Most of the machining is done by turning operations, but there are also operations of drilling and tapping.

Dormer Pramet offers standard assortment of roughing and finishing turning tools. Large, negative inserts with chip-breakers are suitable for high material removal where rigidity of inserts is vital. On the other hand, smaller positive inserts with sharp geometry are used for achieving a fine surface quality.

Among the standard assortment of solid drills, indexable drills, Hydra drills and taps, we can also offer its special tailor-made variants.





MACHINING PROCESS – EXTERNAL TURNING

External turning, semi-roughing to super heavy-roughing operations



Turning of the seat for wheel
 Holders PCLN(RL) 4040 S 25 and PCBN(RL) 4040 S 25 with rigid single sided CNMM 250924 inserts with various available geometries for semi-rough to super heavy-rough machining and continuous to interrupted cuts. All available in grades for material groups P, M, K and S.



	923	HR	NR2	OR
f	0.45-1.5	0.5-1.4	0.2-1.6	0.25-1.7
a_p	3.0-16.0	5.0-14.0	1.0-16.0	2.0-16.0

Turning of the center part

Holders PSBN(RL) 4040 S 25 with rigid single sided SNMM 250924 inserts with various available geometries for semi-rough to super heavy-rough machining and continuous to heavy interrupted cuts. All available in grades for material groups P, M, K and S.

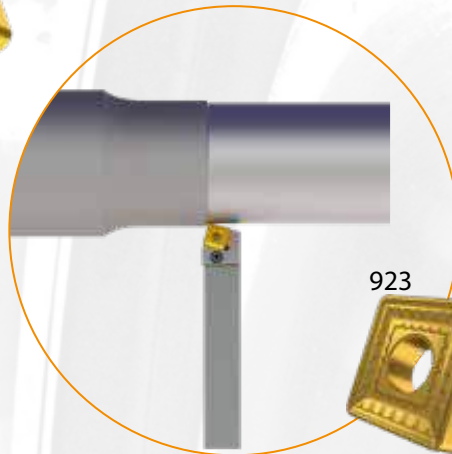

External turning, finishing operations

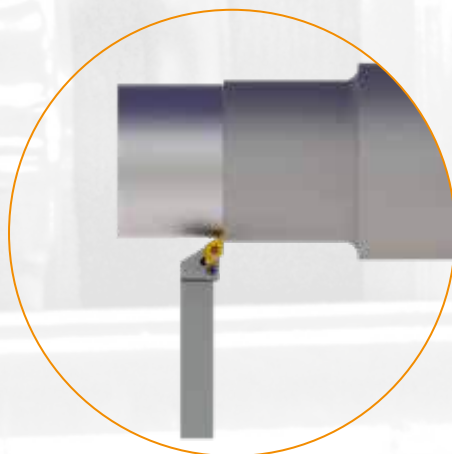

Finishing of wheel seats and axle center part

Holders PDJN(RL) 2525 M 15 with rigid negative double sided DNMG 150612 inserts with various available geometries for semi-rough to finish machining and continuous cuts.

Holders SRDCN 2525 M 12 with positive single sided RCMT 12 1204MO inserts with various available geometries for rough to fine-finish machining and continuous to interrupted cuts.



	FM	M	MR	UR
f	0.1-1.0	0.17-0.80	0.2-0.75	0.15-1.0
a_p	0.3-5.0	0.8-5.0	0.5-5.0	0.5-5.0

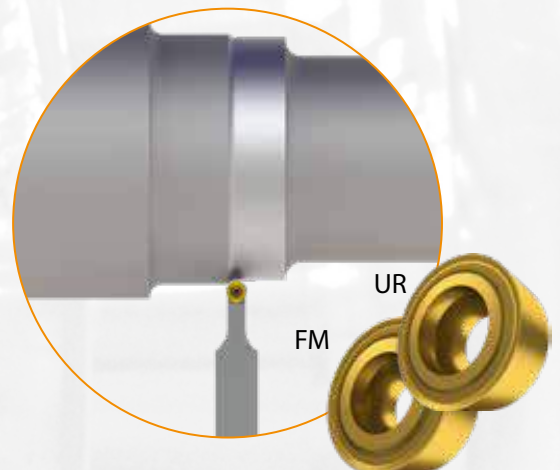



MACHINING PROCESS – MILLING, DRILLING & TAPPING



HYDRA: High performance replaceable head drills

Interchangeable solid carbide head drills for high performance machining of steels, stainless steels and cast iron. Fail-safe head location can be changed without ejecting the drill from the machine. Available with coolant feed and a choice of HSS bodies from 1.5xD for improved rigidity in shallow hole and plate drilling, through to 12xD for deeper hole applications. Available in \varnothing 12.0 – \varnothing 42.0 mm.



R457: FORCE X Solid Carbide Drill with Coolant Feed

High performance drill, capable of producing high quality and accurate holes even at high speeds and feeds (H9 hole tolerance). Self centering 140°. TiAlN coating increases surface hardness and improves tool life at high RPM. Available in \varnothing 3.0 – \varnothing 20.0 mm.



G138: HSS Taper Shank Countersink with 90° Angle, Bright Finish

A 90° Countersink designed for chamfering standard fastener holes and removing burrs from drilled holes. Taper shank design allows the tool to be used in machine applications where it is held directly in the spindle. Suitable to chamfer holes in many materials. Available in \varnothing 25.0 – \varnothing 80.0 mm.



E258: HSS-E-PM 15° Spiral Flute Machine Tap, Metric, DIN376 Standard

Slow spiral flute tap for up to 1.5xD deep blind holes. With 15° helix for more stability threading in harder and higher strength steels. The reduced shank increases the reach of the tap. (M4 – M36).

SHN09C, ECON HN, 45° Face Mill with Double Negative Design and Internal Coolant for milling of axles faces

Highly productive 45° face mill utilising double sided HN..09 style inserts with APMX of 5 mm. Roughing, finishing and chamfering. Economical insert with 12 cutting edges. Arbor mounting only, in range from \varnothing 50 up to to \varnothing 315 mm.





←

STATIONARY & DYNAMIC RAIL MILLING

RAIL MILLING

Rail treatment

There are several reasons for rail treatment. Primarily it is an issue of operational safety. On account of the mechanical stresses in wheel/rail contact, cracks (head checks) appear on the surface of the rail. These have to be removed before they spread and destroy the rail.

Dynamic rail milling

When renovating railway lines there are generally two preferred options, grinding or dynamic milling. Compared to grinding, the high-speed re-profiling of a line represents significant time and financial savings. Specially designed trains, operating at a constant speed of 700 meters per hour machine the existing track profile. By removing millimeters of metal from the damaged surface, the track is restored to its original condition. With each application, the first cutter roughens the surface, the second one finishes it, and the two units act on both rails simultaneously.

The operation provides a high-quality surface finish, while metal chips produced during the milling stage are transferred to a nearby container, ensuring no debris is left on the track. This ‘on the-move’ application requires specialized equipment to achieve optimum results, such as train machine tools designed to carry dynamic rail milling cutters and inserts. An increasing number of these are being produced by leading global manufacturers as demand from railway organizations and government bodies for track maintenance increases.

One of the big advantages of rail milling is the possibility of changing rail profiles. Profiles for high-speed trains and for operation at speeds up to 160 km/h can only be changed through milling. Milling is also necessary to reduce the amount of noise generated by trains and to correct the track gauge.

Stationary rail milling

Stationary rail milling is an operation that is done in a workshop. Rails with a usual length of 120 m are pushed through the stationary machine tool, where a similar cutter to the one used for dynamic rail milling is machining a rail head to ensure a good surface quality as well as a modification of an overall rail height.





DYNAMIC RAIL MILLING CUTTERS

Dormer Pramet offers several designs of milling cutters that can be used for rail milling. They differ in size (diameters 290 mm, 600 mm and 900 mm), in clamping system (usage for different machine tools, cutters \varnothing 600 mm are suitable for most of the Linsinger trains and trucks) and in the machined profile (depends on the rail profile).

All our solutions have common features and advantages. All cutters are designed as an assembly of universal tool body and interchangeable cartridges with indexable tangential inserts.

The advantage of this solution is an easy exchange of the machined profile just by changing the cartridge type or even just by changing some inserts in the cartridge or exchanging of just some cartridges in case of their damage during the machining process. This possibility saves money and decreases downtime and the storage space requirements.

Main components

Tool body – There is always one universal tool body for each cutter diameter that can be used for the right-hand and the left-hand cutter as well as for roughing and finishing operation. Connection cone and facing and seats for cartridges are produced with very high precision to ensure minimum overall radial and axial run-out.

Cartridges – Right-hand and left-hand cartridges are fixed to the tool body by the screw(s). Some of the cartridges can be used for machining more than one type rail profile (e.g., cartridges CA-502-000 and CA-503-000 can be used for 60E1, 54E1 and 46E3 profiles with rail inclination 1:40).

Indexable inserts – Reliability of inserts is the key for machining of rails where every stop of the train can cause a lot of problems. The reliability of our inserts is ensured by the insert size (IC = 15 mm, s = 7.94 mm) and by the usage of reliable PVD grades (7310 and M8310). Flat inserts are having 8 cutting edges while inserts with radiuses are having 4 cutting edges.

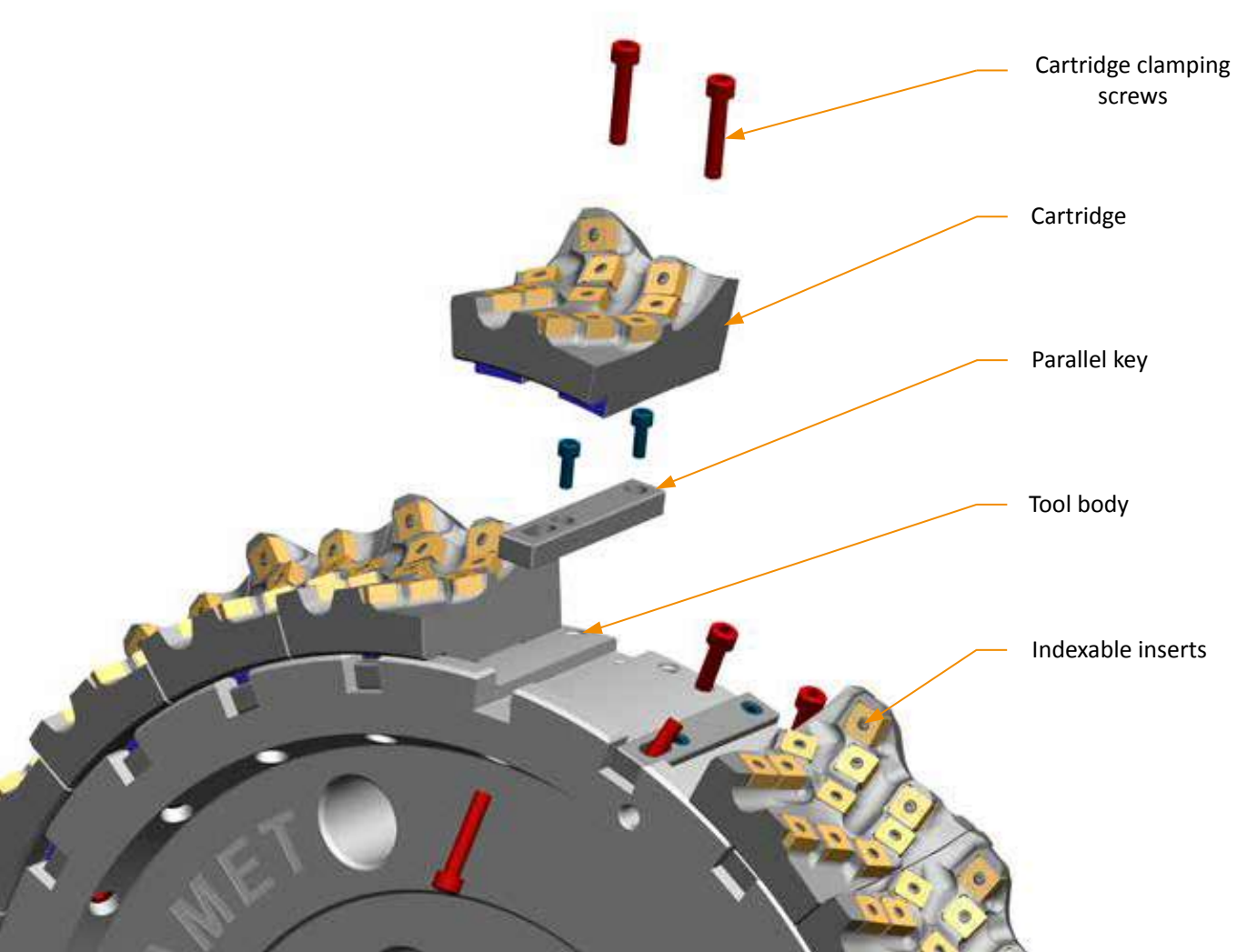



MILLING CUTTERS OVERVIEW

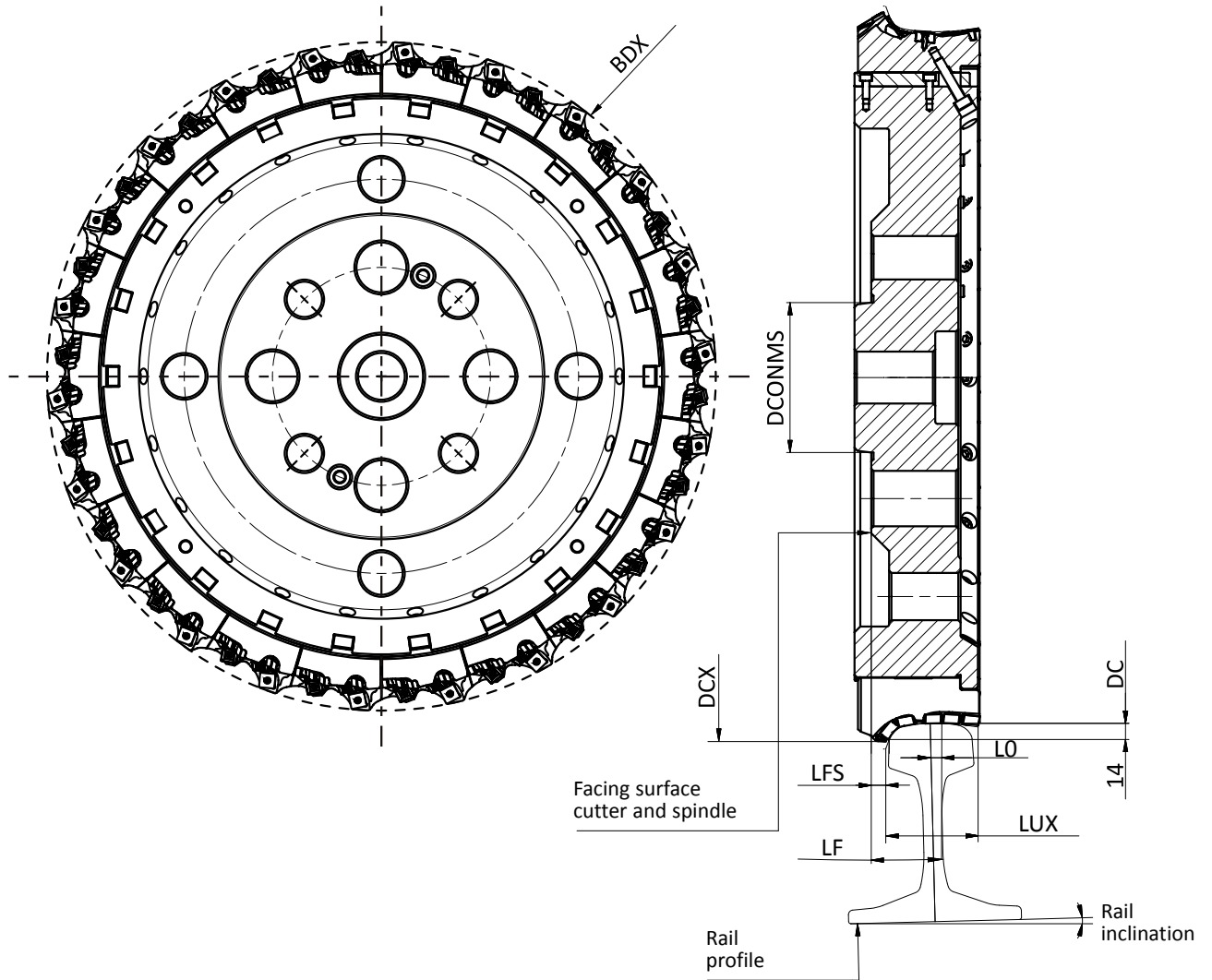

Product	Rail profile	Rail inclination	HAND	DC (mm)	DCX (mm)	DCONMS (mm)	BDX (mm)	LF (mm)	LFS (mm)	LUX (mm)	L0 (mm)		CICT
S-290R10-CA526-000809	60E1	1:20	R	290	332.6	135.00	336.3	64.0	29.00	80.30	11.49	10	110
S-600R22-CA502-000697	60E1	1:40	R	600	643.8	130.00	650.0	58.6	15.60	78.90	7.50	22	242
S-600L22-CA503-000698	60E1	1:40	L	600	643.8	130.00	650.0	58.6	15.60	78.90	7.50	22	242
S-600R22-CA438-000546	60E1	1:40	R	600	643.0	130.00	650.1	57.8	14.77	79.30	7.50	22	176
S-600L22-CA439-000547	60E1	1:40	L	600	643.0	130.00	650.1	57.8	14.77	79.30	7.50	22	176
600R22-CA252-657-130	60E2	1:40	R	600	643.2	130.00	644.5	56.1	15.60	80.10	5.00	22	242
600L22-CA253-657-230	60E2	1:40	L	600	643.2	130.00	644.5	56.1	15.60	80.10	5.00	22	242
600R22-CA252-657-130	60E2 AHC	1:40	R	600	643.2	130.00	644.5	56.1	15.60	80.10	5.00	22	242
600L22-CA253-657-230	60E2 AHC	1:40	L	600	643.2	130.00	644.5	56.1	15.60	80.10	5.00	22	242
S-600R22-CA502-000697	54E1	1:40	R	600	643.8	130.00	650.0	57.7	15.60	78.90	7.50	22	242
S-600L22-CA503-000698	54E1	1:40	L	600	643.8	130.00	650.0	57.7	15.60	78.90	7.50	22	242
S-600R22-CA491-000629	54E5	1:40	R	600	643.8	130.00	650.0	54.2	15.60	78.90	4.17	22	242
S-600L22-CA492-000630	54E5	1:40	L	600	643.8	130.00	650.0	54.2	15.60	78.90	4.17	22	242
S-600R22-CA502-000697	46E3	1:40	R	600	643.8	130.00	650.0	59.5	15.60	78.90	7.50	22	242
S-600L22-CA503-000698	46E3	1:40	L	600	643.8	130.00	650.0	49.5	15.60	78.90	7.50	22	242
S-900R34-000445	60 TBT2344	1:40	R	900	948.2	285.78	945.0	69.0	26.54	78.83	7.50	34	374
S-900L34-000446	60 TBT2344	1:40	L	900	948.2	285.78	945.0	69.0	26.54	78.83	7.50	34	374



DYNAMIC RAIL MILLING ASSORTMENT

Assortment of milling cutters and spare parts

RAIL PROFILE	RAIL INCLINATION	CUTTER ASSEMBLY	HAND	TOOL BODY	CARTRIDGE		CARTRIDGE CLAMPING SCREW		PARALLEL KEY		PARALLEL KEYS SCREW		INSERT		INSERT'S SCREW	
					Designation	PCS	Designation	PCS	Designation	PCS	Designation	PCS	Designation	PCS	Designation	PCS
60E1	1:20	S-290R10-CA526-000809	R	S-220X10-000808	CA-526-000	10	CA-526-000	30	PK-096-000	10	M6×16 ISO 4762 A2	20	US 64014-T20P	110		
60E1	1:40	S-600R22-CA502-000697	R		CA-502-000											
60E1	1:40	S-600L22-CA503-000698	L		CA-503-000											242
60E1	1:40	S-600R22-CA438-000546	R		CA-438-000											154
60E1	1:40	S-600L22-CA-439-000547	L		CA-439-000											22
60E2	1:40	600R22-CA252-657-130	R		CA-252-000											
60E2	1:40	600L22-CA253-657-230	L		CA-253-000											
60E2 AHC	1:40	600R22-CA252-657-130	R	600X22-657	CA-252-000	22	M8×40 ISO 4762 12.9	66	PK-096-000	22	M6×16 ISO 4762 A2	44	For more information see table below.			242
60E2 AHC	1:40	600L22-CA253-657-230	L		CA-253-000											
54E1	1:40	S-600R22-CA502-000697	R		CA-502-000											
54E1	1:40	S-600L22-CA503-000698	L		CA-503-000											
54E5	1:40	S-600R22-CA491-000629	R		CA-491-000											
54E5	1:40	S-600L22-CA492-000630	L		CA-492-000											
46E3	1:40	S-600R22-CA502-000697	R		CA-502-000											
46E3	1:40	S-600L22-CA503-000698	L		CA-503-000											
60 TB2344	1:40	S-900R34-000445	R	S-790034-B00Y-000444	CA-431-000	34	M16×100 ISO 4762 12.9	34	PK-433-000	34	M8×16 ISO 4762 12.9	68				374
60 TB2344	1:40	S-900L34-000446	L		CA-432-000											

Inserts usage per profile

RAIL PROFILE	RAIL INCLINATION	CARTRIDGE	HAND	POCKET NR.										
				1	2	3...7	8	9			10		11	
					ROUGHING & FINISHING	ROUGHING & FINISHING	ROUGHING & FINISHING	ROUGHING	FINISHING	ROUGHING	FINISHING	ROUGHING	FINISHING	ROUGHING & FINISHING
60E1	1:20	CA-526-000	R	S-SNEX 15-2462000	S-SNEX 15-000953	S-SNEX 15-2462000	S-SNEX 15-2462000	S-SNEX 15-2462000	S-SNEX 15-000953	S-SNEX 15-000953	S-SNEX 15-000953	S-SNEX 15-000953	S-SNEX 15-2462000	S-SNEX 15-2462000
60E1	1:40	CA-502-000	R		S-SNEX 15-2462000	S-SNEX 15-2462000	S-SNEX 15-2462000	S-SNEX 15-2462000	S-SNEX 15-000953	S-SNEX 15-000953	S-SNEX 15-000953	S-SNEX 15-2462000	S-SNEX 15-2462000	
60E1	1:40	CA-503-000	L		S-SNEX 15-2462000	S-SNEX 15-2462000	S-SNEX 15-2462000	S-SNEX 15-2462000	S-SNEX 15-000953	S-SNEX 15-000953	S-SNEX 15-000953	S-SNEX 15-2462000	S-SNEX 15-2462000	
60E1	1:40	CA-438-000	R		S-SNEX 15-2462000	S-SNEX 15-2462000	S-SNEX 15-2462000	S-SNEX 15-2462000	S-SNEX 15-000953	S-SNEX 15-000953	S-SNEX 15-000953	S-SNEX 15-2462000	S-SNEX 15-2462000	
60E1	1:40	CA-439-000	L		S-SNEX 15-2462000	S-SNEX 15-2462000	S-SNEX 15-2462000	S-SNEX 15-2462000	S-SNEX 15-000953	S-SNEX 15-000953	S-SNEX 15-000953	S-SNEX 15-2462000	S-SNEX 15-2462000	
60E2	1:40	CA-252-000	R		S-SNEX 15-2462000	S-SNEX 15-2462000	S-SNEX 15-2462000	S-SNEX 15-2462000	S-SNEX 15-000953	S-SNEX 15-000953	S-SNEX 15-000953	S-SNEX 15-2462000	S-SNEX 15-2462000	
60E2	1:40	CA-253-000	L		S-SNEX 15-2462000	S-SNEX 15-2462000	S-SNEX 15-2462000	S-SNEX 15-2462000	S-SNEX 15-000953	S-SNEX 15-000953	S-SNEX 15-000953	S-SNEX 15-2462000	S-SNEX 15-2462000	
60E2 AHC	1:40	CA-252-000	R		S-SNEX 15-2462000	S-SNEX 15-2462000	S-SNEX 15-2462000	S-SNEX 15-2462000	S-SNEX 15-000953	S-SNEX 15-000953	S-SNEX 15-000953	S-SNEX 15-2462000	S-SNEX 15-2462000	
60E2 AHC	1:40	CA-252-000	R		S-SNEX 15-2462000	S-SNEX 15-2462000	S-SNEX 15-2462000	S-SNEX 15-2462000	S-SNEX 15-000953	S-SNEX 15-000953	S-SNEX 15-000953	S-SNEX 15-2462000	S-SNEX 15-2462000	
60E2 AHC	1:40	CA-253-000	L		S-SNEX 15-2462000	S-SNEX 15-2462000	S-SNEX 15-2462000	S-SNEX 15-2462000	S-SNEX 15-000953	S-SNEX 15-000953	S-SNEX 15-000953	S-SNEX 15-2462000	S-SNEX 15-2462000	
54E1	1:40	CA-502-000	R		S-SNEX 15-2462000	S-SNEX 15-2462000	S-SNEX 15-2462000	S-SNEX 15-2462000	S-SNEX 15-000953	S-SNEX 15-000953	S-SNEX 15-000953	S-SNEX 15-2462000	S-SNEX 15-2462000	
54E1	1:40	CA-503-000	L		S-SNEX 15-2462000	S-SNEX 15-2462000	S-SNEX 15-2462000	S-SNEX 15-2462000	S-SNEX 15-000953	S-SNEX 15-000953	S-SNEX 15-000953	S-SNEX 15-2462000	S-SNEX 15-2462000	
54E5	1:40	CA-491-000	R		S-SNEX 15-2462000	S-SNEX 15-2462000	S-SNEX 15-2462000	S-SNEX 15-2462000	S-SNEX 15-000953	S-SNEX 15-000953	S-SNEX 15-000953	S-SNEX 15-2462000	S-SNEX 15-2462000	
54E5	1:40	CA-492-000	L		S-SNEX 15-2462000	S-SNEX 15-2462000	S-SNEX 15-2462000	S-SNEX 15-2462000	S-SNEX 15-000953	S-SNEX 15-000953	S-SNEX 15-000953	S-SNEX 15-2462000	S-SNEX 15-2462000	
46E3	1:40	CA-502-000	R		S-SNEX 15-2462000	S-SNEX 15-2462000	S-SNEX 15-2462000	S-SNEX 15-2462000	S-SNEX 15-000953	S-SNEX 15-000953	S-SNEX 15-000953	S-SNEX 15-2462000	S-SNEX 15-2462000	
46E3	1:40	CA-503-000	L		S-SNEX 15-2462000	S-SNEX 15-2462000	S-SNEX 15-2462000	S-SNEX 15-2462000	S-SNEX 15-000953	S-SNEX 15-000953	S-SNEX 15-000953	S-SNEX 15-2462000	S-SNEX 15-2462000	
60 TB2344	1:40	CA-431-000	R		S-SNEX 15-2462000	S-SNEX 15-2462000	S-SNEX 15-2462000	S-SNEX 15-2462000	S-SNEX 15-000953	S-SNEX 15-000953	S-SNEX 15-000953	S-SNEX 15-2462000	S-SNEX 15-2462000	
60 TB2344	1:40	CA-432-000	L		S-SNEX 15-2462000	S-SNEX 15-2462000	S-SNEX 15-2462000	S-SNEX 15-2462000	S-SNEX 15-000953	S-SNEX 15-000953	S-SNEX 15-000953	S-SNEX 15-2462000	S-SNEX 15-2462000	

CARTRIDGE POCKET NUMBERING

Left-hand cartridge

Valid for cartridges:
CA-253-000, CA-492-000,
CA-503-000



Valid for cartridge:
CA-439-000



Valid for cartridge:
CA-432-000

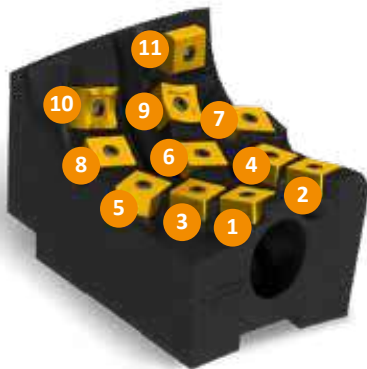

Right-hand cartridge

Valid for cartridges:
CA-252-000,
CA-491-000,
CA-502-000



Valid for cartridge:
CA-438-000



Valid for cartridge:
CA-431-000

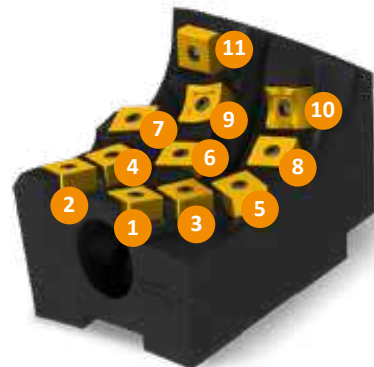

Valid for cartridge:
CA-526-000





DYNAMIC RAIL MILLING CUTTERS & INSERTS

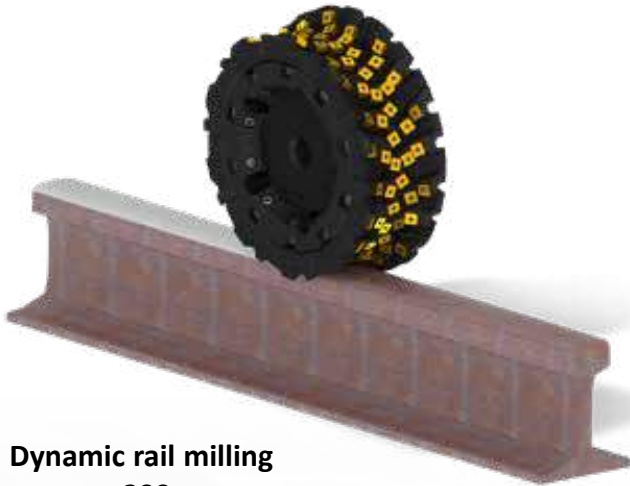

Dynamic rail milling cutter \varnothing 290 mm

Milling cutter for machining of the rail profile 60E1, 1:20 contains 10 easily interchangeable cartridges clamped by 3 screws, each containing 11 indexable inserts.



Dynamic rail milling cutter \varnothing 600 mm

Milling cutter for machining of rails that consist of universal basic body and 22 easily interchangeable cartridges clamped by 3 screws, each containing 11 indexable inserts. That is 242 inserts altogether. Cutting profile is defined by the used cartridges. Cartridges available for rail profiles 60E1, 60E2, 54E5, 54E1, 46E3 and others upon request. Milling cutter is suitable for Linsinger milling machines.



Dynamic rail milling cutter \varnothing 900 mm

Milling cutter for machining of rails that consist of universal basic body and 34 easily interchangeable cartridges clamped by one screw, each containing 11 indexable inserts. That is 374 inserts altogether. Cutting profile is defined by the used cartridges. Available cartridge for rail profile 60 TBT and others upon request.



Tangential indexable inserts

Inserts with higher thickness and IC for better rigidity. Usage of PVD grades (7310 and M8310) also increase reliability. Flat inserts (S-SNEX 15-2462000) that are used in all pockets (11) in cartridge doing roughing operation and in 9 out of 11 pockets in each cartridge doing the finishing operation are having 8 cutting edges while inserts with radiuses (insert type depends on the machined rail profile) that are used just for finishing operation in pockets 9 and 10 are having 4 cutting edges.



TURNOUTS MACHINING



TURNOUT ASSEMBLY

Turnouts are mechanical installations enabling railway trains to be guided from one track (A) to another (B or C) see picture. A switch generally has a straight "through" track (such as the main-line) and a diverging route. A straight track is not always present, for example, both tracks may curve, one to the left and one to the right.



- A – Crossing (frog)
- B – Stock rail
- C – Lead (closure) rails
- D – Tongue (Switch) rail
- E – Guard (check) rails
- F – Outside (running) rails
- G – Base (sole) plates
- H – Fish plate
- I – Stopper
- J – Stretcher bar
- K – Slide chair
- L – Connecting plate
- M – Switch motor
- N – Rail brace
- O – Washer
- P – Sleeper
- Q – Drive (switch) rod
- R – Heel (distance) blocks

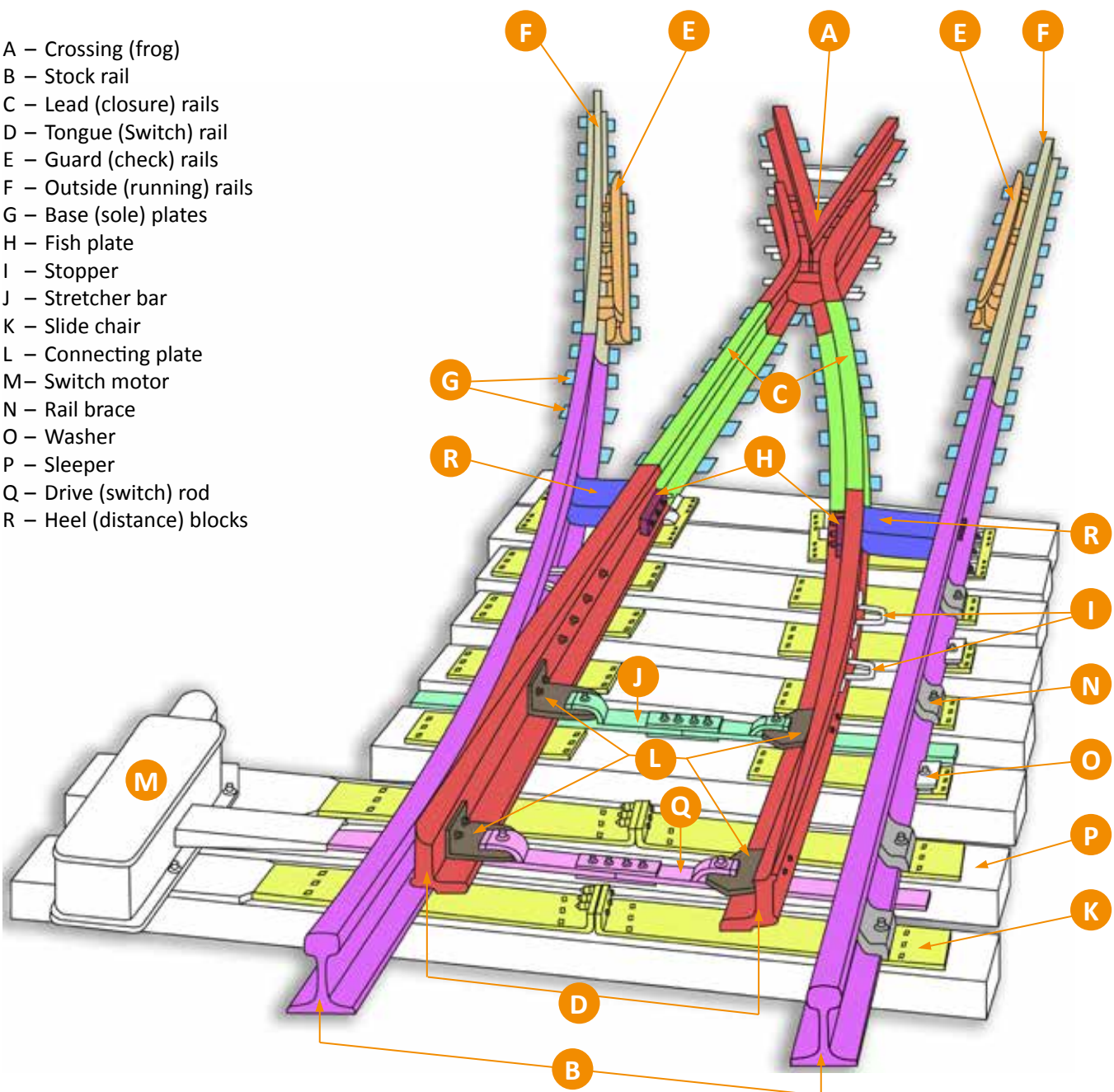

Crossing (frog) (A) – It is an arrangement of rails introduced at the junction where two rails cross to permit the wheel flange of the train to pass from one track to another.

Nose – is a most stressed part of the crossing. The wheel is in the air for just a short moment when it leaves the toe of the crossing and then it hit the nose. It happens everytime the train goes through the crossing.

Wing rail – rails which are used to guide the inner wheel flange of the train.

Guard (check) rails (E) – they are the rails which are used to guide the outer wheel flange of the train. They ensure that the train does not derail.

Crossings can be Mono-block (casted) or can be produced as an assembly (bolted or welded). There is a lot of machining operations on both types. Used tools and cutting conditions differs also because of different workpiece materials.

Manganese steel crossing:

Most crossings are produced from manganese steels (so called “Hadfield steel”)

- Manganese content 12 – 14 %.
- Very high wear resistant and tough material with hardness 200 – 280HB (before heat treatment)
- Material examples X120Mn12 / 1.3401 / 17 618.4
- Material is getting harder during machining process

Bainite crossings:

- Low carbon content $\leq 0.4\%$
- Very high wear resistance, 49 HRC, tensile strength 1.400 – 1.600 MPa
- Weldable
- Material examples Bainite 1400, Bainite 1400 plus, Bainite 1100, Bainite 1000

Machining process

Because most of the crossings or its parts are casted, there are a lot of machining operations. A rough workpiece is milled by special profile milling cutters to its final shape. Crossings from both materials are difficult to machine due to each materials’ characteristics. This is valid especially for manganese steel crossings where the material is getting harder after machining. Therefore, usually just one pass is used. Stock allowance is not equal, so the radial and axial depth of cut is changing. Tangential inserts made of tough grade (e.g., M8345 and M8346) with strong cutting edge together with big cutters in terms of diameter as well as in cutting length is highly recommended to be used to provide the needed productivity and reliability of the machining process.

The grade M8345 (M8346) is the first choice for these applications. This grade has exceptional operational reliability and is designed for heavy cuts in unfavorable conditions in difficult and tough materials.

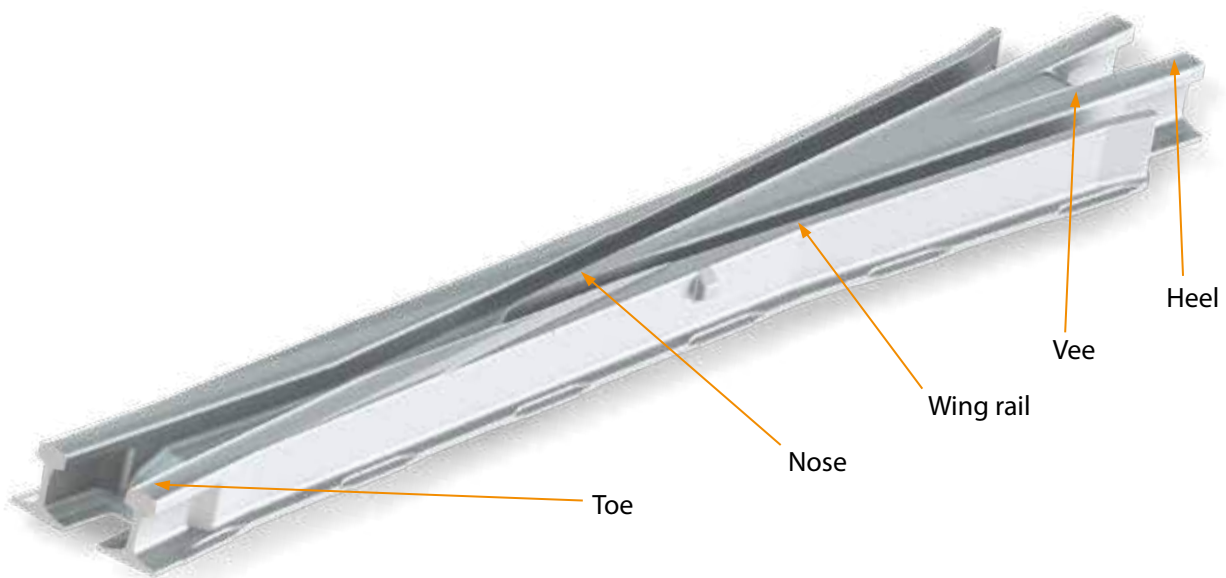



TONGUE RAILS

Tongue (switch) rail (D) - It is the moving part of the switch which diverts the train from one track to the other. Tongue rails lie between the two stock rails in the turnout assembly. Top and side of the tongue rail is tapered in such a way that they do not bear any load.

Stock rail (B) – They are the main rails of the track to which the tongue rails are fit closely. They are the outer rail in the turnout.

Heel (distance) blocks (R) – These are the blocks inserted between the heel of the stock rail and the tongue rail. It provides a clear gap for the wheel flange.

Slide chairs (K) – These are the special plates that provided for supporting and sliding the toe of the tongue rail. It helps the tongue rail to move toward and away from stock rails and tongue rails are able to slide.

Lead (closure) rails (C) – One side of the lead rail is connected to the heel of the tongue rail whereas the second side is connected to the toe of the crossing.

Stretcher bars (J) – Used to connect the toe of the tongue rails so that both tongue rails move through the same distance.

Tongue rails belong to the parts of the turnout assembly that need to be machined to the specific shape. Tongues are made of the same materials as standard stock rails (R260, R350HT,... see full table in the technical section). Gantry machines with long tables are usually used for such a machining. Tongues are fixed by clamps or by magnetic clamping to the table.

Dormer Pramet offers various milling cutters for machining of lots of different tongue rail profiles. Tapered cutters for machining the stock rail side of the tongue, tapered cutters with radius for machining of the wheel side as well as cutters for machining of the tongue rail head part are the most common tools.

Grade M9325 is a first choice for milling inserts. This grade has an ideal balance between wear resistance and toughness, it is mainly designed for roughing operations. Advantages are excellent wear resistance even at relatively high cutting speeds with excellent reliability. The grade is more suitable for applications using higher speeds and lower feed rates. The second choice is grade M8346 because of its exceptional operational reliability and suitability for heavy cuts in unfavorable conditions.

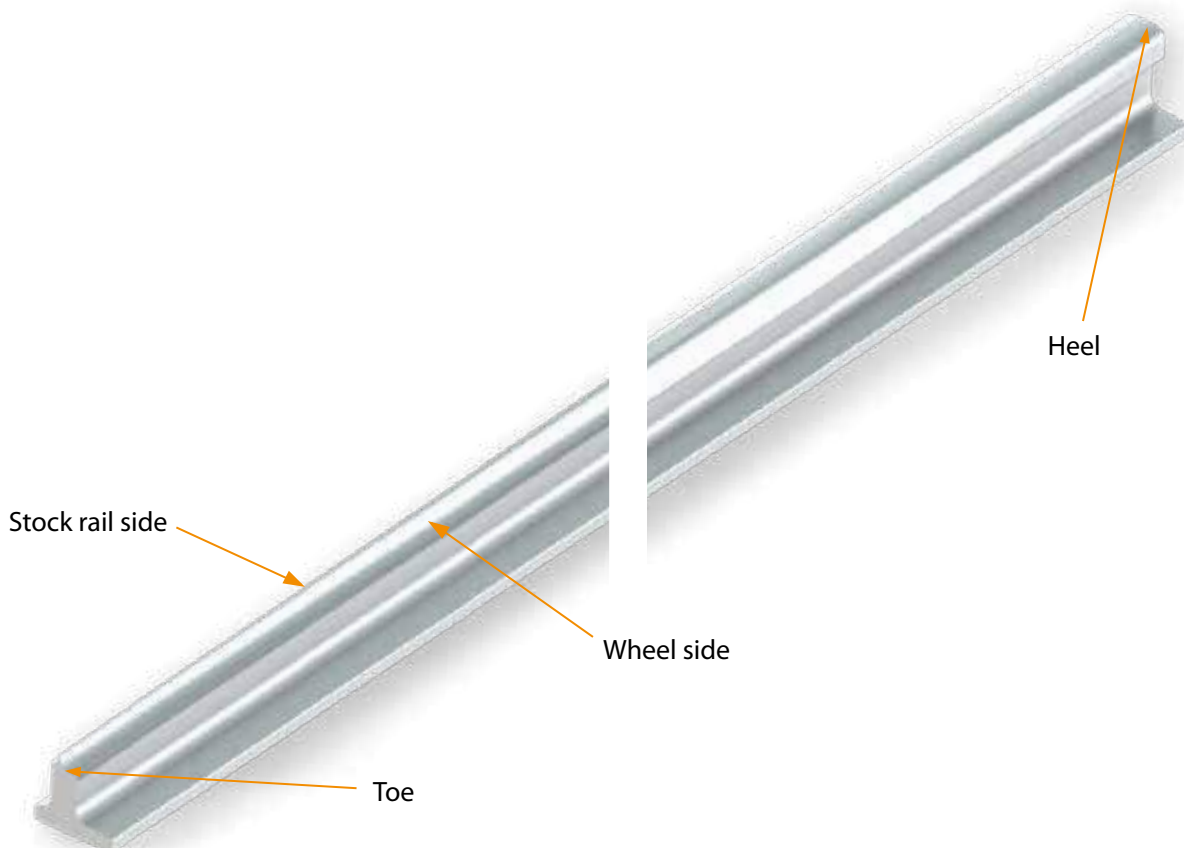



CROSSING – MACHINING OF BOTTOM SURFACE

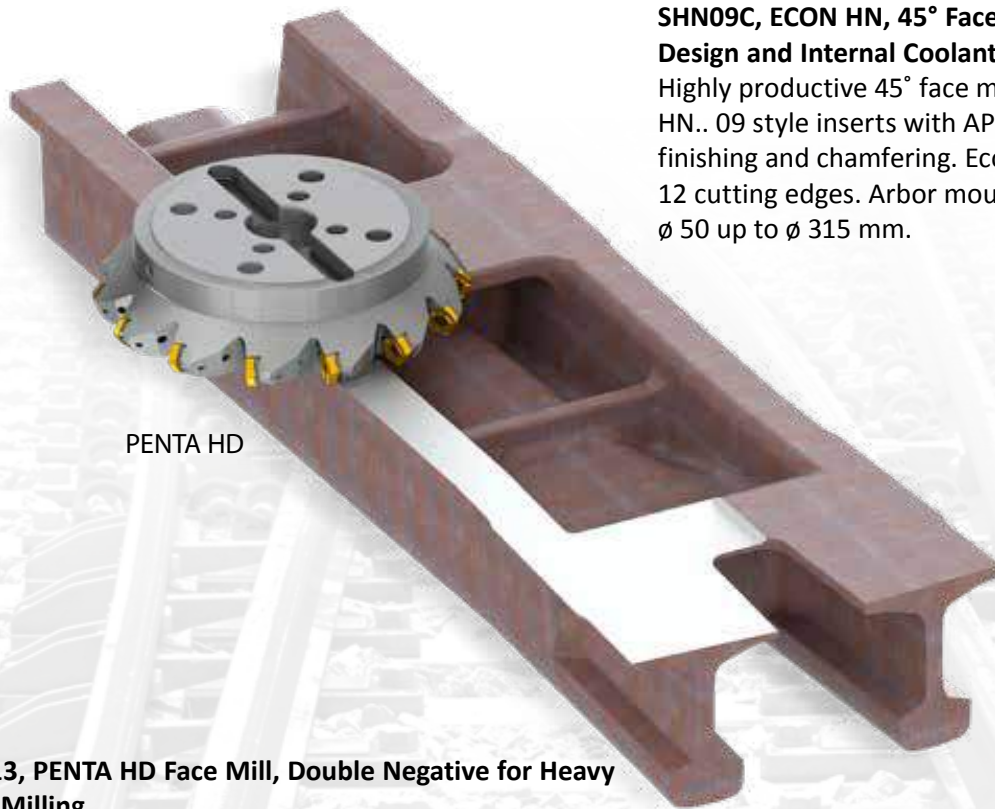

PENTA HD

SHN09C, ECON HN, 45° Face Mill with Double Negative Design and Internal Coolant

Highly productive 45° face mill utilising double sided HN.. 09 style inserts with APMX of 5 mm. Roughing, finishing and chamfering. Economical insert with 12 cutting edges. Arbor mounting only, in range from \varnothing 50 up to \varnothing 315 mm.



ECON HN

SPN13, PENTA HD Face Mill, Double Negative for Heavy Face Milling

High productive 57° face mill for double sided PN.. 13 and XN.. 13 style inserts with max. cutting depth APMX of 10 mm. Suited for face milling. Arbor mounting only, in range from \varnothing 100 up to \varnothing 315 mm. Insert seat protected with shim. Easy insert exchange.



Special \varnothing 250 mm cutters

1 – High productive 43° face milling cutter with 16 cartridges to protect the body. Double sided negative inserts with max. cutting depth APMX of 15 mm.

2 – Face milling cutter for heavy milling applications with positive RCMT 20 inserts and APMX of 10 mm. Additional clamp for proper insert clamping. Insert seat protected with shim.

3 – 75° face milling cutter with smaller tangential double-sided inserts with 8 cutting edges and max. cutting depth APMX of 5 mm.





CROSSING – MACHINING OF BOTTOM ENDS AND COPY MILLING



SRC16, 20

SRC16 and SRC20, Profile or Copy Milling Cutter for Round Inserts Size 16 and 20

Milling cutter for medium to heavy profile and copy milling with positive RCMT 16 inserts and APMX of 8 mm and RCMT 20 inserts and APMX of 10 mm. Suitable for face, helical interpolated, ramping, progressive plunge, and high feed milling. SRC16 available in arbor mounting only and coolant through, in range \varnothing 63 up to \varnothing 160 mm. SRC20 available in arbor mounting only and coolant through, in range \varnothing 80 up to \varnothing 160 mm.



SRD12 and SRD16, Copy Milling Cutter for Round Inserts Size 12 and 16 with Coolant Through

Milling cutter for profile and copy milling with positive RD.. 12 and 16 inserts and APMX of 3 mm and 4 mm. Suitable for face, helical interpolated, ramping, progressive plunge, copy, and profile milling. SRD12 available in modular and arbor mounting, in range \varnothing 24 up to \varnothing 80 mm. SRD16 available in modular and arbor mounting, in range \varnothing 32 up to \varnothing 100 mm.

K3-CXP



L2-SZP



L2-SZP, Ballnose Profile Milling Cutter for ZP.. Style Inserts

Ballnose milling cutter for ZP.. style inserts with APMX from 8.9 up to 44.7 mm. Suitable for copy, and profile milling. Available in cylindrical, weldon, morse taper and modular mounting, in range \varnothing 10 up to \varnothing 50 mm.

K3-CXP, MULTISIDE XP Profile Milling Cutter for XP.. Style Inserts

Ballnose milling cutter for XP.. style inserts with APMX from 8 up to 16 mm. Suitable for productive copy, and profile milling by 3 inserts for higher productivity. Available in cylindrical and modular mounting, in range \varnothing 16 up to \varnothing 32 mm.



SRD12, 16





1 – Corner rounding arbor style cutter
 ø 100 mm with 5 effective teeth for machining of outer radii. Positive tangential inserts with 4 cutting edges with various radius sizes.

2 – Corner rounding shank style cutter
 Shank style (weldon) cutter with the smallest ø 7 mm available with several different radii for machining in hard-to-reach places. Two effective teeth with usage of just one insert.

3 – Corner radius cutter
 Shank style (weldon) cutter for machining of fillet radii together with an inclined wall. Cutter can be used in narrow grooves due to its small diameter ø 16 mm. Two effective teeth with usage of just one insert.

4 – Corner rounding cutter
 Shank style (weldon) cutter ø 40 mm with 3 effective teeth for machining of outer radii. Positive tangential inserts with 4 cutting edges with various radius sizes.





CROSSING – MACHINING OF HEAD

1

1 – Robust disc milling cutter for face milling
ø 320 mm with a lightweight modification for machining of flat surface of the crossing. Smooth cutting process with tangential inserts with 8 cutting edges.

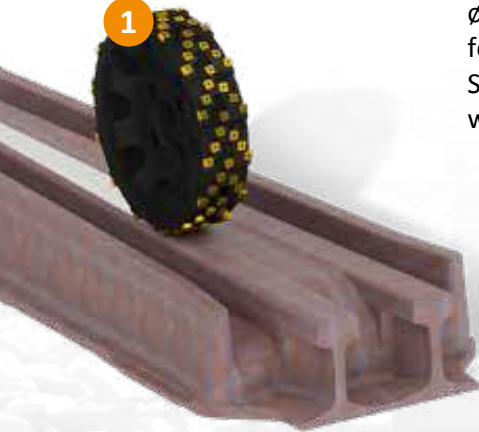

2

2 – Concave style milling cutter for machining of the wing rails
maximum ø 340 mm with very wide cutting area for milling of corner radius (R13), top radii (R80, R300) and two inclined faces (1:20, 1:10).



3 – Pot-shaped milling cutter for machining of the top of the toes
ø 330 mm for machining of top radii (R13, R80, R300), flat and inclined (1:8) surfaces. Thick tangential inserts with 8 cutting edges suitable for heavy cutting conditions.



4 – Disc milling cutter for machining of the top of the rail head
ø 350 mm, machining of corner radius (R13) and the side of the head in the groove. Protective inserts in the biggest cutter diameter in case of extra material removal need.



5 – Milling cutter for machining of the top of the toes
ø 200 mm with corner radius R1.2 mm for machining of inclined surface (1:20) and 90° wall.



1 – Disc milling cutter for groove machining
 ø 420 mm cutter, for machining of the groove walls (1:20, 1:5) and bottom radius (R15).
 Productive solution due to the strong body design with 8 effective teeth and tangential inserts usage.



2 – Disc milling cutter for machining of the groove wall
 ø 250 mm cutter with 6 effective teeth for machining of the side of the groove with a short relief radius. Rigid tangential inserts with 8 cutting edges, respectively 2 cutting edges (radius inserts) ensure the cutting process reliability.



3 – Disc milling cutter for 90° wall machining
 ø 420 mm cutter for machining of the 90° wall and the bottom radius (R10) in the groove. 10 effective teeth, 30 tangential radius inserts with two cutting edges each.

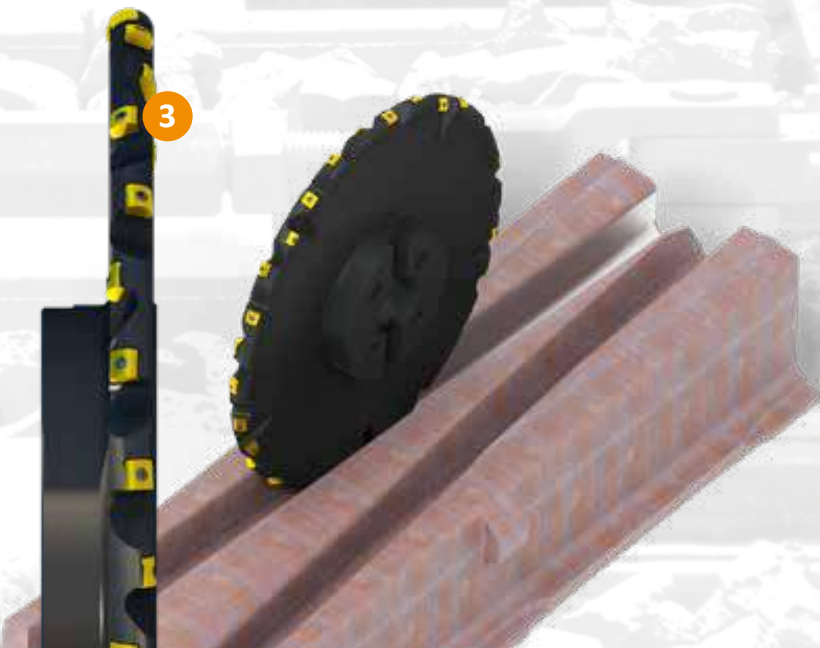

4 – Shank style milling cutter for machining of grooves
 ø 22 mm cutter with positive cutting inserts for machining of the radius R13 and tapered wall.



CROSSING – MACHINING HEEL AND TOE

J(T)-SLSN, ROUGH SN, Long edge Endmill for Heavy Milling with Coolant Through

90° long edge end mill with LNET 16 and SN.. 13 inserts and APMX of 104 up to 134 mm. Body with main shaft and separable headpiece. Suited for shoulder, slot, face or plunge milling. Available in DIN 69871, BT and DIN 2080 50 taper mounting, in \varnothing 63 and \varnothing 80 mm.

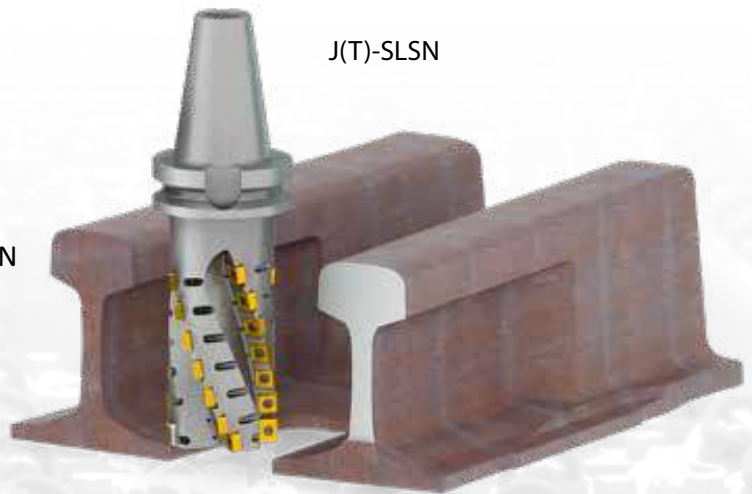

J(T)-SLSN

J(T)-SAD16E

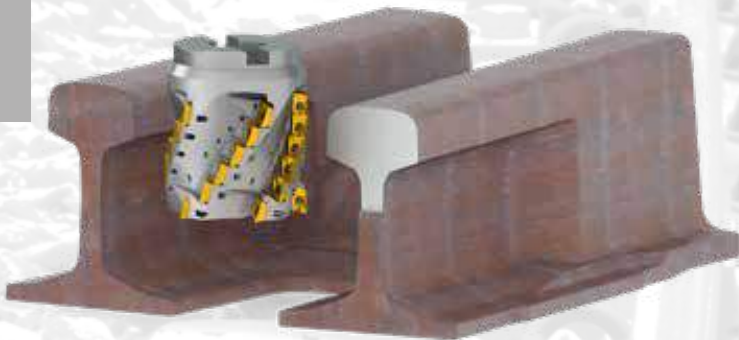

J(T)-SAD16E, HELICAL AD, Long Edge End Mill for AD.. Insert for Medium Milling

90° long edge end mill for positive AD.. 16 inserts with APMX of 40 up to 108 mm with coolant through. Suited for shoulder, slot, face or plunge milling. Available in arbor, ISO, BT and 2080 taper mounting, in \varnothing 50 up to \varnothing 100 mm. Available with differential tooth setting.

Special Long Edge Endmill for heavy Milling with separable headpiece

90° long edge end mill for rigid negative inserts with APMX of 77 up to 100 mm with coolant through. Suited for shoulder and face milling. Available in arbor mounting, in \varnothing 80 and \varnothing 100 mm in right and left hand version. Replaceable headpiece with tangential inserts with corner radius, main body with tangential inserts with 8 cutting edges.





1 – Multifunctional milling cutter

with tangential inserts that can be used for machining of the inclined top surface of the crossing, or it can be used for the machining of the slots for the braces (clamps) and their side.

2 – 75° face milling cutter

for machining of the top surface of the Vee and the nose where fine surface is needed. Tangential insert with corner radius and 8 cutting edges is used on the periphery as well as in the bottom as a wiper insert.



3 – Back face disc milling cutter

∅ 290 mm with tangential CNHQ 1005AZTN inserts suitable for machining of the bottom of the crossings and tongue rails.

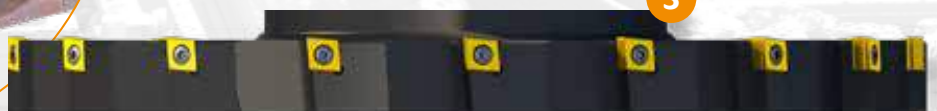
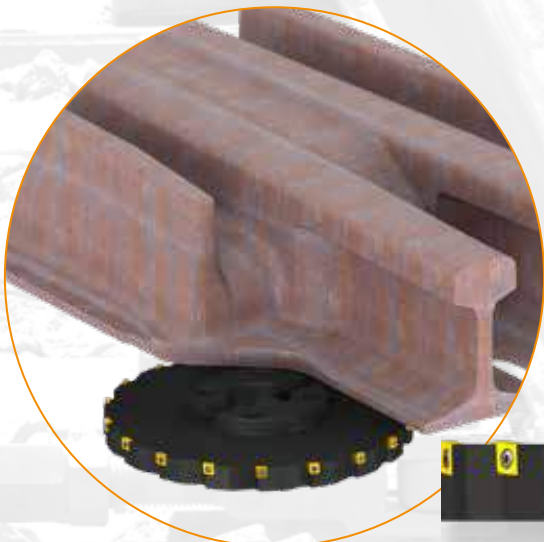



CROSSING/TONGUE RAIL – MACHINING OF WEB

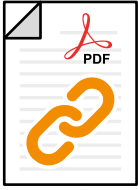

ECON LN Square Shoulder End Mill for LN.. Insert with Coolant Through

90° end, or shell mill for double sided LN.. 12 inserts with APMX of 9 mm. Suited for wide range of applications. Available in cylindrical, weldon, modular and arbor mounting, in \varnothing 25 up to \varnothing 125 mm. Available with differential tooth pitch.



Special full profile milling cutter for web machining – one cutter/one pass

Rigid tangential inserts with 4 and 8 cutting edges. Cutter makes full profile in one pass. Suitable for strong and rigid machines.



Special half profile milling cutter for web machining – two cutters/two passes

Solid body cutter with ISO cone back-end. Rigid tangential inserts with 4 and 8 cutting edges. Cutter makes half profile.

Special profile milling cutter for web machining – one cutter/two passes

Rigid tangential inserts with 4 and 8 cutting edges. Cutter makes the profile in two passes therefore there are lower cutting forces and low vibrations.



TONGUE RAIL – MACHINING OF HEAD AND HOLEMAKING

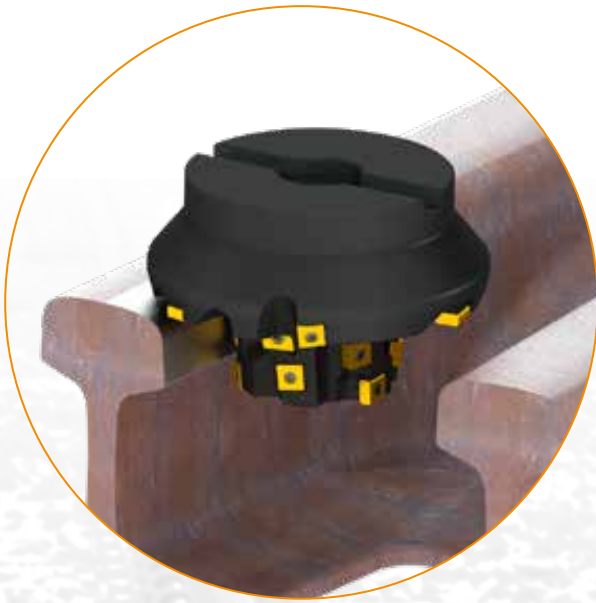

Special profile milling cutter for machining of the rail head
 Right and left-handed milling cutters for various rail profiles and its inclinations. Suitable for machining of the top of the rail head, corner radius and tapered wall on toes and heels of crossings and tongue rails. Tangential inserts increase reliability of the machining process.



HYDRA: High performance replaceable head drills
 Interchangeable solid carbide head drills for high performance machining of steels, stainless steels and cast iron. Fail-safe head location can be changed without ejecting the drill from the machine. Available with coolant feed and a choice of HSS bodies from 1.5xD for improved rigidity in shallow hole and plate drilling, through to 12xD for deeper hole applications. Available in \varnothing 12.0 – \varnothing 42.0 mm.

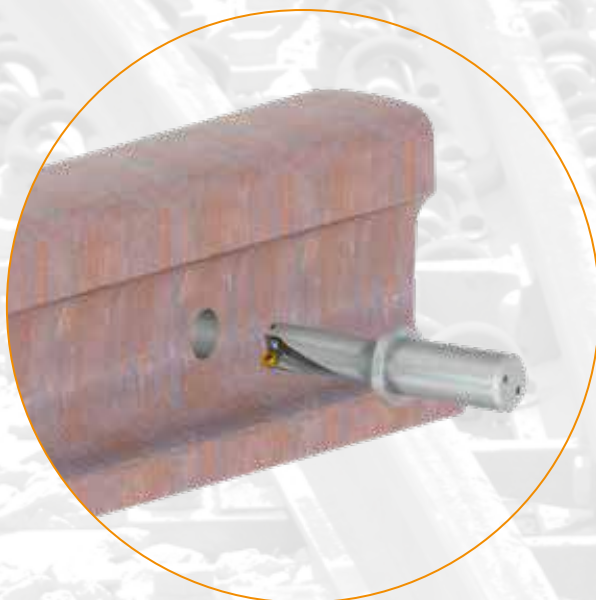

Indexable Insert Drill with Internal Coolant Feed
 High performance indexable insert drill for drilling blind and trough holes and potentially cross-, off center-, helical and stacked material drilling, plunging, drilling on concave or sloped surfaces, drilling with interrupted cuts, chamfer drilling and even boring type drilling. Available from \varnothing 15 up to \varnothing 40 mm in 2xD, from \varnothing 15 up to \varnothing 58 mm in 3xD, from \varnothing 17 up to \varnothing 58 mm in 4xD and from \varnothing 19 up to \varnothing 31 mm in 5xD.

TONGUE RAIL – MACHINING OF TAPERS

Double sided tapered milling cutter

Special milling cutter in various diameters that can be held from both sides to allow machining of standard and inverted tapers with the same cutter body. Usage of rigid tangential inserts with 8 cutting edges makes the cutting process productive and reliable.



Double tapered milling cutter for tongue rails machining

Special milling cutter for machining of two connected tapers used for machining of faces on tongue rails that will be matched with mirrored faces on the stock rail. Tangential inserts with 8 cutting edges are used.

Tapered milling cutter for machining of tongue rails

Special milling cutter with $\varnothing 100$ for machining of inverted tapers on smaller machine tools. 8 cutting edges on each tangential insert make the process more economical.



TONGUE RAIL – MACHINING OF WHEEL SIDE

Profile milling cutter for machining of tongue rails

Milling cutters for various rail profiles with minimum \varnothing 150 mm and maximum \varnothing 300 mm. Machining of the wheel side of the tongue rail. Tapered face, top corner radius and the top tongue rail surface. Cutter equipped with large tangential inserts on the largest diameter for higher depth of cuts.



Profile milling cutter for machining of top radius and tapered face

\varnothing 200 mm profile cutter for machining of tongue rails. Tangential inserts with 8 cutting edges, resp. 4 cutting edges on radius inserts and on protective inserts on the top and the bottom.

Profile milling cutter for machining of tongue rails

Milling cutters for various rail profiles with minimum \varnothing 110 mm and maximum \varnothing 300 mm. Machining of the wheel side of the tongue rail. Bottom radius, tapered face, top corner radius and the top tongue rail surface. Cutter equipped with tangential inserts for high reliability.

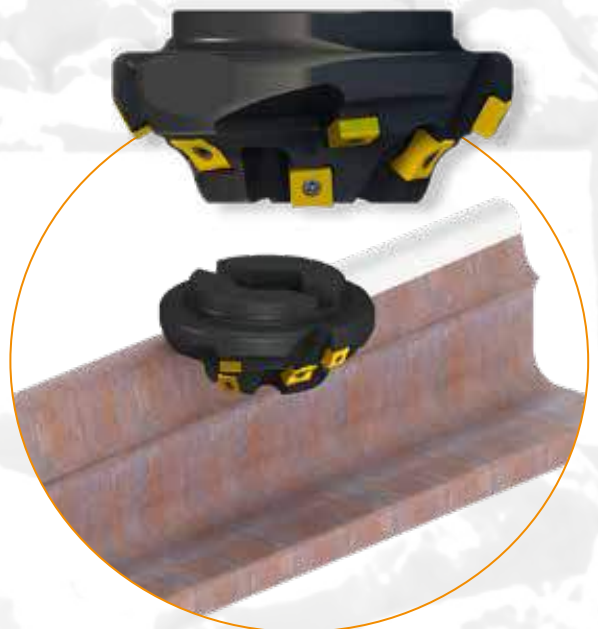
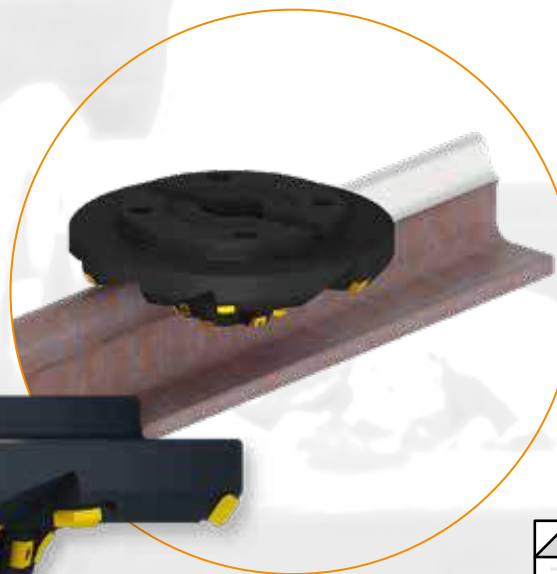

Cutter for machining of radius R13 and tapered faces from both sides

Small milling cutter with min. \varnothing 70 mm for machining of radius R13 and tapered surface 1:3. Double sided, 4 cutting edges radius inserts and 8 cutting edges double sided square inserts for high material removal rate.





TONGUE RAIL – MACHINING OF WHEEL SIDE



Tapered, arbor style milling cutters for machining of running side of tongue rails

Special right and left-handed milling cutters in wide range of diameters (\varnothing 80 – 200 mm), various setting angles KAPR (1:3, 1:4, 1:5,...), radius sizes (R13, R14, R20...) and cutting depths.

Square shaped rigid tangential inserts with 8 cutting edges, 4 or 2 cutting edges on radius inserts that ensures high material removal rate.

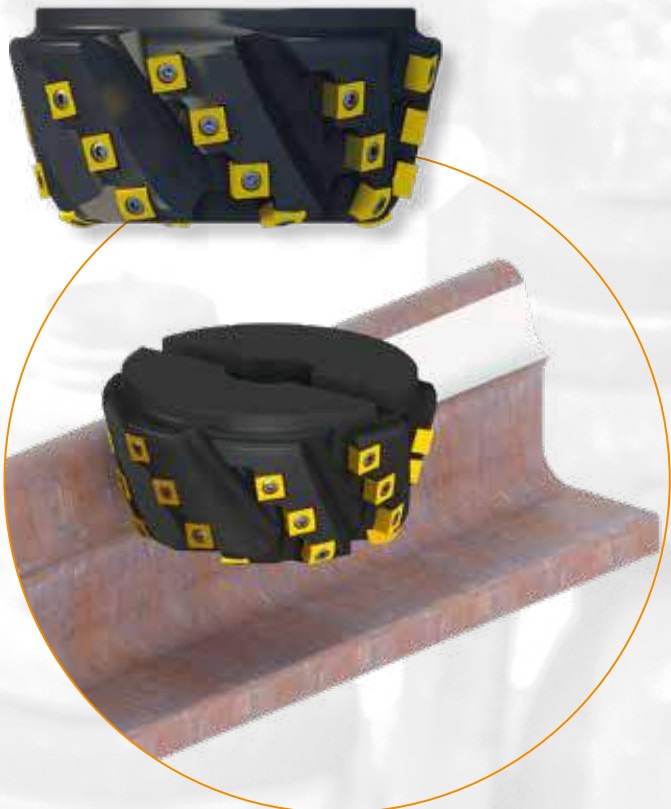

2516, 45° Chamfer Milling Cutter with Triangular Insert and Coolant Through

45° Chamfer milling cutter with single sided TC..16 inserts and APMX 8.5 mm. Suited for top side chamfering. Available in weldon mounting only, in range of outside ϕ 31 and ϕ 39 mm.

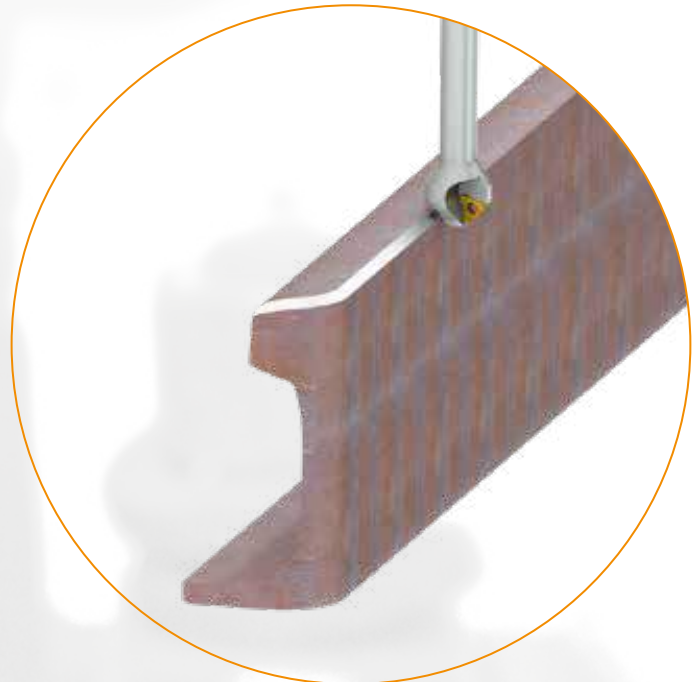
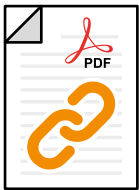

Special milling cutter for machining of 90° wall and the bottom chamfer

ϕ 160 mm cutter for machining of the bottom side of the tongue rail with a possibility of machining of the 45° chamfer on the bottom. Usage of rigid tangential inserts with 8 cutting edges makes the cutting process productive and reliable.



J(T)-SXP16, Long Edge Chamfer Milling Cutter with Coolant Through

Chamfer milling cutter with single sided XPHT 16 inserts and APMX between 7 up to 28 mm. Suited for top chamfering. Available in arbor mounting only. Outside ϕ 35 and ϕ 45 mm, in range of 15°, 25°, 30°, 35°, 40°, 45°, 50°, 55°, and 60° chamfer angle.

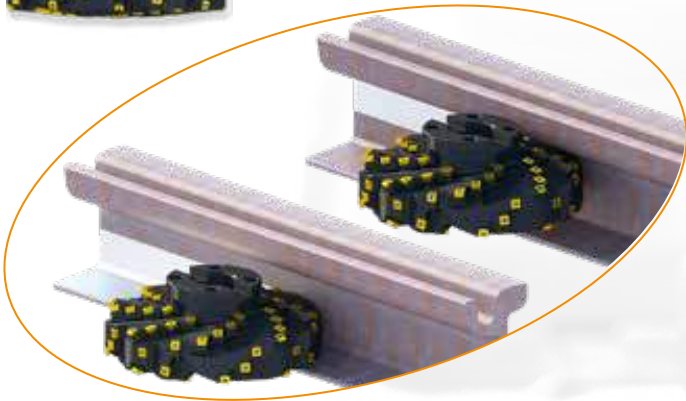

Special profile milling cutter for machining of the tram rail web in two steps

∅ 300 mm cutter for machining of the rail web, radii R10, fillet with taper 1:5 and the top of the base with taper 1:10. All is done in two steps. Milling cutter has 4 effective teeth by using square tangential inserts with 8 cutting edges and square tangential inserts with 2 cutting edges.



Special profile milling cutter for machining of the tram rail web and the side of the head in two steps

∅ 280 mm cutter for machining of the side of the rail head with taper 1:6, radius R35, rail web radii R10, fillet with taper 1:5 and the top of the base with taper 1:10. All is done in two steps. Milling cutter has 4 effective teeth by using square tangential inserts with 8 cutting edges and square tangential inserts with 2 or 4 cutting edges.

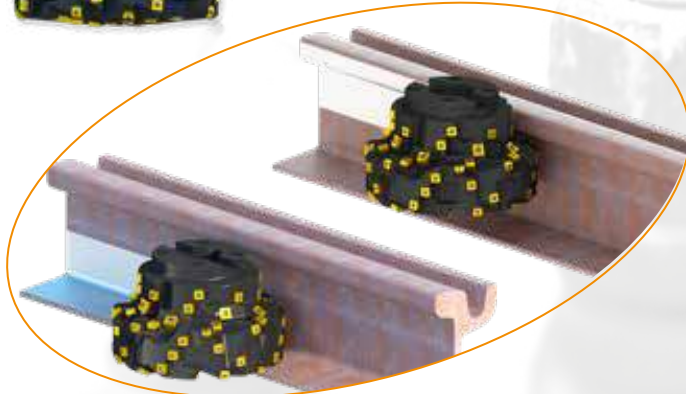

Special profile milling cutter for machining of the tram rail web in two steps

∅ 240 mm cutter for machining of the side of the rail head with 90° wall, radius R15, rail web radii R10, fillet with taper 1:5 and the top of the base with taper 1:10. All is done in two steps. Milling cutter has 4 effective teeth by using square tangential inserts with 8 cutting edges and square tangential inserts with 2 or 4 cutting edges.

Special profile milling cutter for machining of the side of the crossing's block

The cutter is assembled out of two pieces with the minimum \varnothing 90 mm and maximum \varnothing 165 mm. Milling cutter can be held from both sides that brings the possibility to use the cutter as the right-hand and left-hand version.



Special profile milling cutter for machining of the side and bottom of the crossing's block

Milling cutter with the maximum \varnothing 220 mm for machining of tapered sides of the crossing's block and for machining of the 90° wall in the bottom part. Square shaped rigid tangential inserts with 8 cutting edges and 4 cutting edges on radius inserts ensure high material removal rate.



Special tapered corner radius cutter for machining of the crossing's block groove

Shank style milling cutter for machining of the tapered groove sides (inclination 1:4) and fillet radius R10. Minimum cutter \varnothing 27.5 mm and APMX of 27 mm.

Special profile milling cutter for machining of the heel (distance) blocks

The cutter is assembled out of three parts with the minimum \varnothing 109 mm and maximum \varnothing 165 mm. Cutter is used for machining of the middle part (90°) and two tapered surfaces (1:3) on the heel block but it also has protective inserts in case of extra material in reliefs.

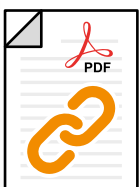



MACHINING OF SWITCH RODS

Special profile milling cutter for machining of switch rod

Profile milling cutter with maximum \varnothing 200 mm for machining of fillet radius R5 and outer radii R150 mm, respectively R200 mm. Cutter is equipped with rigid tangential inserts with 8 or 4 cutting edges that ensure high material removal rate.

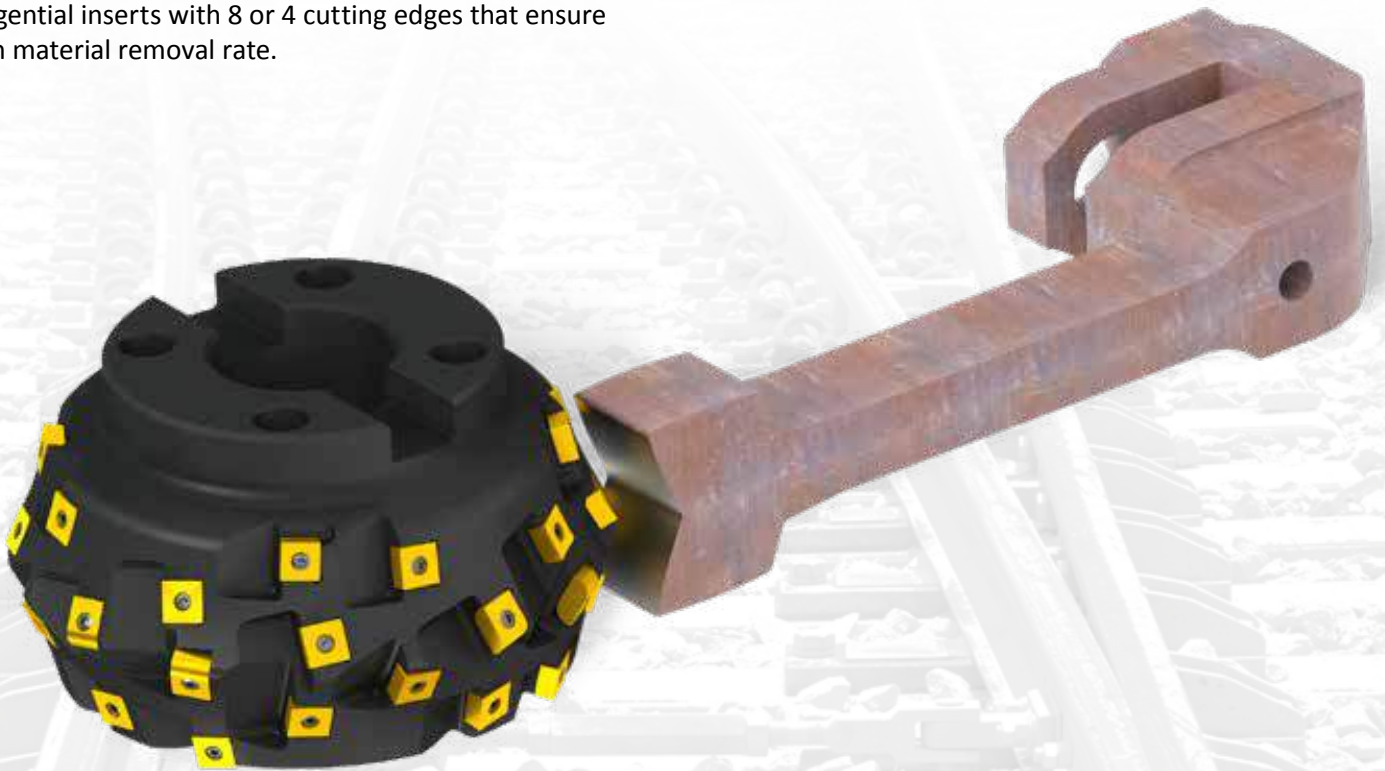

Special shank style milling cutter with inverted taper shape

Cutter \varnothing 49 mm with maximum APMX of 32 mm is equipped with strong tangential insert for machining of the corner radius R3 and with radial standard inserts with sharp geometry for a smooth cutting process. Cutter is machining an inverted tapered wall with a 70° (1:2.75) inclination.





BASE PLATES MACHINING



BASE PLATES

Base plates, also called sole plates or tie plates, are used to fix the rail to the sleeper. These plates increase bearing area and holds the rail to the correct gauge.

Base plates are fastened by the bolts or spikes to the sleeper. The rail is attached to the plate by a system of clips or clamps, depending on the design. To avoid the vibration and to reduce the noise the rubber pad is used between the rail and the base plate as well as between the base plate and the sleeper. The part of the plate under the rail can be flat but often it is tapered 1:X (1:20, 1:40, ...) so both the rails in the track are inclined to the track center.

The base plates are produced from the long rolled stripe with pre-rolled ribs. The cutting of the rolled stripe is then done by shearing or sawing. The holes are punched or drilled and the slot for T-head bolt is done by milling. Base plates are made of steel S275JR with a content of C 0.21 %, the tensile strength is 410 up to 560 Mpa.

Dormer Pramet offers a wide range of standard tools for face milling, slot machining and drilling operations and special tools that are need to be used for machining of the dove-tail groove for the T-head bolt.

Grades first choices for machining of base plates are M8326, M8340 in the milling area and D8330, D8345 for drilling applications.

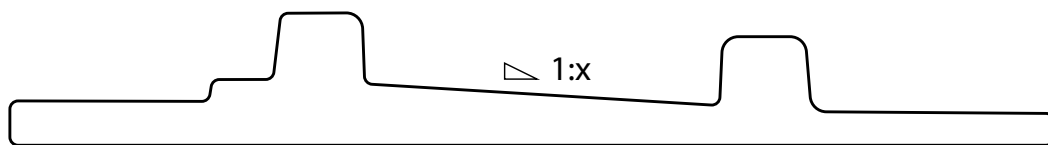



MACHINING OF BASE PLATES – BOTTOM PART

SPN13, PENTA HD Face Mill, Double Negative for Heavy Face Milling

High productive 57° face mill for double sided PN.. 13 and XN.. 13 style inserts with max. cutting depth APMX of 10 mm. Suited for face milling. Arbor mounting only, in range from \varnothing 100 up to \varnothing 315 mm. Insert seat protected with shim. Easy insert exchange.



SPN 13

SHN06C and SHN09C, ECON HN, 45° Face Mill with Double Negative Design and Internal Coolant

Highly productive 45° face mill utilising double sided HN.. 06 style inserts with APMX of 3 mm. Roughing, finishing and chamfering. Economical insert with 12 cutting edges. Differential tooth pitch. SHN06C: Weldon, screw and arbor mounting available, in range from \varnothing 25 up to \varnothing 125 mm. SHN09C: Arbor mounting only, in range from \varnothing 50 up to \varnothing 315 mm.

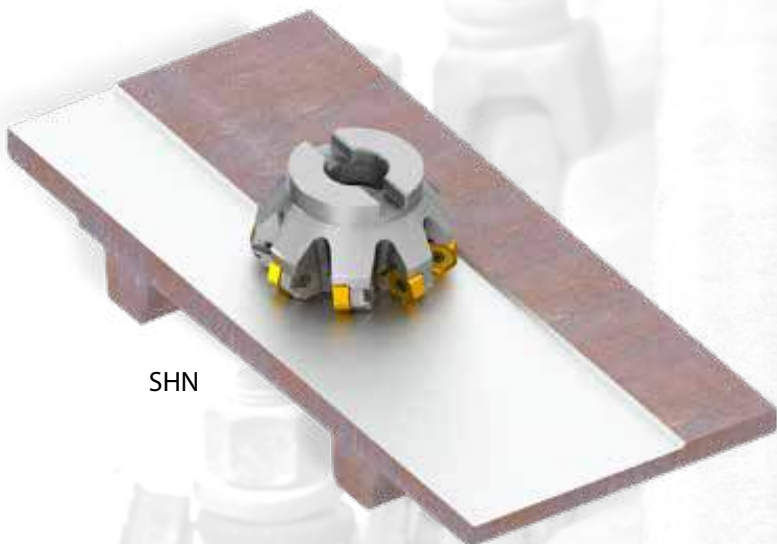

SHN

SRD12 and SRD16, Copy Milling Cutter for Round Inserts Size 12 and 16 with Coolant Through

Milling cutter for profile and copy milling with positive RD.. 12 and 16 inserts and APMX of 3 mm and 4 mm. Suitable for face, helical interpolated, ramping, progressive plunge, copy, and profile milling. SRD12 available in modular and arbor mounting, in range \varnothing 24 up to \varnothing 80 mm. SRD16 available in modular and arbor mounting, in range \varnothing 32 up to \varnothing 100 mm.



SRD12, 16



MACHINING OF BASE PLATES – ROUGHING OF THE GROOVE

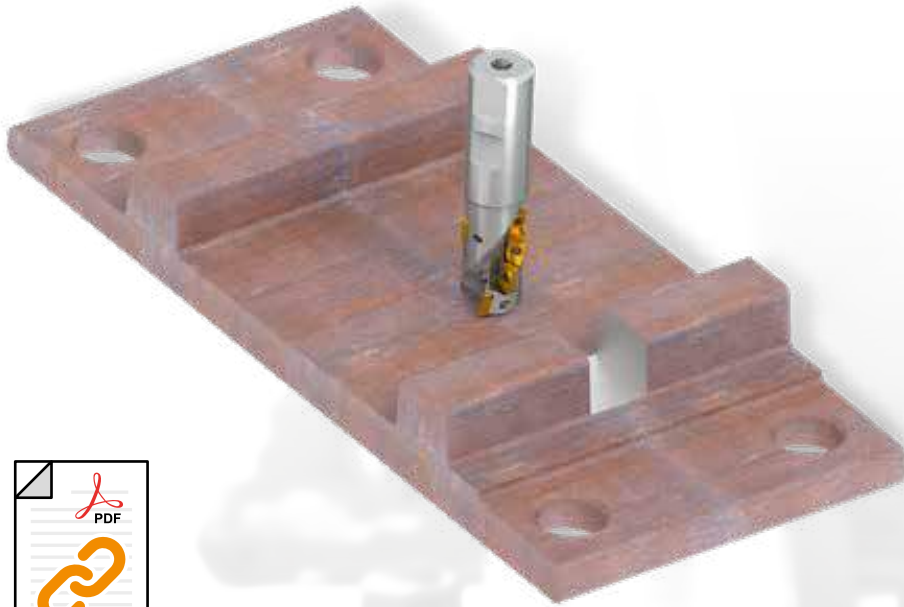

J(T)-SAD11E

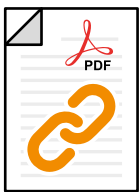

J(T)-SAD11E, FORCE AD Long Edge End Mill for ADMX Insert for Medium Milling

90° long edge end mill for positive ADMX 11 inserts with APMX of 37 up to 56 mm with coolant through. Suited for shoulder, slot, face, or plunge milling. Available in weldon, morse and arbor mounting only, in \varnothing 25 up to \varnothing 50 mm.

S90CN(XN), Side and Face Disk Milling Cutter with adjustable Cutter Width

90° side and face cutter for SNHX 12 inserts and APMX of 16 up to 50 mm depth and adjustable CW of 14 up to 30.5 mm cutter width. Suited for shoulder, slot, face, or face milling. Available in arbor or stub arbor mounting, in range \varnothing 125 up to \varnothing 315 mm.

S90SN, Side and Face Disk Milling Cutter

90° side and face cutter for SNHX 12 inserts and APMX of 16 up to 50 mm slotting depth and CW of 4 up to 14 slotting width. Suited for shoulder, slot, face, or face milling. Available in arbor or stub arbor mounting, in range \varnothing 63 up to \varnothing 200 mm.

S90CN(XN)



S90SN



MACHINING OF BASE PLATES – ROUGHING OF THE GROOVE



S710, 2-Flute Solid Carbide End Mill

Medium 2-flute design with 40° helix provides high rigidity for milling standard slots. AlCrN coating increases service life and improves performance. For plunging, ramping and profile milling. Available in range from \varnothing 1 up to \varnothing 20 mm with APMX from 3 mm up to 38 mm.

S812HA, 2-Flute Solid Carbide Slot End Mill, DIN 6536HA Shank

Medium length 2-flute design provides high rigidity for milling standard slots to a P9 tolerance. Alcrona coating increases service life and improves performance. For plunging, ramping and profile milling. Available in range from \varnothing 2 up to \varnothing 20 mm with APMX from 6 mm up to 32 mm.

S822, 2-Flute Solid Carbide Slot End Mill

Longer length 2-flute design provides high rigidity for milling standard slots to a P9 tolerance. Alcrona coating increases service life and improves performance. For plunging, ramping and profile milling. Available in range from \varnothing 2 up to \varnothing 20 mm with APMX from 8 mm up to 38 mm.

S922, 2-Flute Solid Carbide Slot Mill, DIN 6535HB Shank

Medium length 2-flute design provides high rigidity for milling standard slots to a H10 tolerance. A TiAlN coating for higher temperature resistance and longer tool life. For plunging, ramping and slot milling. Economical range of milling cutters with weldon shank. Available in range from \varnothing 2 up to \varnothing 20 mm with APMX from 6 mm up to 38 mm.

C135, 2-Flute HSS-E Long Reach Slot Drill / Milling Cutter, DIN 1835B Shank

Long reach 2-flute design provides high rigidity for milling standard keyway slots to a P9 tolerance. Provides increased strength and reduced vibration in difficult to reach areas. Can be used for plunging, ramping and profile milling. Available in range from \varnothing 2 up to \varnothing 20 mm with APMX from 7 mm up to 38 mm.



MACHINING OF BASE PLATES – DOVE-TAIL GROOVE

C825, HSS-E Side and Face Cutter / Milling Cutter, Weldon Shank

Versatile side and face cutters for grooving and slot milling. The Weldon shank provides accurate and stable holding whilst the side and face milling head makes the tools good for creating slots in vertical walls. Bright finish. Available in range from \varnothing 40 up to \varnothing 63 mm with APMX from 3 mm up to 16 mm.

1 – Special T-slot milling cutter with positive inserts

Shank style milling cutter \varnothing 42 mm for machining of the T-slot with APMX of 10 mm. Standard positive SOMT 09T3 inserts for smooth cutting process.



C825

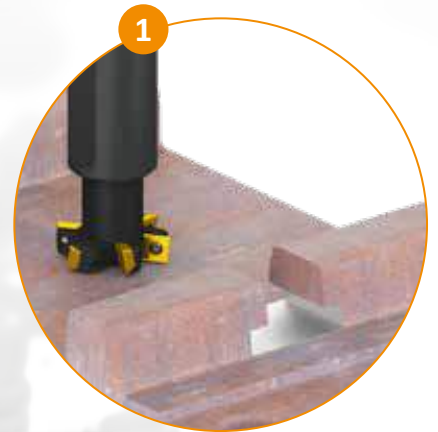

1



4



2 – Roughing dove tail cutter

Shank style milling cutter \varnothing 45 mm for roughing of the dove tail shape groove. Usage of standard positive SOMT 09T3 and special tangential LDEX 12 inserts.

3 – Left-handed finishing dove tail cutter

Shank style milling cutter \varnothing 57 mm that makes the full shape of the groove together with 90° wall on the groove sides.

4 – Left-handed finishing dove tail cutter

Shank style milling cutter \varnothing 57 mm that makes the full shape of the groove together with 90° wall on the groove sides and chamfer on the top edges.

5 – Special step-drills

Step drills with various diameters for drilling of the mounting holes in base plates. Drill can do the machining of the chamfer on the top as well as on the bottom by circular interpolation.



2



3



5

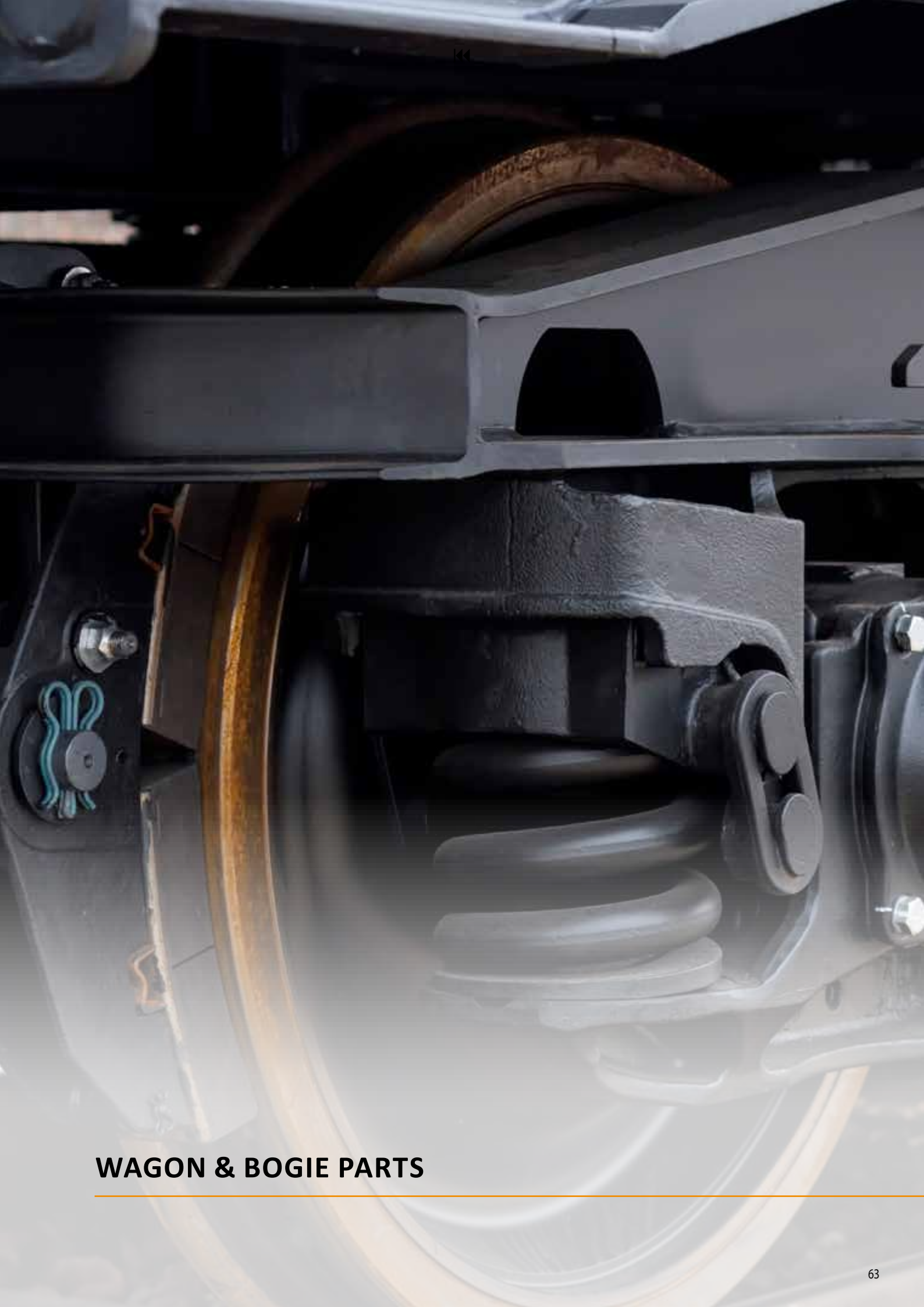

WAGON & BOGIE PARTS



WAGON PARTS

Round tools for drilling, tapping and deburring operations on various wagon parts such as wagon frames and bogies. You can find a high variety of different geometries and grades of our tools for different kind of work-piece materials and applications.

Hydra

Interchangeable solid carbide head drills for high performance machining of steels, stainless steels and cast iron. Fail-safe head location can be changed without ejecting the drill from the machine. Available with coolant feed and a choice of HSS bodies from 1.5xD for improved rigidity in shallow hole and plate drilling, through to 12xD for deeper hole applications.



Force drills – X, M, N

FORCE X carbide drills are developed for high performance machining applications in a wide variety of work-materials such as Carbon and Alloy Steels up to 1500 MPa and Cast-Iron. FORCE X drills also perform well in Stainless Steel and Aluminum making them an ideal first choice for subcontract machining companies.

FORCE M carbide drills have been engineered to provide the highest performance and process reliability when drilling Stainless steels and Heat resistant super alloys. FORCE M drills are ideal for applications where it is necessary to drill a large number of holes with high and constant accuracy.

FORCE N carbide drills are recommended for high-speed drilling operations in wrought and cast aluminum alloys. The flute and cutting geometry are specifically designed to break the swarf into small manageable chips to enhance chip evacuation. FORCE N drills provide superior performance and tool life for mid-high volume manufacturing companies.

(for more information see Dormer Pramet Holemaking catalogue)



Shark taps

Dormer's application-based ranges of DIN taps, branded Shark Line, are renowned for their high performance and are easily recognizable by their colored rings, denoting recommendation for use on specific materials. *(for more information see Dormer Pramet Threading catalogue)*



Carbide rotary burrs

Our range of carbide rotary burrs is a high quality and comprehensive program. This includes a variety of designs and shapes to offer an ideal option for the majority of applications in all major industry segments.





MACHINING OF BOGIE PARTS – INDEXABLE TOOLS

Standard square shoulder-, face- and high feed milling cutters and drilling tools for machining of side frames, bolsters, bearing houses and other bogie parts.

J(T)-SAD16E, HELICAL AD, Long Edge End Mill for AD.. Insert for Medium Milling

900 long edge end mill for positive AD.. 16 inserts with APMX of 40 up to 108 mm with coolant through. Suited for shoulder, slot, face or plunge milling. Available in arbor, ISO, BT and 2080 taper mounting, in ϕ 50 up to ϕ 100 mm. Available with differential tooth setting.



HELICAL AD



FORCE AD16

FORCE AD16 Square Shoulder Mill with Internal Coolant

900 end and shell mills utilizing positive AD.. 16 style insert with APMX of 13 mm. Suitable for face, shoulder, slot, helical, trochoidal, ramping and plunge milling. Available in cylindrical, weldon, morse taper, modular and arbor (with differential tooth pitch) style, in ϕ 25 up to ϕ 175 mm.



FEED ZD, High-Feed Milling Cutter with Coolant Through

High productive high-feed milling cutter with double sided ZD.. 07; ZD.. 09 or ZD.. 12 insert with 8 cutting edges and a APMX of 1.0 up to 1.6 mm. Suited for a wide range of applications. Available in cylindrical, modular and arbor mounting, in range of ϕ 16 up to ϕ 80 mm.



FEED ZD



Indexable Insert Drill with Internal Coolant Feed

High performance indexable insert drill for drilling blind and trough holes and potentially cross-, off center-, helical and stacked material drilling, plunging, drilling on concave or sloped surfaces, drilling with interrupted cuts, chamfer drilling and even boring type drilling.

Available from ϕ 15 up to ϕ 40 mm in 2xD, from ϕ 15 up to ϕ 58 mm in 3xD, from ϕ 17 up to ϕ 58 mm in 4xD and from ϕ 19 up to ϕ 31 mm in 5xD.



ECON HN

SHN06C and SHN09C, ECON HN, 45° Face Mill with Double Negative Design and Internal Coolant

Highly productive 45° face mill utilizing double sided HN.. 06 or HN.. 09 style inserts with APMX of 3 mm and 5 mm. Roughing, finishing and chamfering. Economical insert with 12 cutting edges. Differential tooth pitch.

SHN06C: Weldon, screw and arbor mounting available, in range from ϕ 25 up to ϕ 125 mm.

SHN09C: Arbor mounting only, in range from ϕ 50 up to ϕ 315 mm.

The comprehensive range of technology we offer for the machining of couplers is an example of our capabilities in the wagon production segment.

1 – Special porcupine milling cutter

ø 100 mm cutter, for machining of the walls with high APMX up to 150 mm. Productive solution due to the strong body design with 4 effective teeth and tangential inserts usage.

2 – Special porcupine milling cutter for milling in narrow slots

Milling cutter with ø 36 mm and APMX of 70 mm for milling of the 90° walls in narrow slots. Tangential inserts with chip-breaker must be used because of the long tool overhang.

3 – Special step drill

Drilling of ø 32 mm and ø 50 mm together with finishing of the top face with maximum ø 100 mm. Strong and rigid solid body design with usage of standard drilling inserts. Maximum hole depth 145 mm.

4 – Special tapered mono-block cutter – 70°

Milling cutter ø 77 mm with APMX of 70 mm for machining of the tapered 70° wall and the bottom surface.

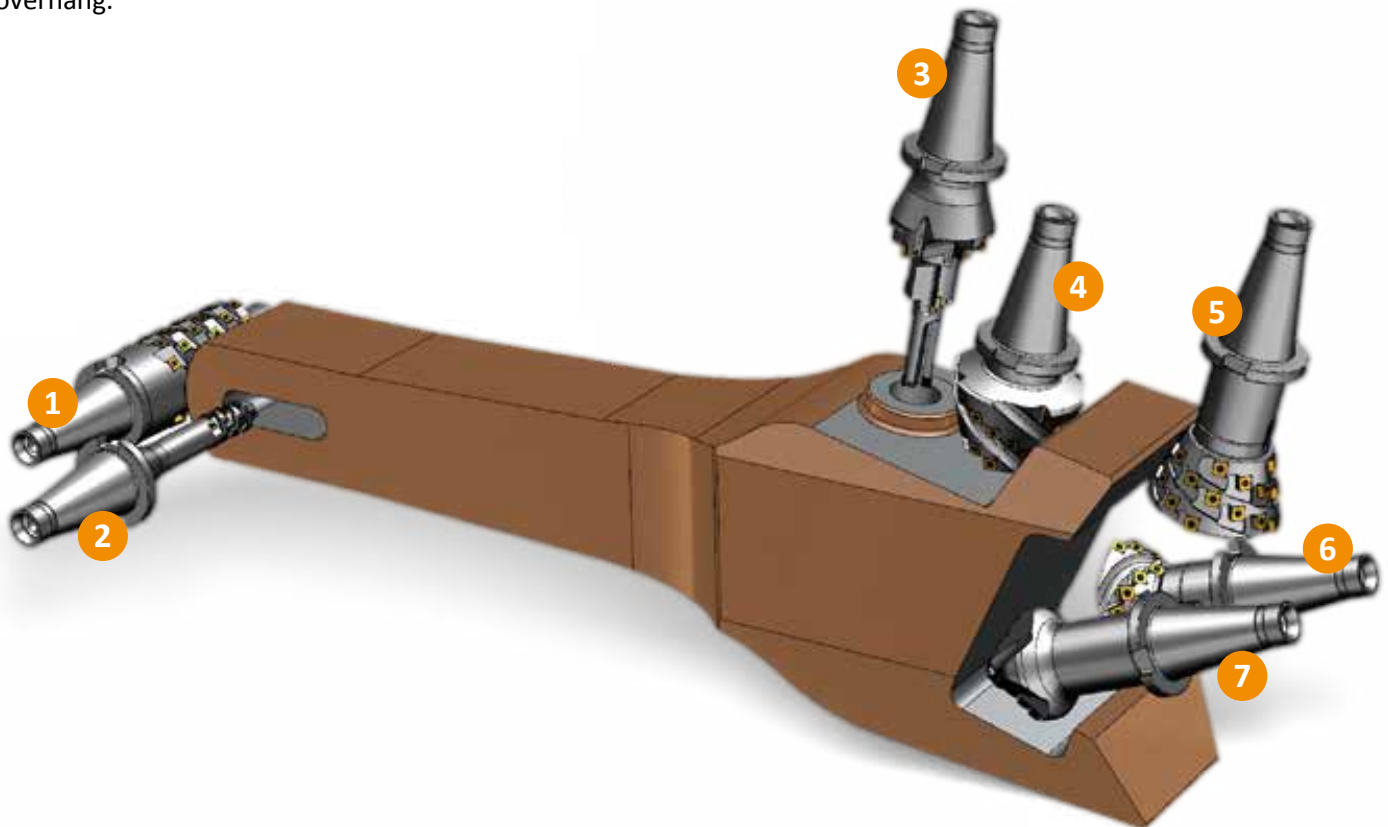

5 – Special inverted tapered milling cutter – 108°

Milling cutter for machining of inverted tapered surfaces with an angle of 108°. Maximum ø 130 mm and APMX of 65 mm. Cutter is equipped with rigid tangential inserts with 8 cutting edges. Smooth helix ensures the soft cut.

6 – Special inverted tapered milling cutter – 131°

Milling cutter for machining of inverted tapered surfaces with an angle of 131°. Maximum ø 138 mm and APMX of 40 mm. Cutter is equipped with rigid tangential inserts with 8 cutting edges. Smooth helix ensures the soft cutting process.

7 – Special tapered mono-block cutter – 47°

Special tapered milling cutter with minimum ø 15 mm and APMX of 46 mm. Standard, sharp, radial inserts and large flutes ensure the smooth cutting process and easy chips evacuation.



DORMER PRAMET



ALL TOOLS TOGETHER

Our entire assortment of rounds tools and indexables is included within the machining calculator app. That's more than **40,000** items! Whatever your machining we're likely to have something for it. **Simply Reliable.**

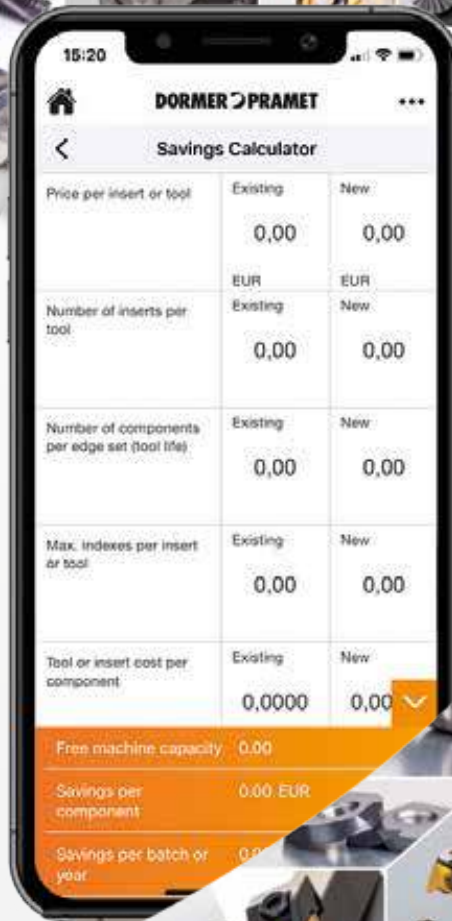



WORKPIECE MATERIAL GROUPS (WMG)

ISO To select a cutting grade and geometry for a broad range of workpiece materials

General definition
i.e. Steel, Stainless Steel...

P **M** **K** **N** **S** **H**

Subgroup To navigate and select a tool by suitability for a more specific range of workpiece materials

Definition by structure/composition
i.e. Plain Carbon Steel, Alloy Steel...

P **M** **K** **N** **S** **H**

P1

P2

P3

P4

WMG To select and provide cutting conditions within a bandwidth of $\pm 10\%$

Definition by hardness/ultimate tensile strength
i.e. $160 < 220$ HB, $620 < 900$ N/mm² ...

P

P1 **P1.1** **P1.2** **P1.3**

P2 **P2.1** **P2.2** **P2.3**

P3 **P3.1** **P3.2** **P3.3**

P4 **P4.1** **P4.2** **P4.3**

ABOUT DORMER PRAMET'S WORKPIECE MATERIAL CLASSIFICATION

Workpiece **Material Groups (WMG)** are used to support easy and reliable selection of the right cutting tool and starting values for machining conditions in particular applications.

Dormer Pramet classifies workpiece materials into six different coloured groups;

- **Blue:** Steel and cast steel (P-group)
- **Yellow:** Stainless steel (M-group)
- **Red:** Cast iron (K-group)
- **Green:** Non-ferrous metals (N-group)
- **Brown:** High-temperature alloys (S-group)
- **Grey:** Hardened materials (H-group)

Each of these are divided into subgroups on the basis of their structure and/or composition. For example, P-group steel and cast steel is split into four subgroups, namely;

- **P1** – Free machining steel
- **P2** – Plain carbon steel
- **P3** – Alloy steel
- **P4** – Tool steel

A final division includes material properties, such as hardness and ultimate tensile strength. This is to provide our customers with a complete tool recommendation, including starting values for cutting speed and feed.

The table on the next page includes a description of each workpiece material group, as well as examples of commonly used designations.



WMG (WORK MATERIAL GROUP)

ISO group	WMG (Work Material Group)	Hardness (HB or HRC)	Ultimate Tensile Strength (MPa)					
P	P1	P1.1	Sulfurized	< 240 HB	≤ 830			
		P1.2	Free machining steel (carbon steels with increased machinability)	Sulfurized and phosphorized	< 180 HB	≤ 620		
		P1.3		Sulfurized/phosphorized and leaded	< 180 HB	≤ 620		
	P2	P2.1	Plain carbon steel (steels comprised of mainly iron and carbon)	Containing <0.25 % C	< 180 HB	≤ 620		
		P2.2		Containing <0.55 % C	< 240 HB	≤ 830		
		P2.3		Containing >0.55 % C	< 300 HB	≤ 1030		
	P3	P3.1	Alloy steel (carbon steels with an alloying content ≤ 10%)	Annealed	< 180 HB	≤ 620		
		P3.2		Hardened and tempered	180 – 260 HB	> 620 ≤ 900		
		P3.3			260 – 360 HB	> 900 ≤ 1240		
	P4	P4.1	Tool steel (special alloy steel for tools, dies and molds)	Annealed	< 26 HRC	≤ 900		
P4.2		Hardened and tempered		26 – 39 HRC	> 900 ≤ 1240			
P4.3				39 – 45 HRC	> 1240 ≤ 1450			
M	M1	M1.1	Ferritic stainless steel (straight chromium non-hardenable alloys)	< 160 HB	≤ 520			
				160 – 220 HB	> 520 ≤ 700			
	M2	M2.1	Martensitic stainless steel (straight chromium hardenable alloys)	Annealed	< 200 HB	≤ 670		
				Quenched and tempered	200 – 280 HB	> 670 ≤ 950		
				Precipitation-hardened	280 – 380 HB	> 950 ≤ 1300		
	M3	M3.1	Austenitic stainless steel (chromium-nickel and chromium-nickel-manganese alloys)	< 200 HB	≤ 750			
				200 – 260 HB	> 750 ≤ 870			
				260 – 300 HB	> 870 ≤ 1040			
	M4	M4.1	Austenitic-ferritic (DUPLEX) or super-austenitic stainless steel	< 300 HB	≤ 990			
		M4.2	Precipitation hardening austenitic stainless steel	300 – 380 HB	≤ 1320			
K	K1	K1.1	Gray iron or Automotive Gray iron (GG) (iron-carbon castings with a lamellar graphite microstructure)	Ferritic or ferritic-pearlitic	< 180 HB	≤ 190		
				Ferritic-pearlitic or pearlitic	180 – 240 HB	> 190 ≤ 310		
				Pearlitic	240 – 280 HB	> 310 ≤ 390		
	K2	K2.1	Malleable iron (GTS/GTW) (iron-carbon castings with a graphite-free microstructure)	Ferritic	< 160 HB	≤ 400		
				Ferritic or pearlitic	160 – 200 HB	> 400 ≤ 550		
				Pearlitic	200 – 240 HB	> 550 ≤ 660		
	K3	K3.1	Ductile iron (GGG) (iron-carbon castings with a nodular graphite microstructure)	Ferritic	< 180 HB	≤ 560		
				Ferritic or pearlitic	180 – 220 HB	> 560 ≤ 680		
				Pearlitic	220 – 260 HB	> 680 ≤ 800		
	K4	K4.1	Austenitic gray iron (ASTM A436) (iron-carbon alloy castings with an austenitic lamellar graphite microstructure)	< 180 HB	≤ 190			
< 240 HB				≤ 740				
K4.2		Austenitic ductile iron (ASTM A439 or ASTM A571) (iron-carbon alloy castings with an austenitic nodular graphite microstructure)	< 280 HB	> 840 ≤ 980				
			280 – 320 HB	> 980 ≤ 1130				
			320 – 360 HB	> 1130 ≤ 1280				
K5	K5.1	Compacted graphite iron CGI (ASTM A842) (iron-carbon castings with a vermicular graphite structure)	Ferritic	< 180 HB	≤ 400			
			Ferritic-pearlitic	180 – 220 HB	> 400 ≤ 450			
			Pearlitic	220 – 260 HB	> 450 ≤ 500			
N	N1	N1.1	Commercially pure wrought aluminium	< 60 HB	≤ 240			
				N1.2	Wrought aluminium alloys	Half hard tempered	60 – 100 HB	> 240 ≤ 400
						Full hard tempered	100 – 150 HB	> 400 ≤ 590
	N2	N2.1	Cast aluminium alloys	< 75 HB	≤ 240			
				75 – 90 HB	> 240 ≤ 270			
				90 – 140 HB	> 270 ≤ 440			
	N3	N3.1	Free-cutting copper-alloys materials with excellent machining properties	–	–			
				N3.2	Short-chip copper-alloys with good to moderate machining properties	–	–	
						N3.3	Electrolytic copper and long-chip copper-alloys with moderate to poor machining properties	–
	N4	N4.1	Thermoplastic polymers	–	–			
N4.2				Thermosetting polymers	–	–		
					N4.3	Reinforced polymers or composites	–	–
N5	N5.1	Graphite	–	–				
S	S1	S1.1	Titanium or titanium alloys	< 200 HB	≤ 660			
				200 – 280 HB	> 660 ≤ 950			
				280 – 360 HB	> 950 ≤ 1200			
	S2	S2.1	Fe-based high-temperature alloys	< 200 HB	≤ 690			
				200 – 280 HB	> 690 ≤ 970			
	S3	S3.1	Ni-based high-temperature alloys	< 280 HB	≤ 940			
				280 – 360 HB	> 940 ≤ 1200			
	S4	S4.1	Co-based high-temperature alloys	< 240 HB	≤ 800			
240 – 320 HB				> 800 ≤ 1070				
H	H1	H1.1	Chilled cast iron	< 440 HB	–			
				H2	Hardened cast iron	< 55 HRC	–	
	H2	H2.1	Hardened steel < 55 HRC	> 55 HRC	–			
				< 51 HRC	–			
	H3	H3.1	Hardened steel > 55 HRC	51 – 55 HRC	–			
				55 – 59 HRC	–			
	H4	H4.1	Hardened steel > 55 HRC	> 59 HRC	–			
				–	–			



RAILWAY – TURNING ASSORTMENT

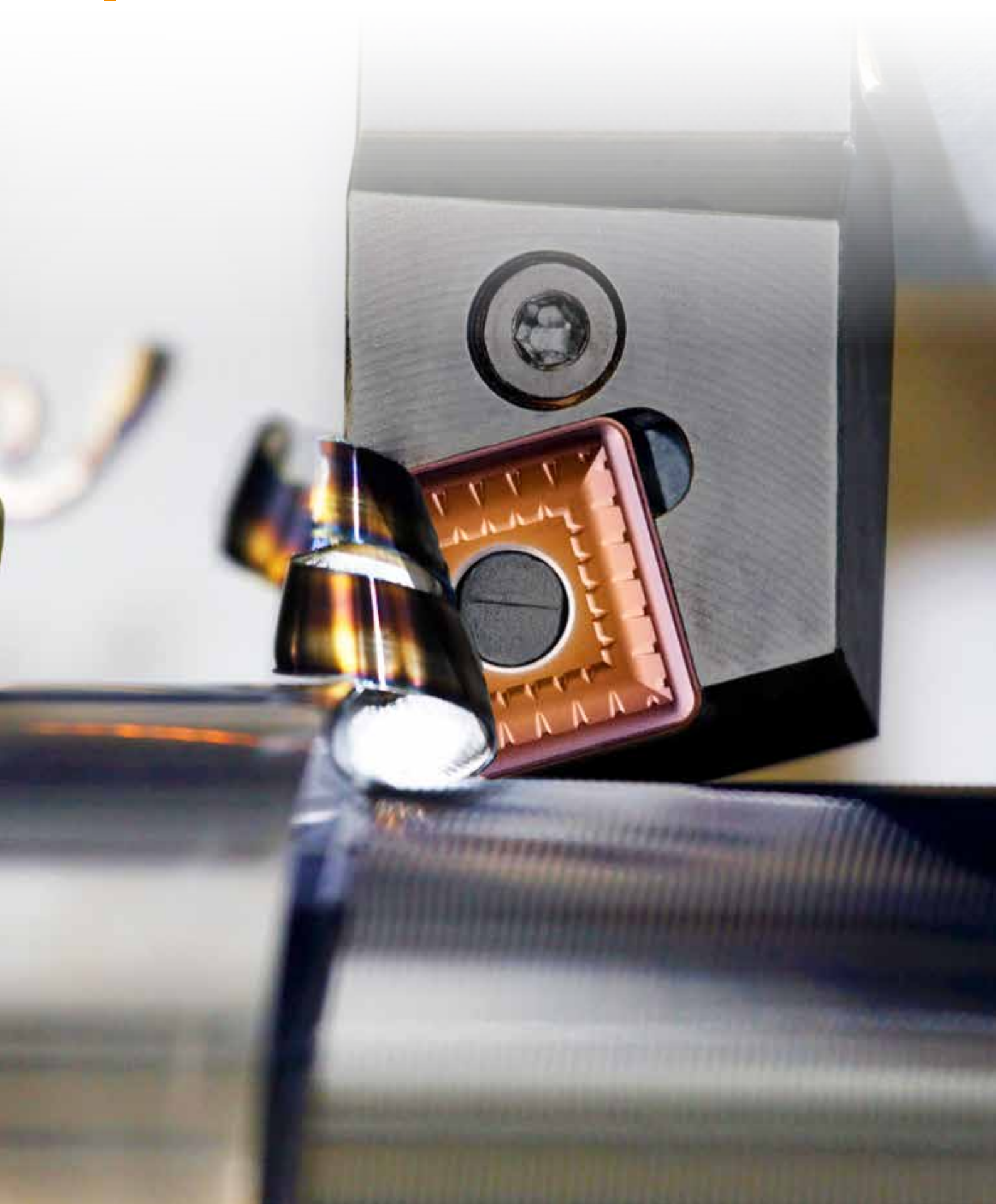



7		INTRODUCTION & ASSORTMENT HIGHLIGHTS
13	RAILWAY INDUSTRY	PRODUCTION OF NEW RAILWAY WHEELS
20		RAILWAY WHEEL RECONDITIONING
26		AXLES MACHINING
30		STATIONARY & DYNAMIC RAIL MILLING
37		TURNOUTS MACHINING
57		BASE PLATES MACHINING
63		WAGON & BOGIE PARTS MACHINING
73		TURNING ASSORTMENT
88	POSITIVE INSERTS	
107	NEGATIVE INSERTS	
146		INDEXABLE MILLS
166		TECHNICAL PART



DORMER PRAMET



QUICK SEARCH

Easily and quickly perform a text search within any publication launched by Dormer Pramet in recent time through our library app. Download it today from your relevant app store. **Simply Reliable.**

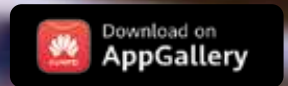



CUTTING TOOL PARAMETERS ACCORDING TO ISO 13399

All cutting tools are defined by a number of parameters according to the standard ISO 13399. This list contains all the parameters used in this catalogue and their definitions.

ISO 13399 is an international cutting tool information standard. It provides dimensions and parameters in a neutral format that is independent of any particular system or company nomenclature. When cutting tools are clearly defined according to a global standard, all types of software can process the electronic data more quickly, improving the quality of communication and helping to make the exchange of information run smoothly. Supporting a common language in our cutting tool descriptions this will assist system to system communication. It will save you a significant amount of time, providing an easier gathering of high-quality data across our 40,000 solid and indexable tools. By using an ISO 13399 compliant system, there will be no need to manually interpret data and key-enter it into your system.

EXAMPLES ONLY!

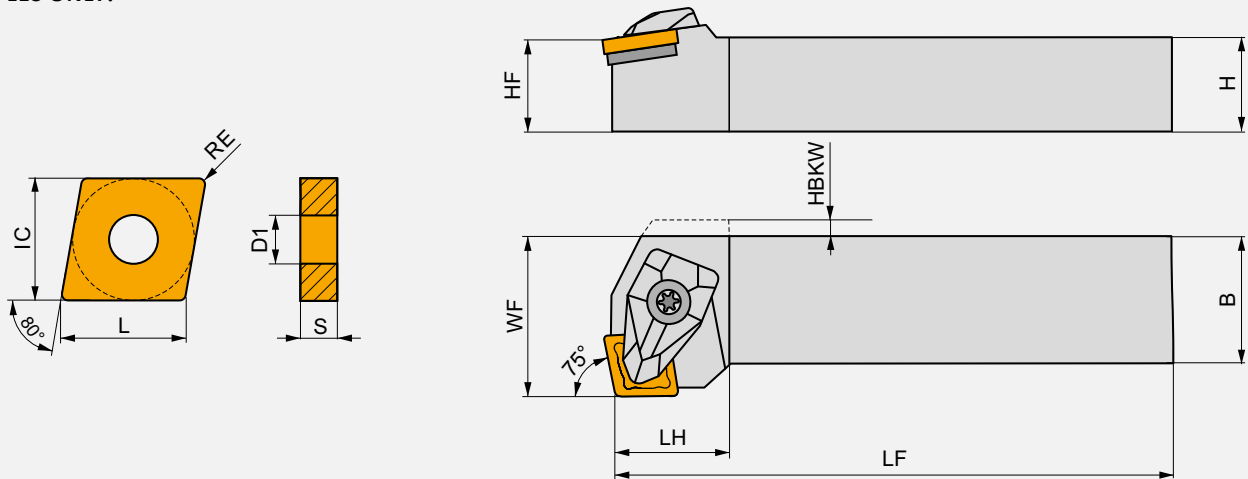

ISO 13399	Description
APMX	Depth of cut maximum
B	Shank width
BD	Body diameter
BLRAD	Blade reinforcement radius
BW	Insert body width
CDX	Cutting depth maximum
CND	Coolant entry diameter
CUTDIA	Work piece parting diameter maximum
CW	Cutting width
CWTOLL	Cutting width lower tolerance
CWTOLU	Cutting width upper tolerance
D1	Fixing hole diameter
DAXIN	Minimum axial groove inside diameter
DAXN	Minimum axial groove outside diameter
DAXX	Maximum axial groove outside diameter
DCON MS	Connection diameter
DMIN	Minimum bore diameter
DMINP	Minimum bore diameter perpendicular
GAMO	Orthogonal rake angle
GAMP	Axial rake angle
H	Shank height
HBH	Head bottom offset height
HBKW	Head bottom offset width
HF	Functional height
IC	Inscribed circle diameter
INSD	Insert diameter
INSL	Insert length

ISO 13399	Description
KAPR	Tool cutting edge angle
L	Cutting edge length
LAMS	Inclination angle
LB	Body length
LF	Functional length
LFA	A dimension on LF
LFS	Functional length secondary
LH	Head length
LU	Usable length
M	M-dimension
OAL	Overall length
PDX	Profile distance X
PDY	Profile distance Y
PSIRL	Tool lead angle left
PSIRR	Tool lead angle right
RE	Corner radius
S	Insert thickness
S1	Insert thickness total
TP	Thread pitch
TPI	Threads per inch
TPIN	Threads per inch
TPIX	Threads per inch
TPN	Thread pitch minimum
TPX	Thread pitch maximum
W1	Insert width
WF	Functional width
WFS	Functional width secondary



1 CNMM

	IC [mm]	D1 [mm]	L [mm]	S [mm]
1204	12.700	5.16	12.90	4.76
1606	15.875	6.35	16.10	6.35
1906	19.050	7.94	19.30	6.35
2509	25.400	9.12	25.80	9.53

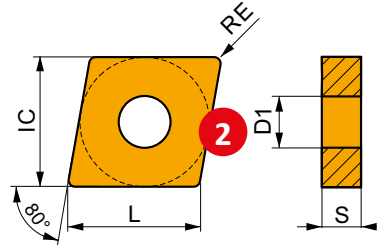

Suitability and starting values for cutting speed (vc), feed (f) and depth of cut (ap). Refer to our Machining Calculator app for further calculations.

Product	RE [mm]	P			M			K			N			S			H		
		vc [m/min]	f [mm/rev]	ap [mm]	vc [m/min]	f [mm/rev]	ap [mm]	vc [m/min]	f [mm/rev]	ap [mm]	vc [m/min]	f [mm/rev]	ap [mm]	vc [m/min]	f [mm/rev]	ap [mm]	vc [m/min]	f [mm/rev]	ap [mm]

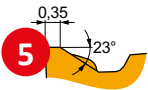

10 DR geometry for semi-rough to rough machining, and continuous to interrupted cuts.

CNMM 160612E-DR	T9315	1.2	225	0.45	6.0	–	–	–	210	0.45	6.0	–	–	–	–	–	–	–
	T9315	1.2	200	0.45	6.0	120	0.41	6.0	190	0.45	6.0	–	–	–	–	–	–	–
	T9335	1.2	170	0.45	6.0	100	0.41	6.0	–	–	–	–	–	–	–	–	–	–
CNMM 190608E-DR	T9315	0.8	215	0.40	8.0	–	–	–	200	0.40	8.0	–	–	–	–	–	–	–
	T9325	0.8	190	0.40	8.0	110	0.36	8.0	180	0.40	8.0	–	–	–	–	–	–	–
CNMM 190612E-DR	T9315	1.2	220	0.45	8.0	–	–	–	205	0.45	8.0	–	–	–	–	–	–	–
	T9325	1.2	195	0.45	8.0	115	0.41	8.0	185	0.45	8.0	–	–	–	–	–	–	–
	T9335	1.2	170	0.45	8.0	100	0.41	8.0	–	–	–	–	–	–	–	–	–	–
CNMM 190616E-DR	T9325	1.6	195	0.50	9.0	115	0.45	9.0	185	0.50	9.0	–	–	–	–	–	–	–
	T9335	1.6	170	0.50	9.0	100	0.45	9.0	–	–	–	–	–	–	–	–	–	–

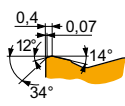

HR geometry for rough to heavy-rough machining, and continuous to interrupted cuts.

CNMM 190616E-HR	6640	1.6	75	0.60	10.0	45	0.54	10.0	70	0.60	10.0	–	–	–	–	–	–	–
	T8345	1.6	55	0.60	10.0	30	0.54	10.0	50	0.60	10.0	–	–	–	–	–	–	–
	T9325	1.6	105	0.60	10.0	60	0.54	10.0	95	0.60	10.0	–	–	–	–	–	–	–
	T9335	1.6	80	0.60	10.0	45	0.54	10.0	–	–	–	–	–	–	–	–	–	–

CNMM190616E-HR:T8345 Use full insert specification code when ordering!

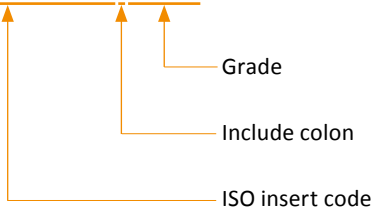



TURNING INSERTS – PAGE OVERVIEW

Pos.	Description	Pos.	Description
1	Designation of insert	7	ISO insert code
2	Schematic drawing of insert	8	Grade
3	Table with insert sizes (mm)	9	Insert radii (mm)
4	Picture of representative insert	10	Geometry description
5	Profile of main cutting edge	11	Application area of insert
6	Icons – specific features and cutting edge type		

1 DDUN(RL) INT **P M K N S I 2** **PRAMET 3** **D**



Internal Double Clamp Boring Bar with 93° Cutting Angle for DN.. Insert
 Internal Right/Left hand double clamp boring bar, through coolant, 93° cutting angle for DN.. 11 and 15 inserts. Minimum internal turning diameter Ø32 mm. Suited for wide range of internal turning applications, copy turning up to 27°. Available with shank size Ø25 up to Ø50 mm. Body treated for longer tool life.

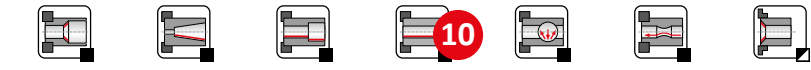
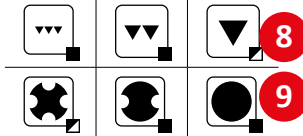
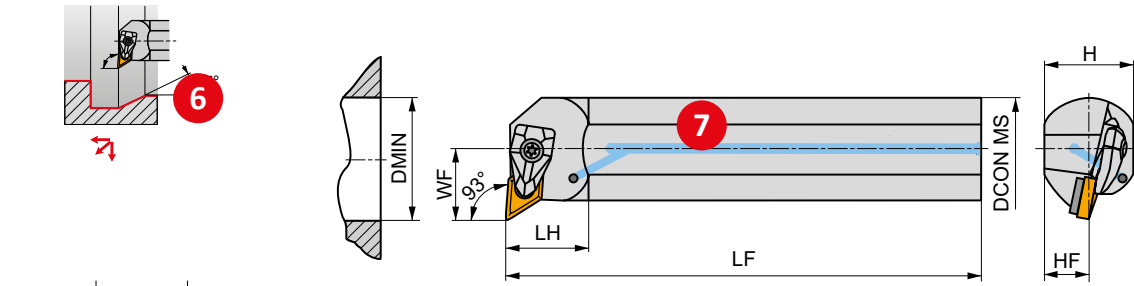

Product	DCON MS [mm]	DMIN [mm]	WF [mm]	H [mm]	HF [mm]	LF [mm]	LH [mm]	LAMS [°]	GAMO [°]	✓	kg	GI046	DD11	AT002
R A25T-DDUNR 11	25	32	17	23	11.5	300	28	-12	-6	✓	0.96	GI046	DD11	-
A32T-DDUNR 11	32	40	22	30	15	300	30	-10	-6	✓	1.68	GI046	DD11	-
A40T-DDUNR 15	40	50	27	37	18.5	300	36	-11	-6	✓	2.59	GI044	DD154	AT002
A50U-DDUNR 15	50	63	35	47	23.5	350	39	-8	-6	✓	5.25	GI044	DD154	AT002
L A25T-DDUNL 11	25	32	17	23	11.5	300	28	-12	-6	✓	0.96	GI046	DD11	-
A32T-DDUNL 11	32	40	22	30	15	300	30	-10	-6	✓	1.69	GI046	DD11	-
A40T-DDUNL 15	40	50	27	37	18.5	300	36	-11	-6	✓	2.59	GI044	DD154	AT002
A50U-DDUNL 15	50	63	35	47	23.5	350	39	-8	-6	✓	5.25	GI044	DD154	AT002

GI044	DN.. 1506..	19
GI046	DN.. 1104..	

DD11	DCS 09	1.7	DDS 267-01	US 2004-T09P	FLAG T09P	20
DD154	DCS 12	3.9	DDS 266-02	US 2002-T15P	FLAG T15P/3,5	

AT002a	DN.. 1504..	-	DDS 266-01	21
AT002b	CER DN.N 1506..	DCS 12C4	-	
AT002c	CER DN.A 1506..	DCS 12C2	-	



TURNING HOLDERS – PAGE OVERVIEW

Pos.	Description
1	Designation of turning holder
2	Material group recommendations
3	Clamping system of insert
4	Illustrative picture ¹⁾
5	Tool description
6	Workpiece profile
7	Schematic drawing of tool
8	Achievable quality of surface
9	Character of cut/working conditions
10	Product applications
11	Tool design

Pos.	Description
12	ISO code of holder
13	Dimensions (mm) and angles ²⁾ (°) of holder
14	Internal coolant supply
15	Weight (kg)
16	Group of compatible inserts ³⁾
17	Group of spare parts ^{3),4)}
18	Group of accessories ^{3),4)}
19	Compatible inserts
20	Spare parts
21	Special accessories

¹⁾ Turning holder is primarily displayed in its right design (R)

²⁾ GAMO = orthogonal rake angle (see technical pages)

LAMS = inclination angle of main cutting edge (see technical pages)

³⁾ Code of Group of compatible inserts, spare parts and special accessories is used only for purposes of this catalogue. It cannot be used for orders.

⁴⁾ Spare parts and special accessories icons are designed schematically for ease of understanding. They aren't included in list of icons. Screws are, in some cases, completed with info on torque value in Nm, length of screw and size of thread.



TURNING HOLDERS – ICONS OVERVIEW

GENERAL ICONS

	Primary use		Finishing – very good surface quality		Suitable for stable working conditions
	Possible use		Medium machining – good surface quality		Suitable for unstable working conditions
			Roughing – unlimited surface roughness		Suitable for very unstable working conditions

FEATURES

	First choice		Insert with Wiper geometry		Sharp edge
	For short chipping materials		Large overhang		Rounded edge
	For tough materials (long chipping)		Railway wheel machining		Edge with facet
	Heavy working conditions		Thin-walled and slim workpieces		Rounded edge with facet
	High Feed Cutting		Universal wide range option		Edge with double facet
	High Speed Cutting				Rounded edge with double facet





















TURNING OPERATIONS

	Cone turning – external		Chamfering (beveling)		Machining the rear face (shoulder) from the back
	Cone turning – internal		Chamfering (beveling) from the back		Multi directional copy turning – external
	Copy turning (multi directional machining)		Chamfering (beveling) in hole		Multi directional copy turning – internal
	Face copy turning		Longitudinal turning with shoulder – external		One directional copy turning – external
	Face copy turning in hole		Longitudinal turning with shoulder – internal		One directional copy turning – internal
	Face turning with shoulder		Longitudinal turning without shoulder – external		Shallow radial groove
	Face turning without shoulder		Longitudinal turning without shoulder – internal		



TURNING HOLDERS – ICONS OVERVIEW

TECHNICAL PAGES

	Fine finishing		Feed (mm/rev)		Very high cutting speed, excellent system rigidity (stable working conditions)
	Finishing		Durability (min)		High cutting speed, high system rigidity (stable working conditions)
	Medium machining		Grade		High cutting speed, system rigidity slightly limited (depth of cut changing)
	Roughing		Coating		Medium cutting speed, system rigidity limited (slightly interrupted cut)
	Heavy roughing		Cutting speed		Low cutting speed, low system rigidity (interrupted cut)
	Multiplication factor for cutting speed		Cutting edge profile		Very low cutting speed, very low system rigidity (very unstable working conditions)
	Depth of cut (mm)		Cooling		

OTHERS

	Clamping torque of screw (Nm)		Group of heads for roughing		Internal supply of coolant
---	-------------------------------	---	-----------------------------	---	----------------------------

ISO TURNING – EXTERNAL

LONG AND UNSTABLE COMPONENTS (positive inserts)

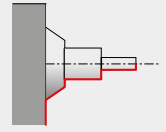

SRDCN EXT	
RC..	
	06
	08
	10
	12
	16
	12x12 32x25
	100
	92 – 97

SRSC(RL) EXT	
RC..	
	06
	08
	10
	12
	16
	12x12 32x25
	101
	92 – 97

C.-SRDCN EXT	
RC..	
	10
	12
	C4 C5
	102
	92 – 97

ISO TURNING - HEAVY ROUGHING - EXTERNAL

FIXED TOOL HOLDERS AND HEAD (KH)

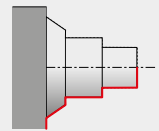

PRDCN EXT	
RC..	
	16
	20
	25
	32
	32x25 50x50
	98
	92 – 97

PRSC(RL) EXT	
RC..	
	16
	20
	25
	32x25 40x40
	99
	92 – 97

KHP-RSCR/L + DKH(RL)	
RC..	
	20
	25
	32
	40x50 60x80
	103 - 104
	92 – 97



ISO TURNING – HEAVY ROUGHING – EXTERNAL
RAILWAY WHEEL MACHINING

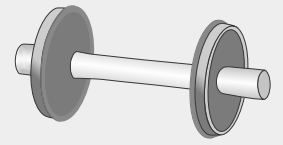

DKT(RL)-A1 + KTP			
	CN..	LN..	SN..
	19	19 30	19
	KTP-CAN(RL)	KTP-LAN(RL)	KTP-SAN(RL)
50x55			
112, 124, 135	111 119	122 131	134 142

DKT(RL)-A2 + KTP			
	CN..	LN..	SN..
	19	19 30	19
	KTP-CAN(RL) KTP-CFN(RL)	KTP-LAN(RL) KTP-LFN(RL)	KTP-SAN(RL) KTP-SFN(RL)
50x55			
112, 124, 135	111 119-120	122 131-132	134 142-143

DKT(RL)-B1 + KTP			
	CN..	LN..	SN..
	19	19 30	19
	KTP-CAN(RL)	KTP-LAN(RL)	KTP-SAN(RL)
50x49.5			
113, 125, 136	111 119	122 131	134 142

DKT(RL)-B2 + KTP			
	CN..	LN..	SN..
	19	19 30	19
	KTP-CAN(RL) KTP-CFN(RL)	KTP-LAN(RL) KTP-LFN(RL)	KTP-SAN(RL) KTP-SFN(RL)
50x49.5			
113, 125, 136	111 119-120	122 131-132	134 142-143

DKT(RL)-C1 + KTP			
	CN..	LN..	SN..
	19	19 30	19
	KTP-CAN(RL)	KTP-LAN(RL)	KTP-SAN(RL)
55x55			
114, 126, 137	111 119	122 131	134 142

DKT(RL)-C2 + KTP			
	CN..	LN..	SN..
	19	19 30	19
	KTP-CAN(RL) KTP-CFN(RL)	KTP-LAN(RL) KTP-LFN(RL) KTP-LAN(RL)30/X	KTP-SAN(RL) KTP-SFN(RL)
55x55 55x52			
114, 126, 137	111 119-120	122 131-132	134 142-143

DKT(RL)-D1 + KTP			
	CN..	LN..	SN..
	19	19 30	19
	KTP-CAN(RL)	KTP-LAN(RL)	KTP-SAN(RL)
50x49.5			
115, 127, 138	111 119	122 131	134 142

DKT(RL)-D2 + KTP			
	CN..	LN..	SN..
	19	19 30	19
	KTP-CAN(RL) KTP-CFN(RL)	KTP-LAN(RL) KTP-LFN(RL)	KTP-SAN(RL) KTP-SFN(RL)
50x49.5			
115, 127, 138	111 119-120	122 131-132	134 142-143

S-DKT(RL)4065X-C	
	CN..
	19
45x65	
116	111

S-DKT(RL)4065X-S	
	SN..
	19
45x65	
129, 140	134

S-DKT(RL)4065X + KTP			
	CN..	LN..	SN..
	19	19 30	19
	KTP-CAN(RL) KTP-CFN(RL)	KTP-LAN(RL) KTP-LFN(RL)	KTP-SAN(RL) KTP-SFN(RL)
45x65			
117	111 119-120	122 131-132	134 142-143

S-DKT(RL)5556 + KTP			
	CN..	LN..	SN..
	19	19 30	19
	KTP-CAN(RL) KTP-CFN(RL)	KTP-LAN(RL) KTP-LFN(RL)	KTP-SAN(RL) KTP-SFN(RL)
56x55			
118, 130, 141	111 119-120	122 131-132	134 142-143

INSERTS – ISO CODE DESIGNATION

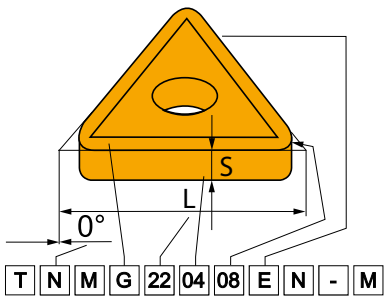

ISO

ANSI

1	2	3	4
T	N	U	N
T	N	M	G
1	2	3	4
T	N	U	
T	N	M	G

1				2		4	
Insert shape				Insert clearance angle		Insert type	
H 	O 	P 	R 	A 	B 	N 	
S 	T 	C 	D 	C 	D 	R 	
E 	M 	V 	W 	E 	F 	F 	
L 	A 	B 	K 	G 	N 	A 	
				P 	O Special	T 	
						U 	
						B 	
						H 	
						C 	
						J 	
						X Special	

3							3		
Tolerances									
	(mm)			(")					
	M (±)	S (±)	IC (±)	M (±)	S (±)	IC (±)			
A	0.005	0.025	0.025	.0002"	.001"	.0010"			
F	0.005	0.025	0.013	.0002"	.001"	.0005"			
C	0.013	0.025	0.025	.0005"	.001"	.0010"			
H	0.013	0.025	0.013	.0005"	.001"	.0005"			
E	0.025	0.025	0.025	.0010"	.001"	.0010"			
G	0.025	0.130	0.025	.0010"	.005"	.0010"			
J	0.005	0.025	0.05 – 0.13	.0002"	.001"	.002 – 0.005"			
K	0.013	0.025	0.05 – 0.13	.0005"	.001"	.002 – 0.005"			
L	0.025	0.025	0.05 – 0.13	.0010"	.001"	.002 – 0.005"			
M	0.08 – 0.18	0.130	0.05 – 0.13	.003 – 0.007"	.005"	.002 – 0.005"			
N	0.08 – 0.18	0.025	0.05 – 0.13	.003 – 0.007"	.001"	.002 – 0.005"			
U	0.05 – 0.38	0.130	0.05 – 0.13	.005 – 0.015"	.005"	.003 – 0.010"			

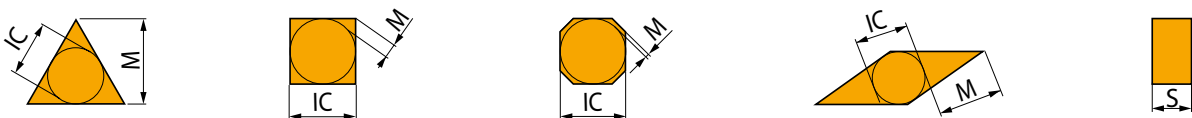

INSERTS – ISO CODE DESIGNATION

5	6	7	8	9	10
22	04	08			
22	04	08	E	N	M
5	6	7	8	9	10
4	3	2			
4	3	2	E	N	M

5		5												
Insert cutting edge length (insert size)														
d = IC		H	O	P	S	T	C	D	E	M	V	W	R	K
(mm)	(in)													
3.97	5/32"				03	06		04			06	02		
4.76	3/16"				04	08	04	05	04	04	08	L3		
5.56	7/32"				05	09	05	06	05	05	09	03		
6.35	1/4"	03	02	04	08	11	06	07	08	08	11	04	06	
7.94	5/16"	04	03	05	07	13	08	09	06	07	13	05	07	
9.525	3/8"	05	04	07	09	16	09	11	09	09	16	06	09	16
12.7	1/2"	07	05	09	12	22	12	15	13	12	22	08	12	
15.875	5/8"	09	06	11	15	27	16	19	16	15	27	10	15	
19.05	3/4"	11	07	13	19	33	19	23	19	19	33	13	19	
25.40	1"	14	10	18	25	44	25	31	26	25	44	17	25	
31.75	1 1/4"	18	13	23	31	54	32	38	32	31	54	21	31	

6		7	
Insert thickness		Insert nose radius	
	S		
	(mm)	(")	
01	1.59	1/16"	
T1	1.98	5/64"	
02	2.38	3/32"	
03	3.18	1/8"	
T3	3.97	5.32"	
04	4.76	3/16"	
05	5.56	7/32"	
06	6.35	1/4"	
07	7.94	5/16"	
09	9.52	3/8"	

RE	
(mm)	(")
00	0
02	0.2
04	0.4
08	0.8
12	1.2
16	1.6
24	2.4
32	3.2

Round inserts

d = I.C.	
(")	00
(mm)	M0

ANSI		
5	6	7
Inscribed circle	Insert thickness	Insert nose radius
Symbol	Symbol	Symbol
		RE
	(mm)	(mm)
	(")	(")
1	1.588	0
1.2	1.984	0.099
1.5	2.381	0.198
2	3.175	0.397
2.5	3.969	0.794
3	4.763	1.191
3.5	5.556	1.588
4	6.350	1.984
5	7.938	2.381
6	9.525	2.778
7	11.113	3.175
8	12.700	3.571
10	14.288	3.969
12	15.875	4.365

8		8	
Insert cutting edge design			
	Sharp edges		Rounded edges
	Edges with facet		Rounded edges with facet
	Edges with double facet		Rounded edges with double facet

9		9	
Feed direction			
R		N	
L			

10		10	
Chip breaker designation			



EXTERNAL TURNING TOOLS – ISO CODE DESIGNATION

Shank tool	ISO	2	3	4	5	6	7	8	11	12	13
		P	C	L	N	R	- 32	25	L	12	- M
PSC	ISO	1	2	3	4	5	6	9	10	12	
		C4	- D	C	L	N	R	- 27	050	- 12	
Shank tool	ANSI	2	3	4	5	6	7 & 8	12	11		
		D	C	L	N	R	- 16	4	D		

1		2		3				4						
Coupling size		Clamping designation		Insert shape				Holder style – cutting edge angle						
	C	D	P	M	S	X	G	A	B	C	D	D		
	C3	C4	C5	C6	C8			E	F	G	H	J		
	32	40	50	63	80			K	L	M	N	P		
						E	M	V	W	Q	R	S	S	T
						L	A	B	K	U	V	W	X	Y
										Z				

5				6		7 & 8			11	
Insert clearance angle				Direction of cut		Shank width & Shank height (")			Holder total length	
AN				R		Symbol	B (")	H (")		LF (mm)
N	B	C	P	L		05	5/16"	5/16"	D	60
0°	5°	7°	11°	N		06	3/8"	3/8"	E	70
						08	1/2"	1/2"	F	80
						10	5/8"	5/8"	H	100
						12	3/4"	3/4"	J	110
						16	1"	1"	K	125
						85	1"	1 1/4"	L	140
						86	1"	1 1/2"	M	150
						20	1 1/4"	1 1/4"	N	160
						24	1 1/2"	1 1/2"	P	170
						32	2"	2"	Q	180

7					
Shank height (mm)					
08	10	12	16	20	25
32	38	40	45	50	60

8					
Shank width (mm)					
08	10	12	16	20	25
32	38	40	45	50	60

9		10	
Functional width (mm)		Functional length (mm)	

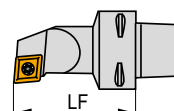
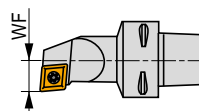

For square shanks, the number is the width or height in terms of 16ths. For rectangular shanks the first digit is the width in terms of 8ths and the second digit is the height in terms of 4ths.

A	4.000"	N	160
B	4.500"	P	170
C	5.000"	Q	180
D	6.000"	R	200
E	7.000"	S	250
F	8.000"	T	300
M	4.000"	U	350
N	4.500"	V	400
R	6.000"	W	450
S	7.000"	X	Spec.
T	8.000"	Y	500



INTERNAL TURNING TOOLS – ISO CODE DESIGNATION

ISO	15	16	17	-	2	3	4	5	6	12	-	14
A	25	T		P	C	L	N	L	12		X	
ANSI	15	16	17	-	2	3	4	5	6	12		
A	16	T		D	C	L	N	L	4			

12		12												
		Insert cutting edge length (insert size)												
d = I.C.		H	O	P	S	T	C	D	E	M	V	W	R	K
(mm)	(")													
3.97					03	06		04			06	02		
	5/32"					1.2								
4.76					04	08	04	05	04	04	08	L3		
	3/16"					1.5								
5.56					05	09	05	06	05	05	09	03		
	7/32"					1.8								
6.35		03	02	04	08	11	06	07	08	08	11	04	06	
	1/4"					2								
7.94		04	03	05	07	13	08	09	06	07	13	05	07	
	5/16"					2.5								
9.525		05	04	07	09	16	09	11	09	09	16	06	09	16
	3/8"					3								
12.7		07	05	09	12	22	12	15	13	12	22	08	12	
	1/2"					4								
15.875		09	06	11	15	27	16	19	16	15	27	10	15	
	5/8"					5								
19.05		11	07	13	19	33	19	23	19	19	33	13	19	
	3/4"					6								
25.40		14	10	18	25	44	25	31	26	25	44	17	25	
	1"					8								
31.75		18	13	23	31	54	32	38	32	31	54	21	31	
	1 1/4"					10								

13	
Manufacturer's designation	
M	Clamping system "S" with shim

14	
Manufacturer's designation	
X	Special shank style
.	
.	
93	Z – style tool setting angle
.	
.	

15		15
Shank		
S	Steel shank	
A	Steel shank with coolant hole	
E	Tungsten carbide shank with coolant hole	

16		16	
Shank Ø (mm)			
DCON MS (mm)		DCON MS (")	
08	8	03	.1875"
10	10	04	.250"
12	12	05	.3125"
16	16	06	.375"
20	20	08	.500"
25	25	10	.625"
32	32	12	.750"
40	40	16	1.000"
50	50	20	1.250"
60	60	24	1.500"
		32	2.000"

17		17	
Holder total Length			
		LF (mm)	
		D	60
		E	70
		F	80
		H	100
		J	110
		K	125
F	LF (")	L	140
H	3.250"	M	150
K	4.000"	N	160
M	5.000"	P	170
P	6.250"	Q	180
Q	7.250"	R	200
R	8.000"	S	250
S	10.000"	T	300
T	12.000"	U	350
U	14.000"	V	400
V	15.750"	W	450
W	17.750"	X	Spec.
Y	20.000"	Y	500
X	Spec.		

HEADS – ISO CODE DESIGNATION

CARTRIDGE

1	2	–	3	4	5	6	7
KH	P		C	L	N	R	25

HOLDER

8	6	9	10	11
DKH	R	50	60	W

1	2	3	4
Cartridge	Clamping designation	Insert shape	Holder style – cutting edge angle
5 Insert clearance angle	C	S	A
	D	C	B
N 0°	P	T	C
C 7°	M	D	D
P 11°	S	R	D
6 Direction of cut	X	K	E
R	S	V	F
L	X	W	G
N	G	X Special	H
			J
			K
			L
			M
			N
			P
			Q
			R
			S
			S
			T
			U
			V
			W
			X Special
			Y
			Z

7		Insert cutting edge length (insert size)												
d = I.C.		H	O	P	S	T	C	D	E	M	V	W	R	K
(mm)	(")													
3.97	5/32"				03	06		04			06	02		
4.76	3/16"				04	08	04	05	04	04	08	L3		
5.56	7/32"				05	09	05	06	05	05	09	03		
6.35	1/4"	03	02	04	08	11	06	07	08	08	11	04	06	
7.94	5/16"	04	03	05	07	13	08	09	06	07	13	05	07	
9.525	3/8"	05	04	07	09	16	09	11	09	09	16	06	09	16
12.7	1/2"	07	05	09	12	22	12	15	13	12	22	08	12	
15.875	5/8"	09	06	11	15	27	16	19	16	15	27	10	15	
19.05	3/4"	11	07	13	19	33	19	23	19	19	33	13	19	
25.40	1"	14	10	18	25	44	25	31	26	25	44	17	25	
31.75	1 1/4"	18	13	23	31	54	32	38	32	31	54	21	31	

8
Cartridge holder

9
Shank height (mm)

08 10 12 16 20 25
32 40 50 60 70 80

10
Shank width (mm)

08 10 12 16 20 25
32 40 50 60 70 80

11
Holder total length

	LF (mm)
H	100
J	110
K	125
L	140
M	150
N	160
P	170
Q	180
R	200
S	250
T	300
U	350
V	400
W	450
X	Spec.
Y	500

ISO CODE DESIGNATION HOLDERS AND CARTRIDGES FOR RAILWAY WHEEL MACHINING

CARTRIDGE	1	2	-	3	4	5	6	7
	KT	P		L	A	N	L	19
HOLDERS	8			6	9	10	11	12
	DKT			R	50	55	X	X

1 Cartridge	2 Clamping system	3 Insert shape	4 Tool style – cutting edge angle
5 Clearance angle	P	C S L	A F
N $\alpha_n=0^\circ$	6 Direction of cut		7 Cutting edge length
	R	L	

8 Cartridge holder	9 Shank height (mm)
	50 55
11 Total length	10 Shank width (mm)
X	50 55

12 Type of machine					
A1	Hegenscheidt	1 cartridge in the holder	C1	Rafamet UBB 112/2	1 cartridge in the holder
A2	Hegenscheidt	2 cartridges in the holder	C2	Rafamet UBB 112/2	2 cartridges in the holder
B1	Rafamet UDA 125N	1 cartridge in the holder	D1	Rafamet UBB 112	1 cartridge in the holder
B2	Rafamet UDA 125N	2 cartridges in the holder	D2	Rafamet UBB 112	2 cartridges in the holder
4065X-C	Talgo	2 CNMX inserts in the holder	4065X-S	Talgo	2 SNMX inserts in the holder
4065X+KTP	Talgo	2 cartridges in the holder	5556+KTP	Talgo	2 cartridges in the holder

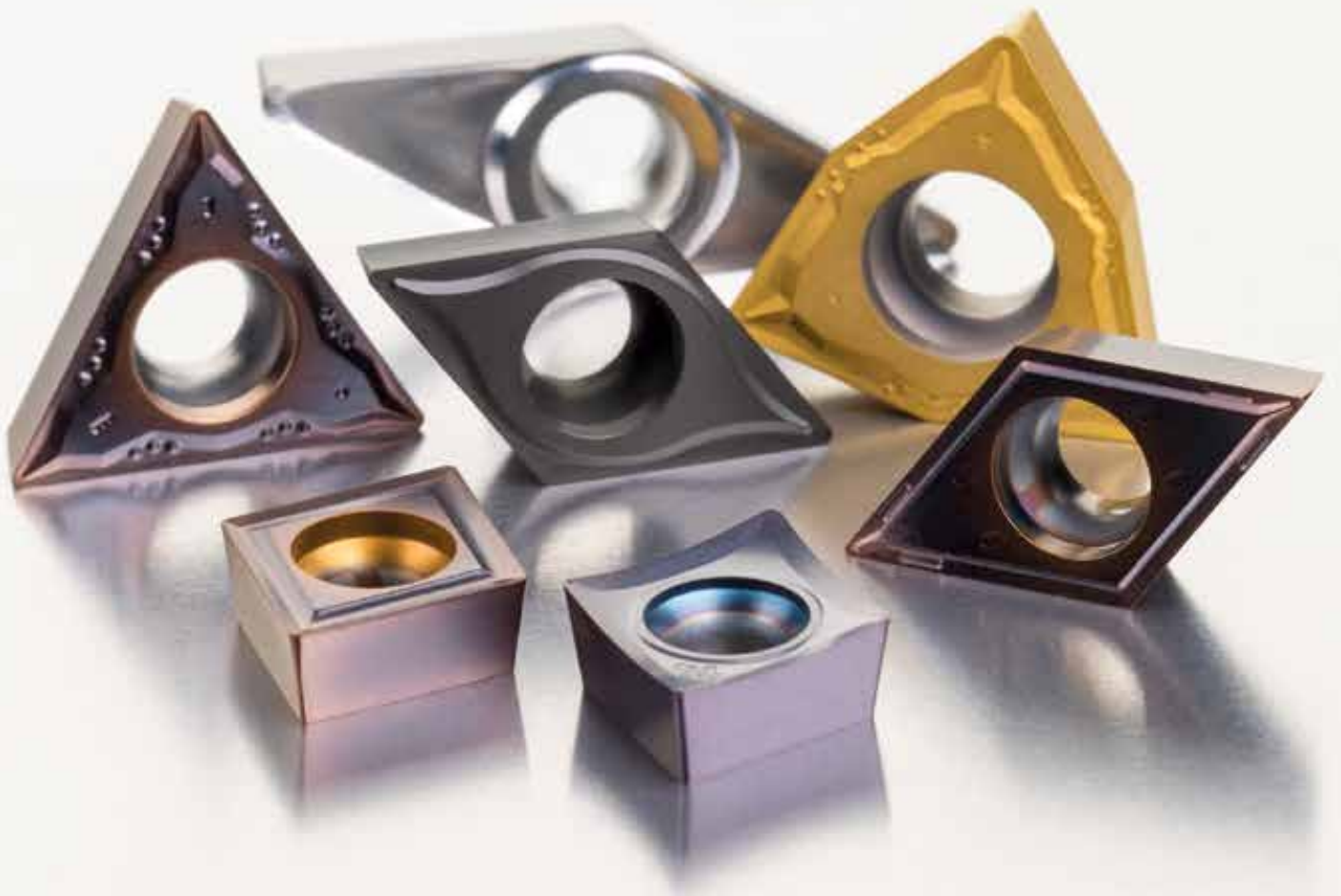

POSITIVE INSERTS



OP

06

CARBIDE INSERTS

OPCN



90



OPCN 06



	IC (mm)	L (mm)	S (mm)
1606	15.875	6.576	3.18

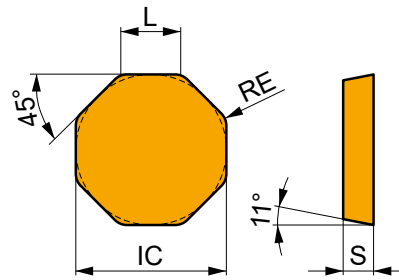

Suitability and starting values for cutting speed (vc), feed (f) and depth of cut (ap). Refer to our Machining Calculator app for further calculations.

Product	RE (mm)	P			M			K			N			S			H		
		vc (m/min)	f (mm/rev)	ap (mm)	vc (m/min)	f (mm/rev)	ap (mm)	vc (m/min)	f (mm/rev)	ap (mm)	vc (m/min)	f (mm/rev)	ap (mm)	vc (m/min)	f (mm/rev)	ap (mm)	vc (m/min)	f (mm/rev)	ap (mm)

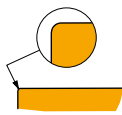

Geometry for finish to medium machining, continuous to interrupted cuts.

OPCN 06-2081000*	T9315	1.7	95	0.60	2.0	65	0.60	2.0	90	0.60	2.0	-	-	-	-	-	-	-
S-OPCN06-000720*	T8330	1.3	105	0.60	1.5	70	0.60	1.5	100	0.60	1.5	-	-	-	-	-	-	-
S-OPCN06-001355*	T8330	1.3	105	0.60	2.0	70	0.60	2.0	100	0.60	2.0	-	-	-	-	-	-	-
	T9315	1.3	95	0.60	2.0	65	0.60	2.0	90	0.60	2.0	-	-	-	-	-	-	-

* Special items



RC

06/ 08/ 10/ 12/ 16/ 20/ 25/ 30/ 32

CARBIDE INSERTS

RCMH	RCMT	RCMX	RCUM
92	93	95	97

MATCH THE RIGHT SIZE (example)

Insert	Tool Holder
RCMT 1204MOE-RM3	SRDCN 3225 P 12-M

PRDCN EXT		PRSC(RL) EXT		SRDCN EXT		SRSC(RL) EXT	
	<p>RC..</p> <p>16 20 25 32</p>		<p>RC..</p> <p>16 20 25</p>		<p>RC..</p> <p>06 08 10 12 16</p>		<p>RC..</p> <p>06 08 10 12 16</p>
32x25 50x50	98 92-97	32x25 40x40	99 92-97	12x12 32x25	100 92-97	12x12 32x25	101 92-97
C.-SRDCN EXT		KHP-RSCR/L + DKH(RL)					
	<p>RC..</p> <p>10 12</p>		<p>RC..</p> <p>20 25 32</p>				
C4 C5	102 92-97	40x50 60x80	103 92-97				



RCMH



	INSD (mm)	D1 (mm)	S (mm)
3209	32.000	10.50	9.53
000403	32.000	10.50	9.53
001450	32.000	10.50	9.53

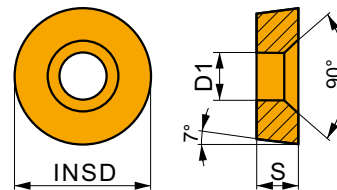

Suitability and starting values for cutting speed (vc), feed (f) and depth of cut (ap). Refer to our Machining Calculator app for further calculations.

Product	RE (mm)	P			M			K			N			S			H		
		vc (m/min)	f (mm/rev)	ap (mm)	vc (m/min)	f (mm/rev)	ap (mm)	vc (m/min)	f (mm/rev)	ap (mm)	vc (m/min)	f (mm/rev)	ap (mm)	vc (m/min)	f (mm/rev)	ap (mm)	vc (m/min)	f (mm/rev)	ap (mm)

RM2 geometry for semi-rough to rough machining, and continuous to interrupted cuts.

RCMH 3209MO-RM2*	T5315	-	95	1.00	4.5	-	-	-	90	1.00	4.5	-	-	-	-	-	-	-	-
S-RCMH3209MO-RM2*	T5305	-	95	1.00	4.5	-	-	-	95	1.00	4.5	-	-	-	-	-	-	-	-
S-RCMH3209MO-RM2*	T9210	-	90	1.00	4.5	-	-	-	85	1.00	4.5	-	-	-	-	-	-	-	-

RR2 geometry for heavy rough machining, and continuous to interrupted cuts.

RCMH 3209MO-RR2*	6630	-	70	1.00	4.5	-	-	-	65	1.00	4.5	-	-	-	-	-	-	-	-
------------------	------	---	----	------	-----	---	---	---	----	------	-----	---	---	---	---	---	---	---	---

000403 geometry for semi-rough to heavy-rough machining, and continuous to interrupted cuts.

S-RCMH32-000403*	T9315	-	85	1.00	4.5	-	-	-	85	1.00	4.5	-	-	-	-	-	-	-	-
	T9325	-	75	1.00	4.5	-	-	-	70	1.00	4.5	-	-	-	-	-	-	-	-

001450 geometry for roughing to heavy-rough machining, and continuous to interrupted cuts.

S-RCMH32-001450*	T9310	-	60	1.40	4.5	-	-	-	55	1.40	4.5	-	-	-	-	-	-	-	-
------------------	-------	---	----	------	-----	---	---	---	----	------	-----	---	---	---	---	---	---	---	---

* Special items



RCMT



	INSD (mm)	D1 (mm)	S (mm)
0602	6.000	2.80	2.38
0803	8.000	3.40	3.18
10T3	10.000	4.40	3.97
1204	12.000	4.40	4.76
1606	16.000	5.50	6.35
2006	20.000	6.50	6.35
2507	25.000	8.60	7.94
3009	30.000	10.00	9.53

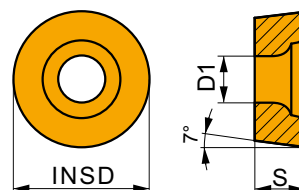

Suitability and starting values for cutting speed (vc), feed (f) and depth of cut (ap). Refer to our Machining Calculator app for further calculations.

Product	RE (mm)	P			M			K			N			S			H		
		vc (m/min)	f (mm/rev)	ap (mm)	vc (m/min)	f (mm/rev)	ap (mm)	vc (m/min)	f (mm/rev)	ap (mm)	vc (m/min)	f (mm/rev)	ap (mm)	vc (m/min)	f (mm/rev)	ap (mm)	vc (m/min)	f (mm/rev)	ap (mm)

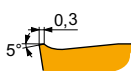

Geometry 37 for semi-rough to heavy-rough machining, and continuous to interrupted cuts.

RCMT 1606M05-37	T9315	-	█	165	0.60	3.0	█	-	-	-	█	155	0.60	3.0	█	-	-	-	-	-	-
	T9325	-	█	145	0.60	3.0	█	-	-	-	█	135	0.60	3.0	█	-	-	-	-	-	-

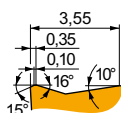

Geometry 371 for semi-rough to heavy-rough machining, and continuous to interrupted cuts.

RCMT 2006M05-371	T9315	-	█	145	0.80	3.0	█	-	-	-	█	135	0.80	3.0	█	-	-	-	-	-
	T9325	-	█	125	0.80	3.0	█	-	-	-	█	115	0.80	3.0	█	-	-	-	-	-

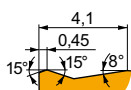

Geometry 372 for semi-rough to heavy-rough machining, continuous to interrupted cuts.

RCMT 2507M05-372	T9325	-	█	90	0.80	3.0	█	-	-	-	█	85	0.80	3.0	█	-	-	-	-	-
------------------	-------	---	---	----	------	-----	---	---	---	---	---	----	------	-----	---	---	---	---	---	---

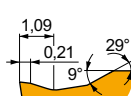

FM geometry for finish to semi-rough machining, and continuous to slightly interrupted cuts.

RCMT 0602M0E-FM	T7325	-	█	215	0.45	1.2	█	165	0.41	1.2	█	-	-	-	█	-	-	-	-	-
	T8430	-	█	200	0.45	1.2	█	110	0.41	1.2	█	165	0.45	1.2	█	555	0.54	1.2	-	-
	T9315	-	█	260	0.45	1.2	█	-	-	-	█	245	0.45	1.2	█	-	-	-	-	-
	T9325	-	█	235	0.45	1.2	█	140	0.41	1.2	█	220	0.45	1.2	█	-	-	-	-	-
RCMT 0803M0E-FM	T7325	-	█	190	0.60	1.6	█	145	0.54	1.6	█	-	-	-	█	-	-	-	-	-
	T8430	-	█	175	0.60	1.6	█	95	0.54	1.6	█	140	0.60	1.6	█	480	0.72	1.6	-	-
	T9315	-	█	225	0.60	1.6	█	-	-	-	█	210	0.60	1.6	█	-	-	-	-	-
	T9325	-	█	200	0.60	1.6	█	120	0.54	1.6	█	190	0.60	1.6	█	-	-	-	-	-
RCMT 10T3M0E-FM	T7325	-	█	185	0.65	1.7	█	140	0.59	1.7	█	-	-	-	█	-	-	-	-	-
	T8430	-	█	170	0.65	1.7	█	90	0.59	1.7	█	135	0.65	1.7	█	465	0.78	1.7	-	-
	T9315	-	█	220	0.65	1.7	█	-	-	-	█	205	0.65	1.7	█	-	-	-	-	-
	T9325	-	█	195	0.65	1.7	█	115	0.59	1.7	█	185	0.65	1.7	█	-	-	-	-	-
RCMT 1204M0E-FM	T7325	-	█	175	0.70	1.8	█	135	0.63	1.8	█	-	-	-	█	-	-	-	-	-
	T8430	-	█	155	0.70	1.8	█	85	0.63	1.8	█	130	0.70	1.8	█	435	0.84	1.8	-	-
	T9315	-	█	205	0.70	1.8	█	-	-	-	█	190	0.70	1.8	█	-	-	-	-	-
	T9325	-	█	190	0.70	1.8	█	110	0.63	1.8	█	180	0.70	1.8	█	-	-	-	-	-



Suitability and starting values for cutting speed (vc), feed (f) and depth of cut (ap). Refer to our Machining Calculator app for further calculations.

Product	RE (mm)	P			M			K			N			S			H		
		vc (m/min)	f (mm/rev)	ap (mm)	vc (m/min)	f (mm/rev)	ap (mm)	vc (m/min)	f (mm/rev)	ap (mm)	vc (m/min)	f (mm/rev)	ap (mm)	vc (m/min)	f (mm/rev)	ap (mm)	vc (m/min)	f (mm/rev)	ap (mm)

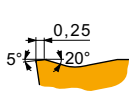

RM3 geometry for semi-rough to rough machining, and continuous to interrupted cuts.

RCMT 0803MOE-RR3	T9315	—	■	225	0.50	1.3	—	—	—	■	210	0.50	1.3	—	—	—	—	—	—	■	45	0.25	0.5
	RCMT 1204MOE-RR3	H07	—	—	—	—	■	65	0.54	1.8	■	105	0.60	1.8	—	—	—	—	—	—	—	—	—
RCMT 1606MOE-RR3	T7325	—	■	165	0.60	1.8	■	125	0.54	1.8	—	—	—	—	—	—	—	—	—	—	—	—	
	T8430	—	■	150	0.60	1.8	■	80	0.54	1.8	■	125	0.60	1.8	—	—	—	—	—	■	25	0.30	0.8
	T9315	—	■	205	0.60	1.8	—	—	—	—	■	190	0.60	1.8	—	—	—	—	—	■	40	0.30	0.8
	T7325	—	■	160	0.65	2.0	■	120	0.59	2.0	—	—	—	—	—	—	—	—	—	—	—	—	
	T8430	—	■	145	0.65	2.0	■	80	0.59	2.0	■	120	0.65	2.0	—	—	—	—	—	■	25	0.33	1.1
	T9315	—	■	195	0.65	2.0	—	—	—	—	■	185	0.65	2.0	—	—	—	—	—	■	35	0.33	1.1

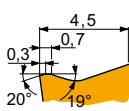

RR4 geometry for heavy rough machining, and continuous to heavy interrupted cuts.

RCMT 3009MO-RR4	T9310	—	■	90	1.10	4.0	—	—	—	■	85	1.10	4.0	—	—	—	—	—	—	—	—	—
	T9315	—	■	85	1.10	4.0	—	—	—	■	80	1.10	4.0	—	—	—	—	—	—	—	—	—

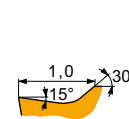

UR geometry for fine to finish machining, and continuous to slightly interrupted cuts.

RCMT 0602MOE-UR	T6310	—	■	170	0.40	1.2	■	120	0.36	1.2	■	135	0.40	1.2	—	—	—	—	—	—	—	—
	T8430	—	■	180	0.40	1.2	■	95	0.36	1.2	■	145	0.40	1.2	—	—	—	—	—	—	—	—
	T9315	—	■	240	0.40	1.2	—	—	—	—	■	225	0.40	1.2	—	—	—	—	—	—	—	—
	T9325	—	■	215	0.40	1.2	■	125	0.36	1.2	■	200	0.40	1.2	—	—	—	—	—	—	—	—
RCMT 0803MOE-UR	T6310	—	■	160	0.45	1.6	■	115	0.41	1.6	■	125	0.45	1.6	—	—	—	—	—	—	—	—
	T7325	—	■	180	0.45	1.6	■	140	0.41	1.6	—	—	—	—	—	—	—	—	—	—	—	
	T8430	—	■	170	0.45	1.6	■	90	0.41	1.6	■	135	0.45	1.6	—	—	—	—	—	—	—	
	T9315	—	■	220	0.45	1.6	—	—	—	—	■	205	0.45	1.6	—	—	—	—	—	—	—	—
	T9325	—	■	200	0.45	1.6	■	120	0.41	1.6	■	190	0.45	1.6	—	—	—	—	—	—	—	—
RCMT 10T3MOE-UR	T6310	—	■	160	0.50	1.4	■	115	0.45	1.4	■	125	0.50	1.4	—	—	—	—	—	—	—	—
	T7325	—	■	175	0.50	1.4	■	135	0.45	1.4	—	—	—	—	—	—	—	—	—	—	—	
	T8430	—	■	165	0.50	1.4	■	90	0.45	1.4	■	135	0.50	1.4	—	—	—	—	—	—	—	
	T9315	—	■	215	0.50	1.4	—	—	—	—	■	200	0.50	1.4	—	—	—	—	—	—	—	—
	T9325	—	■	190	0.50	1.4	■	110	0.45	1.4	■	180	0.50	1.4	—	—	—	—	—	—	—	—
RCMT 1204MOE-UR	T6310	—	■	150	0.55	1.8	■	105	0.50	1.8	■	120	0.55	1.8	—	—	—	—	—	—	—	—
	T8430	—	■	145	0.55	1.8	■	80	0.50	1.8	■	120	0.55	1.8	—	—	—	—	—	—	—	
	T9315	—	■	200	0.55	1.8	—	—	—	—	■	190	0.55	1.8	—	—	—	—	—	—	—	
	T9325	—	■	180	0.55	1.8	■	105	0.50	1.8	■	170	0.55	1.8	—	—	—	—	—	—	—	









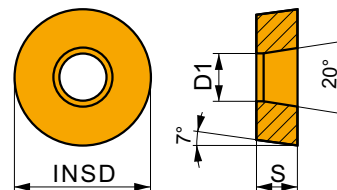



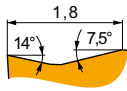



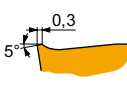



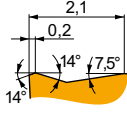

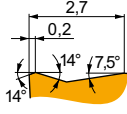

RCMX

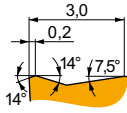

	INSD (mm)	D1 (mm)	S (mm)
1003	10.000	3.60	3.18
1204	12.000	4.20	4.76
1606	16.000	5.20	6.35
2006	20.000	6.50	6.35
2507	25.000	7.20	7.94
3209	32.000	9.50	9.53
000108	32.000	9.50	9.53

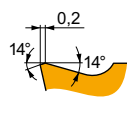

Suitability and starting values for cutting speed (vc), feed (f) and depth of cut (ap). Refer to our Machining Calculator app for further calculations.

Product	RE (mm)	P			M			K			N			S			H			
		vc (m/min)	f (mm/rev)	ap (mm)	vc (m/min)	f (mm/rev)	ap (mm)	vc (m/min)	f (mm/rev)	ap (mm)	vc (m/min)	f (mm/rev)	ap (mm)	vc (m/min)	f (mm/rev)	ap (mm)	vc (m/min)	f (mm/rev)	ap (mm)	
	T9325	-																		
			165	0.50	2.0	95	0.45	2.0	155	0.50	2.0	-	-	-	-	-	-	-	-	-
RCMX 1003MOS-31	T9325	-	165	0.50	2.0	95	0.45	2.0	155	0.50	2.0	-	-	-	-	-	-	-		
	T9315	-																		
			145	0.60	3.0	-	-	-	135	0.60	3.0	-	-	-	-	-	-	-	-	-
RCMX 1606MOS-37	T9315	-	165	0.60	3.0	-	-	-	155	0.60	3.0	-	-	-	-	-	-	-		
RCMX 2006MOS-37	6630	-	145	0.60	3.0	-	-	-	135	0.60	3.0	-	-	-	-	-	-	-		
RCMX 2507MOS-37	6630	-	135	0.60	3.0	-	-	-	125	0.60	3.0	-	-	-	-	-	-	-		
RCMX 2507MOS-37	6630	-	90	0.60	3.0	-	-	-	85	0.60	3.0	-	-	-	-	-	-	-		
	T9315	-																		
			130	1.00	3.0	-	-	-	120	1.00	3.0	-	-	-	-	-	-	-	-	-
RCMX 1204MOS-321	T9315	-	130	1.00	3.0	-	-	-	120	1.00	3.0	-	-	-	-	-	-	-		
	T9325	-	120	1.00	3.0	-	-	-	110	1.00	3.0	-	-	-	-	-	-	-		
	6630	-																		
			100	1.20	3.5	-	-	-	95	1.20	3.5	-	-	-	-	-	-	-	-	-
RCMX 1606MOS-331	6630	-	100	1.20	3.5	-	-	-	95	1.20	3.5	-	-	-	-	-	-	-		
	T9315	-	120	1.20	3.5	-	-	-	110	1.20	3.5	-	-	-	-	-	-	-		
	T9325	-	105	1.20	3.5	-	-	-	95	1.20	3.5	-	-	-	-	-	-	-		
	T9335	-	110	0.80	3.5	-	-	-	-	-	-	-	-	-	-	-	-	-		
	6630	-																		
			105	1.00	3.5	-	-	-	95	1.00	3.5	-	-	-	-	-	-	-	-	-
RCMX 2006MOS-341	6630	-	105	1.00	3.5	-	-	-	95	1.00	3.5	-	-	-	-	-	-	-		
	6640	-	90	1.00	3.5	-	-	-	85	1.00	3.5	-	-	-	-	-	-	-		
	6630	-																		
			70	1.00	3.5	-	-	-	65	1.00	3.5	-	-	-	-	-	-	-	-	-
RCMX 2507MOS-351	6630	-	70	1.00	3.5	-	-	-	65	1.00	3.5	-	-	-	-	-	-	-		
	6640	-	60	1.00	3.5	-	-	-	55	1.00	3.5	-	-	-	-	-	-	-		



Suitability and starting values for cutting speed (vc), feed (f) and depth of cut (ap). Refer to our Machining Calculator app for further calculations.

Product	RE (mm)	P			M			K			N			S			H		
		vc (m/min)	f (mm/rev)	ap (mm)	vc (m/min)	f (mm/rev)	ap (mm)	vc (m/min)	f (mm/rev)	ap (mm)	vc (m/min)	f (mm/rev)	ap (mm)	vc (m/min)	f (mm/rev)	ap (mm)	vc (m/min)	f (mm/rev)	ap (mm)

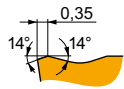

Geometry 361 for rough to heavy-rough machining and continuous to heavy interrupted cuts.

RCMX 3209M0S-361	6640	-	50	1.40	4.5	-	-	-	45	1.40	4.5	-	-	-	-	-	-	-	-
------------------	------	---	----	------	-----	---	---	---	----	------	-----	---	---	---	---	---	---	---	---

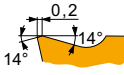

RF1 geometry for finish to semi-rough machining, and continuous to interrupted cuts.

RCMX 2006M0-RF1	T5305	-	105	0.80	3.5	-	-	-	95	0.80	3.5	-	-	-	-	-	-	-	-
	T9310	-	105	0.80	3.5	-	-	-	95	0.80	3.5	-	-	-	-	-	-	-	-
	T9315	-	100	0.80	3.5	-	-	-	95	0.80	3.5	-	-	-	-	-	-	-	-
	T9325	-	90	0.80	3.5	-	-	-	85	0.80	3.5	-	-	-	-	-	-	-	-
	T9335	-	110	0.80	3.5	-	-	-	-	-	-	-	-	-	-	-	-	-	-
RCMX 2507M0-RF1	T8345	-	45	1.00	3.5	-	-	-	40	1.00	3.5	-	-	-	-	-	-	-	-
	T9310	-	95	1.00	3.5	-	-	-	90	1.00	3.5	-	-	-	-	-	-	-	-
	T9315	-	90	1.00	3.5	-	-	-	85	1.00	3.5	-	-	-	-	-	-	-	-
	T9325	-	80	1.00	3.5	-	-	-	75	1.00	3.5	-	-	-	-	-	-	-	-
	T9335	-	65	1.00	3.5	-	-	-	-	-	-	-	-	-	-	-	-	-	-

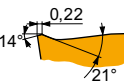

RM1 geometry for finish to rough machining, and continuous to interrupted cuts.

RCMX 2006M0-RM1	T9310	-	95	1.00	3.5	-	-	-	90	1.00	3.5	-	-	-	-	-	-	-	-
	T9315	-	90	1.00	3.5	-	-	-	85	1.00	3.5	-	-	-	-	-	-	-	-
	T9325	-	80	1.00	3.5	-	-	-	75	1.00	3.5	-	-	-	-	-	-	-	-
	T9335	-	125	0.60	3.0	-	-	-	-	-	-	-	-	-	-	-	-	-	-
RCMX 2507M0-RM1	T9310	-	95	1.00	3.5	-	-	-	90	1.00	3.5	-	-	-	-	-	-	-	-
	T9315	-	90	1.00	3.5	-	-	-	85	1.00	3.5	-	-	-	-	-	-	-	-
	T9325	-	80	1.00	3.5	-	-	-	75	1.00	3.5	-	-	-	-	-	-	-	-
	T9335	-	80	0.60	3.0	-	-	-	-	-	-	-	-	-	-	-	-	-	-

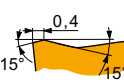

RM2 geometry for semi-rough to rough machining, and continuous to interrupted cuts.

RCMX 2507M0-RM2	T9310	-	90	1.10	3.5	-	-	-	85	1.10	3.5	-	-	-	-	-	-	-	-
	T9315	-	85	1.10	3.5	-	-	-	80	1.10	3.5	-	-	-	-	-	-	-	-
	T9325	-	75	1.10	3.5	-	-	-	70	1.10	3.5	-	-	-	-	-	-	-	-
RCMX 3209M0-RM2	T5315	-	95	1.00	4.5	-	-	-	90	1.00	4.5	-	-	-	-	-	-	-	-
	T9310	-	90	1.00	4.5	-	-	-	85	1.00	4.5	-	-	-	-	-	-	-	-
	T9315	-	85	1.00	4.5	-	-	-	80	1.00	4.5	-	-	-	-	-	-	-	-
	T9325	-	75	1.00	4.5	-	-	-	70	1.00	4.5	-	-	-	-	-	-	-	-
RCMX 3209M0-RM2	T9415	-	95	1.00	4.5	-	-	-	90	1.00	4.5	-	-	-	-	-	-	-	-

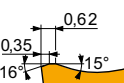

RR2 geometry for heavy rough machining, and continuous to interrupted cuts.

RCMX 3209M0-RR2	T9315	-	60	1.40	4.5	-	-	-	55	1.40	4.5	-	-	-	-	-	10	0.70	2.0
	T9316	-	60	1.40	4.5	-	-	-	55	1.40	4.5	-	-	-	-	-	-	-	-

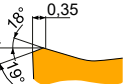

000108 geometry for semi-rough to heavy-rough machining, and continuous to interrupted cuts.

S-RCMX32-000108*	T9310	-	90	1.00	4.5	-	-	-	85	1.00	4.5	-	-	-	-	-	-	-	-
	T9315	-	85	1.00	4.5	-	-	-	80	1.00	4.5	-	-	-	-	-	-	-	-
	T9325	-	75	1.00	4.5	-	-	-	70	1.00	4.5	-	-	-	-	-	-	-	-



RCUM



	INSD	D1	S
	(mm)	(mm)	(mm)
3010	30.000	10.00	9.60

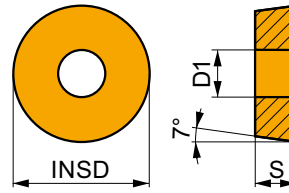

Suitability and starting values for cutting speed (vc), feed (f) and depth of cut (ap). Refer to our Machining Calculator app for further calculations.

Prodotto	RE (mm)	P			M			K			N			S			H		
		vc (m/min)	f (mm/rev)	ap (mm)	vc (m/min)	f (mm/rev)	ap (mm)	vc (m/min)	f (mm/rev)	ap (mm)	vc (m/min)	f (mm/rev)	ap (mm)	vc (m/min)	f (mm/rev)	ap (mm)	vc (m/min)	f (mm/rev)	ap (mm)

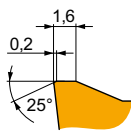

RR7 geometry for heavy-rough machining, and continuous to interrupted cuts.

RCUM 3010M0-RR7*	9215	-	70	1.00	4.0	-	-	-	65	1.00	4.0	-	-	-	-	-	-	-	-
	S30	-	40	0.85	4.0	-	-	-	-	-	-	-	-	-	-	-	-	-	-

* Special items



PRDCN EXT

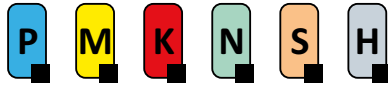

PRAMET

P



External Lever Lock Tool Holder for Round RC.. Insert

External neutral lever lock tool holder for positive RC.. 16 up to 32 inserts. Suited for external face and longitudinal turning without shoulder, copy turning up to 90°, taper and chamfer turning. Available with shank size 32x25 up to 50x50 mm. Body treated for longer tool life.

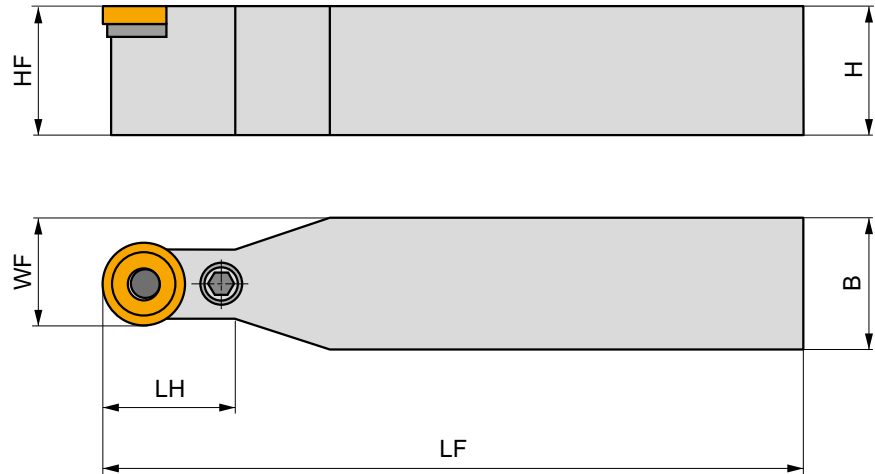
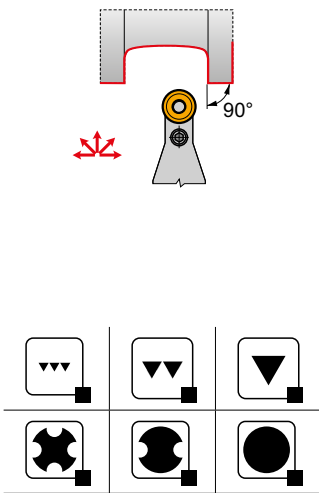

Product	H	B	HF	WF	LF	LH	LAMS	GAMO	kg		
	(mm)	(mm)	(mm)	(mm)	(mm)	(mm)	(°)	(°)			
PRDCN 3225 P 16	32	25	32	20.5	170	32	0	0	0.80	GI090	PRP70
PRDCN 3232 P 20	32	32	32	26	170	32	0	0	1.30	GI069	PRP90
PRDCN 4040 S 20	40	40	40	30	250	40	0	0	3.10	GI069	PRP90
PRDCN 4040 S 25	40	40	40	32.5	250	40	0	0	3.20	GI122	PRP80
PRDCN 5050 S 32	50	50	50	41	250	50	0	0	3.50	GI096	PRP32
PRDCN 5050 T 32	50	50	50	41	300	50	0	0	5.12	GI096	PRP32

GI069				RCMX 2006MO
GI090				RCMX 1606MO
GI096				RCMX 3209MO
GI122				RCMX 2507MO

PRP32	RCU 320600	PU 10	US 47	8.0	M 12x1	36	NT 08	MT 08	HXK 5
PRP70	RCU 160300	PU 07	US 36	6.0	M 8x1	26	NT 05	MT 05	HXK 4
PRP80	RCU 250600	PU 08	US 38	8.0	M 10x1	29	NT 06	MT 06	HXK 5
PRP90	RCU 200400	PU 09	US 36	6.0	M 8x1	26	NT 07	MT 07	HXK 4



PRSC(RL) EXT



PRAMET

P



External Lever Lock Tool Holder for Round RC.. Insert

External Right/Left hand lever lock tool holder for positive RC.. 16 up to 25 inserts. Suited for external face and longitudinal turning without shoulder, copy turning up to 27°, taper and chamfer turning, including face copy turning. Available with shank size 32x25 up to 40x40 mm. Body treated for longer tool life.

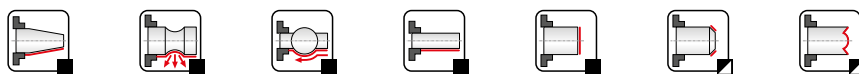
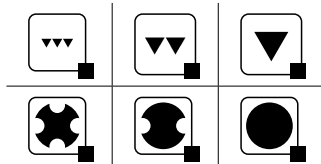
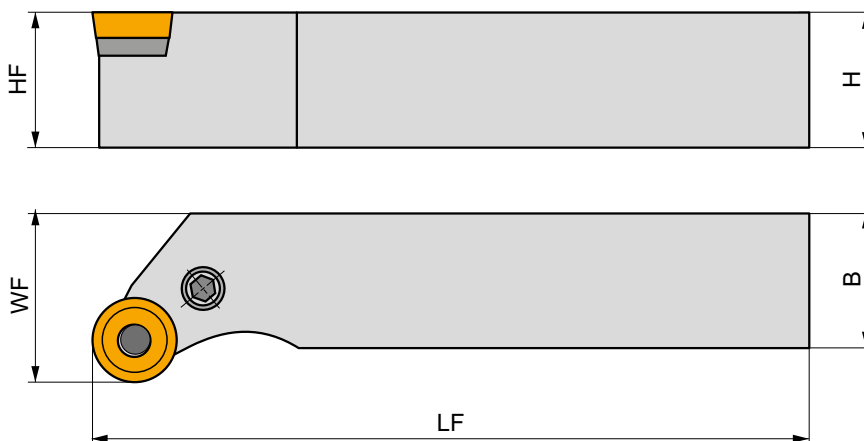
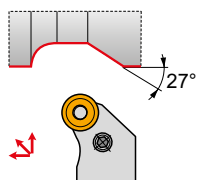

Product	H (mm)	B (mm)	HF (mm)	WF (mm)	LF (mm)	LAMS (°)	GAMO (°)	kg	GI069	GI090	GI122
R PRSCR 3225 P 16	32	25	32	32	170	0	0	0.90	GI090	PRP70	
PRSCR 4040 R 16	40	40	40	50	200	0	0	2.38	GI090	PRP70	
PRSCR 3232 P 20	32	32	32	40	170	0	0	1.40	GI069	PRP90	
PRSCR 4040 S 25	40	40	40	50	250	0	0	3.40	GI122	PRP80	
L PRSCL 3225 P 16	32	25	32	32	170	0	0	0.90	GI090	PRP70	
PRSCL 4040 R 16	40	40	40	50	200	0	0	2.38	GI090	PRP70	
PRSCL 3232 P 20	32	32	32	40	170	0	0	1.32	GI069	PRP90	
PRSCL 4040 S 25	40	40	40	50	250	0	0	3.40	GI122	PRP80	



GI069
GI090
GI122

RCMX 2006MO
RCMX 1606MO
RCMX 2507MO



PRP70
PRP80
PRP90

RCU 160300
RCU 250600
RCU 200400

PU 07
PU 08
PU 09

US 36
US 38
US 36

6.0
8.0
6.0

M 8x1
M 10x1
M 8x1

26
29
26

NT 05
NT 06
NT 07

MT 05
MT 06
MT 07

HXK 4
HXK 5
HXK 4



SRDCN EXT

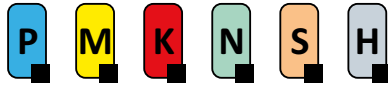

PRAMET

S



External Screw Lock Tool Holder for Round RC.. Insert

External neutral tool holder for screw type positive RC.. 06 up to 16 inserts. Suited for external face and longitudinal turning without shoulder, copy, taper and chamfer turning. Available with shank size 12x12 up to 32x25 mm. Body treated for longer tool life.

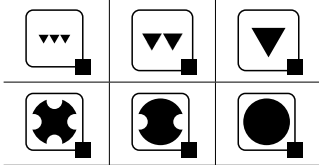
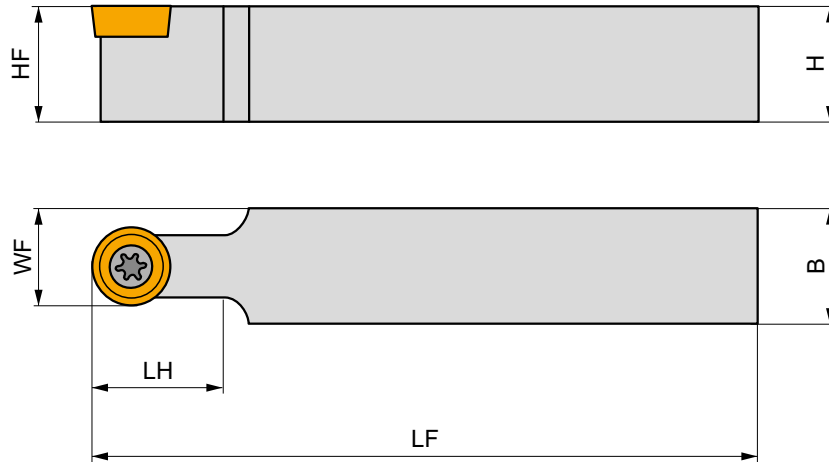
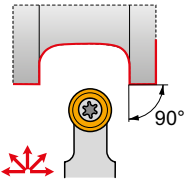

Product	H	B	HF	WF	LF	LH	LAMS	GAMO	kg		
	(mm)	(mm)	(mm)	(mm)	(mm)	(mm)	(°)	(°)			
SRDCN 1212 F 06	12	12	12	9	80	12	0	0	0.10	G1054	S01
SRDCN 1616 H 06	16	16	16	11	100	12	0	0	0.20	G1054	S01
SRDCN 2020 K 08	20	20	20	14	125	20	0	0	0.38	G1051	S03
SRDCN 2020 K 1003-M-A	20	20	20	15	125	25	0	0	0.40	G1064	SR10
N SRDCN 2020 K 10-M-A	20	20	20	15	125	25	0	0	0.40	G1013	SR10
SRDCN 2525 M 10-M-A	25	25	25	17.5	150	25	0	0	0.68	G1013	SR10
SRDCN 2525 M 12-M-A	25	25	25	18.5	150	30	0	0	0.68	G1014	SR12
SRDCN 3225 P 10-M	32	25	32	17.5	170	25	0	0	0.90	G1013	SR10
SRDCN 3225 P 12-M	32	25	32	18.5	170	30	0	0	0.90	G1014	SR12
SRDCN 3225 P 16-M	32	25	32	20.5	170	32	0	0	1.00	G1161	SR16



G1013	RC.. 10T3MO
G1014	RC.. 1204MO
G1051	RC.. 0803MO
G1054	RC.. 0602MO
G1064	RC.. 1003MO
G1161	RC.. 1606MO



S01	US 2506-T07P	0.9	M 2.5	6.3	-	-	FLAG T07P	-
S03	US 3007-T09P	2.0	M 3	7.3	-	-	FLAG T09P	-
SR10	US 3510-T15P	3.0	M 3.5	10.6	SRN 100300	MS 3510	FLAG T15P	HXK 3.5
SR12	US 3510-T15P	3.0	M 3.5	10.6	SRN 120300	MS 3510	FLAG T15P	HXK 3.5
SR16	US 5018-T20P	5.0	M 5	18.2	SRN 16T3MO	MS 5015	FLAG T20P	HXK 5



SRSC(RL) EXT



PRAMET

S



External Screw Lock Tool Holder for Round RC.. Insert

External Right/Left hand tool holder for screw type positive RC.. 06 up to 16 inserts. Suited for external face and longitudinal turning without shoulder, copy, taper and chamfer turning. Available with shank size 12x12 up to 32x25 mm. Body treated for longer tool life.

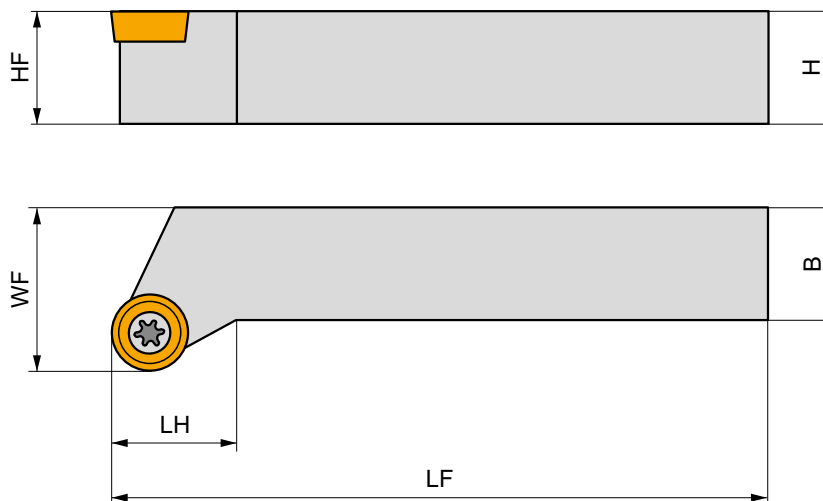
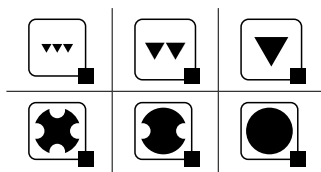
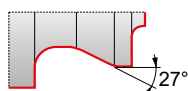

Product	H	B	HF	WF	LF	LH	LAMS	GAMO	kg			
	(mm)	(mm)	(mm)	(mm)	(mm)	(mm)	(°)	(°)				
R	SRSCR 1212 F 06	12	12	12	16	80	12	0	0	0.09	GI054	S01
	SRSCR 1616 H 06	16	16	16	20	100	12	0	0	0.22	GI054	S01
	SRSCR 2020 K 08	20	20	20	25	125	20	0	0	0.45	GI051	S03
	SRSCR 2020 K 10-M-A	20	20	20	25	125	20	0	0	0.45	GI013	SR10
	SRSCR 2525 M 10-M-A	25	25	25	32	150	20	0	0	0.75	GI013	SR10
	SRSCR 3225 P 10-M	32	25	32	32	170	20	0	0	1.06	GI013	SR10
	SRSCR 2525 M 12-M-A	25	25	25	32	150	20	0	0	0.75	GI014	SR12
	SRSCR 3225 P 12-M	32	25	32	32	170	20	0	0	1.07	GI014	SR12
L	SRSCR 3225 P 16-M	32	25	32	32	170	20	0	0	1.10	GI161	SR16
	SRSCL 1212 F 06	12	12	12	16	80	12	0	0	0.10	GI054	S01
	SRSCL 1616 H 06	16	16	16	20	100	12	0	0	0.22	GI054	S01
	SRSCL 2020 K 08	20	20	20	25	125	20	0	0	0.45	GI051	S03
	SRSCL 2020 K 10-M-A	20	20	20	25	125	20	0	0	0.45	GI013	SR10
	SRSCL 2525 M 10-M-A	25	25	25	32	150	20	0	0	0.75	GI013	SR10
	SRSCL 3225 P 10-M	32	25	32	32	170	20	0	0	1.06	GI013	SR10
	SRSCL 2525 M 12-M-A	25	25	25	32	150	20	0	0	0.75	GI014	SR12
SRSCL 3225 P 12-M	32	25	32	32	170	20	0	0	1.07	GI014	SR12	
SRSCL 3225 P 16-M	32	25	32	32	170	20	0	0	1.10	GI161	SR16	



GI013	RC.. 10T3MO
GI014	RC.. 1204MO
GI051	RC.. 0803MO
GI054	RC.. 0602MO
GI161	RC.. 1606MO



S01	US 2506-T07P	0.9	M 2.5	6.3	—	—	FLAGT07P	—
S03	US 3007-T09P	2.0	M 3	7.3	—	—	FLAGT09P	—
SR10	US 3510-T15P	3.0	M 3.5	10.6	SRN 100300	MS 3510	FLAGT15P	HXK 3.5
SR12	US 3510-T15P	3.0	M 3.5	10.6	SRN 120300	MS 3510	FLAGT15P	HXK 3.5
SR16	US 5018-T20P	5.0	M 5	18.2	SRN 16T3MO	MS 5015	FLAGT20P	HXK 5



C.-SRDCN EXT

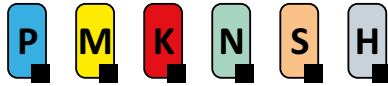

PRAMET

S



External PSC Quick Change Tool, Screw Lock for RC.. Insert

External neutral tool, through coolant, for screw type positive RC.. 10 up to 12 inserts. Suited for external face and longitudinal turning without shoulder, copy, taper and chamfer turning. Available with PSC (Polygon Shank Coupling) size C4 and C5. Body treated for longer tool life.

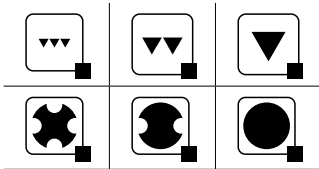
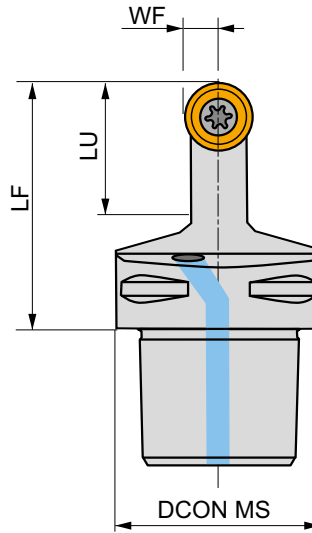
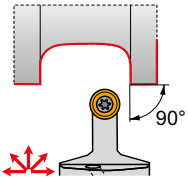

Product	DCON MS (mm)	WF (mm)	LF (mm)	LU (mm)	LAMS (°)	GAMO (°)		kg		
N C4-SRDCN-00050-12A	40	6	50	28	0	0	✓	0.32	GI014	C-SR12V-1
C5-SRDCN-00060-10A	50	5	60	25	0	0	✓	0.56	GI013	C-SR10V
C5-SRDCN-00060-12A	50	6	60	28	0	0	✓	0.56	GI014	C-SR12V-2

GI013	RC.. 10T3MO
GI014	RC.. 1204MO

C-SR10V	US 2010-T15P	3.0	M 3.5	10.1	SRS 110-01	MS 9001	FLAG T15P/3,5	CN 034-02
C-SR12V-1	US 2001-T15P	3.0	M 3.5	12.1	SRS 110-02	MS 9001	FLAG T15P/3,5	CN 034-01
C-SR12V-2	US 2001-T15P	3.0	M 3.5	12.1	SRS 110-02	MS 9001	FLAG T15P/3,5	CN 034-02



KHP-RSC(RL)



PRAMET

P



Modular KHP Lever Lock Turning Cartridge for RC.. Insert

Dovetailed Right/Left hand lever lock turning cartridge for mounting on DKH tool holder shank. Suited for heavy longitudinal turning without shoulder, face turning, taper and chamfer turning with positive RC.. 20 up to 32 inserts. Tool holder treated for longer tool life.

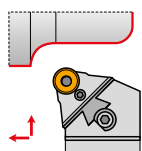

DKHR+KHP-RSCR

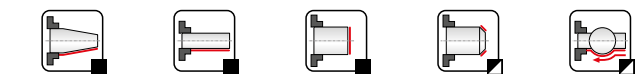
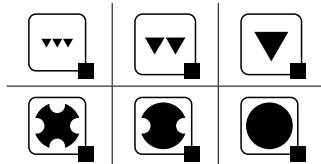
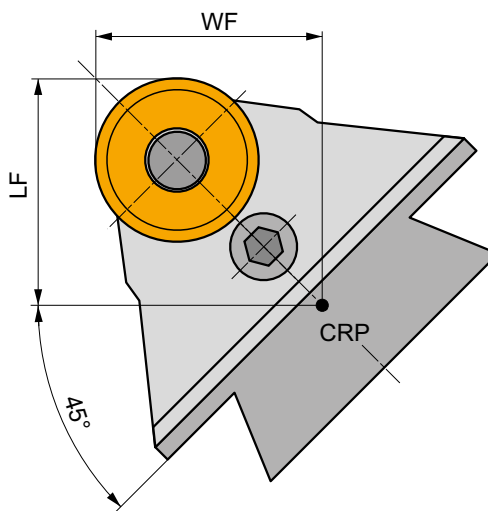

Product	WF	LF	LAMS	GAMO	kg		
	(mm)	(mm)	(°)	(°)			
R KHP-RSCR 20	35	45	0	0	1.30	GI069	PRP90
KHP-RSCR 25	35	45	0	0	1.30	GI122	PRP80
KHP-RSCR 32	35	45	0	0	1.30	GI096	PRP32
L KHP-RSCL 20	35	45	0	0	1.30	GI069	PRP90
KHP-RSCL 25	35	45	0	0	1.30	GI122	PRP80
KHP-RSCL 32	35	45	0	0	1.30	GI096	PRP32

GI069	RCMX 2006MO
GI096	RCMX 3209MO
GI122	RCMX 2507MO

PRP32	RCU 320600	PU 10	US 47	Nm	M 12x1	36	NT 08	MT 08	HXK 5
PRP80	RCU 250600	PU 08	US 38	8.0	M 10x1	29	NT 06	MT 06	HXK 5
PRP90	RCU 200400	PU 09	US 36	6.0	M 8x1	26	NT 07	MT 07	HXK 4



DKH(RL)



External Tool Holder Shank for KHP/KHS Heavy Turning Cartridges

Dovetailed Right/Left hand modular tool shank for KHP/KHS cartridges. Suited for heavy turning applications. Available with shank size 40x50 up to 60x80 mm. Body treated for longer tool life.

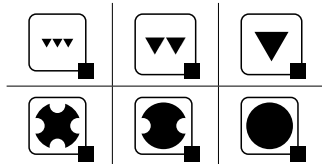
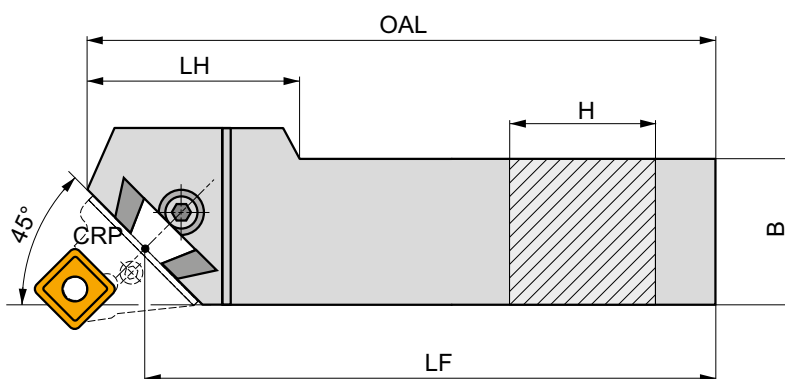
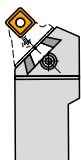

Product	H	B	LF	OAL	LH	kg		
	(mm)	(mm)	(mm)	(mm)	(mm)			
R DKHR 4050 V	40	50	400	425	100	7.10	GI098	DKH10
DKHR 5060 W	50	60	450	475	110	11.30	GI098	DKH10
DKHR 6080 W-A	60	80	450	485	90	19.65	GI098	DKH10
L DKHL 4050 V	40	50	400	425	100	7.10	GI098	DKH10
DKHL 5060 W	50	60	450	475	110	11.30	GI098	DKH10
DKHL 6080 W-A	60	80	450	485	90	19.65	GI098	DKH10

GI098	KHP	KHS
DKH10	SR 14	HXK 10



RP

27/ 30

CARBIDE INSERTS

RPUX

 106



RPUX



	INSD (mm)	D1 (mm)	S (mm)
2710	27.760	10.20	9.525
3010	30.800	10.00	9.525
1867000	30.800	10.00	9.525

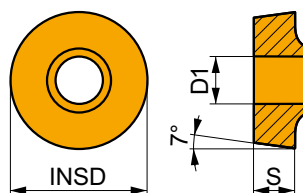

Suitability and starting values for cutting speed (vc), feed (f) and depth of cut (ap). Refer to our Machining Calculator app for further calculations.

Prodotto	RE (mm)	P			M			K			N			S			H				
		vc (m/min)	f (mm/rev)	ap (mm)	vc (m/min)	f (mm/rev)	ap (mm)	vc (m/min)	f (mm/rev)	ap (mm)	vc (m/min)	f (mm/rev)	ap (mm)	vc (m/min)	f (mm/rev)	ap (mm)	vc (m/min)	f (mm/rev)	ap (mm)		
 Geometry for heavy-rough machining, and continuous to interrupted cuts.		 	T9325	70	1.00	4.0	–	–	–	70	1.00	4.0	–	–	–	–	–	–	–	–	
			S30	40	0.85	4.0	–	–	–	–	–	–	–	–	–	–	–	–	–	–	–
 Geometry for heavy-rough machining, and continuous to interrupted cuts.		 	T9315	85	1.00	4.0	–	–	–	80	1.00	4.0	–	–	–	–	–	–	–	–	
			T9325	75	1.00	4.0	–	–	–	70	1.00	4.0	–	–	–	–	–	–	–	–	–
			S30	40	0.85	4.0	–	–	–	–	–	–	–	–	–	–	–	–	–	–	–
 Geometry for heavy-rough machining, and continuous to interrupted cuts.		 	6630	70	1.00	4.0	–	–	–	65	1.00	4.0	–	–	–	–	–	–	–	–	

* Special items



NEGATIVE INSERTS



BN

20

CARBIDE INSERTS

BNMX

 109



BNMX 20

	W1 (mm)	L (mm)	S (mm)
2015	12.000	20.00	15.00

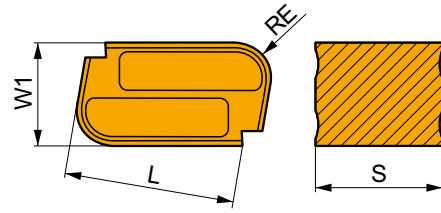

Suitability and starting values for cutting speed (vc), feed (f) and depth of cut (ap). Refer to our Machining Calculator app for further calculations.

Product	RE (mm)	P			M			K			N			S			H		
		vc (m/min)	f (mm/rev)	ap (mm)	vc (m/min)	f (mm/rev)	ap (mm)	vc (m/min)	f (mm/rev)	ap (mm)	vc (m/min)	f (mm/rev)	ap (mm)	vc (m/min)	f (mm/rev)	ap (mm)	vc (m/min)	f (mm/rev)	ap (mm)

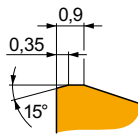

Geometry for rough to heavy-rough machining, and continuous to interrupted cuts.

BNMX 201540*	S30	4.0	40	0.85	4.0	-	-	-	-	-	-	-	-	-	-	-	-	-
---------------------	------------	-----	----	------	-----	---	---	---	---	---	---	---	---	---	---	---	---	---

* Special items



CN

19

CARBIDE INSERTS

CNMX 19



111

MATCH THE RIGHT SIZE (example)

Insert

CNMM 120412E-OR

Tool Holder

DCBNR 2525 M 12

DKT(RL)-A1 + KTP

		CN..
		19
		KTP-CAN(RL)
	50x55	
	112	111 119

DKT(RL)-A2 + KTP

		CN..
		19
		KTP-CAN(RL) KTP-CFN(RL)
	50x55	
	112	111 119 - 120

DKT(RL)-B1 + KTP

		CN..
		19
		KTP-CAN(RL)
	50x49.5	
	113	111 119

DKT(RL)-B2 + KTP

		CN..
		19
		KTP-CAN(RL) KTP-CFN(RL)
	50x49.5	
	113	111 119 - 120

DKT(RL)-C1 + KTP

		CN..
		19
		KTP-CAN(RL)
	55x55	
	114	111 119

DKT(RL)-C2 + KTP

		CN..
		19
		KTP-CAN(RL) KTP-CFN(RL)
	55x55 55x52	
	114	111 119 - 120

DKT(RL)-D1 + KTP

		CN..
		19
		KTP-CAN(RL)
	50x49.5	
	115	111 119

DKT(RL)-D2 + KTP

		CN..
		19
		KTP-CAN(RL) KTP-CFN(RL)
	50x49.5	
	115	111 119 - 120

S-DKT(RL)4065X-C

		CN..
		19
	45x65	
	116	111

S-DKT(RL)4065X + KTP

		CN..
		19
		KTP-CAN(RL) KTP-CFN(RL)
	45x65	
	117	111 119 - 120

S-DKT(RL)5556 + KTP

		CN..
		19
		KTP-CAN(RL) KTP-CFN(RL)
	56x55	
	118	111 119 - 120



CNMX 19



	IC (mm)	D1 (mm)	L (mm)	S (mm)
1907	19.050	7.75	19.30	7.94
1911	19.050	7.75	19.30	11.00

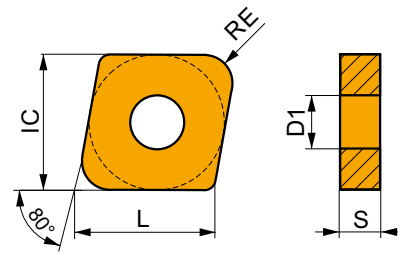

Suitability and starting values for cutting speed (vc), feed (f) and depth of cut (ap). Refer to our Machining Calculator app for further calculations.

Product	RE (mm)	P			M			K			N			S			H		
		vc (m/min)	f (mm/rev)	ap (mm)	vc (m/min)	f (mm/rev)	ap (mm)	vc (m/min)	f (mm/rev)	ap (mm)	vc (m/min)	f (mm/rev)	ap (mm)	vc (m/min)	f (mm/rev)	ap (mm)	vc (m/min)	f (mm/rev)	ap (mm)

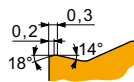

RF geometry for semi-rough to rough machining, and continuous to interrupted cuts.

CNMX 190740SN-RF	T5315	4.0	80	0.85	4.0	–	–	–	75	0.85	4.0	–	–	–	–	–	–	–	15	0.43	2.7
	T9315	4.0	80	0.85	4.0	–	–	–	75	0.85	4.0	–	–	–	–	–	–	–	15	0.43	2.7
S-CNMX 190740SN-RF*	T9325	4.0	70	0.85	4.0	–	–	–	65	0.85	4.0	–	–	–	–	–	–	–	–	–	–
CNMX 191140SN-RF	T9315	4.0	80	0.85	4.0	–	–	–	75	0.85	4.0	–	–	–	–	–	–	–	15	0.43	2.7

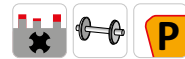
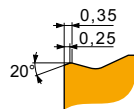

TF geometry for semi-rough to rough machining, and continuous to interrupted cuts.

CNMX 191140SN-TF	T9310	4.0	85	0.80	4.5	–	–	–	80	0.80	4.5	–	–	–	–	–	–	–	15	0.40	2.7
	T9315	4.0	80	0.80	4.5	–	–	–	75	0.80	4.5	–	–	–	–	–	–	–	15	0.40	2.7
	T9325	4.0	70	0.80	4.5	–	–	–	65	0.80	4.5	–	–	–	–	–	–	–	–	–	–

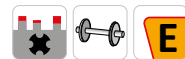
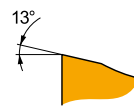

TF1 geometry for finish to semi-rough machining, continuous to interrupted cuts.

S-CNMX 191140SN-TF1*	T9315	4.0	80	0.85	4.0	–	–	–	75	0.85	2.0	–	–	–	–	–	–	–	15	0.40	1.5
----------------------	-------	-----	----	------	-----	---	---	---	----	------	-----	---	---	---	---	---	---	---	----	------	-----

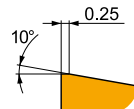

TF2 geometry for finish to semi-rough machining, continuous to interrupted cuts.

S-CNMX 191140SN-TF2*	T9315	4.0	80	0.85	4.0	–	–	–	75	0.85	2.0	–	–	–	–	–	–	–	15	0.40	1.5
----------------------	-------	-----	----	------	-----	---	---	---	----	------	-----	---	---	---	---	---	---	---	----	------	-----

* Special items



DKT(RL)-A



PRAMET

Basic R/L handed tool shank for KTP cartridge heads.

Suited for railway wheels returning. Available in shank size 50x55 mm. Suited for Hegenscheidt machine tools. Body treated for longer tool life.

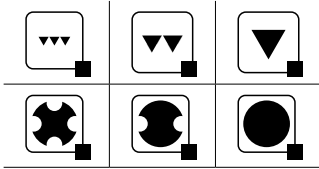
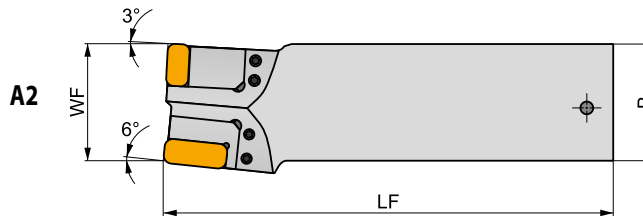
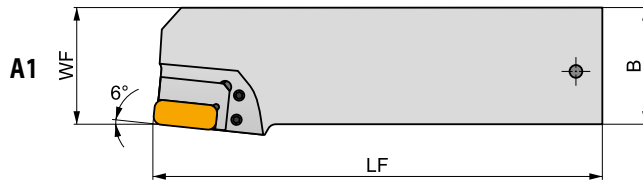
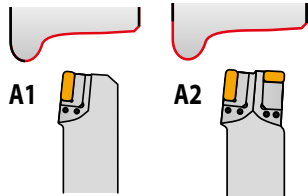

Product	H	B	LF	HF	WF	LAMS	GAMO	kg	G188	G189	G1391
	(mm)	(mm)	(mm)	(mm)	(mm)	(°)	(°)				
R DKTR 5055 X A1	50	55	210	44	55	-6	-6	3.70	G189	DKT	
DKTR 5055 X A2	50	55	210	44	55	-6	-6	3.70	G1391	DKT	
L DKTL 5055 X A1	50	55	210	44	55	-6	-6	3.82	G188	DKT	
DKTL 5055 X A2	50	55	210	44	55	-6	-6	3.78	G1390	DKT	

G188	KTP-LANL 19	KTP-LANL 30	KTP-SANL 19	KTP-CANL 19xx	-	-	-	-
G189	KTP-LANR 19	KTP-LANR 30	KTP-SANR 19	KTP-CANR 19xx	-	-	-	-
G1390	KTP-LANL 19	KTP-LANL 30	KTP-SANL 19	KTP-CANL 19xx	KTP-LFNR 19	KTP-SFNR 19	KTP-CFNR 19	
G1391	KTP-LANR 19	KTP-LANR 30	KTP-SANR 19	KTP-CANR 19xx	KTP-LFNL 19	KTP-SFNL 19	KTP-CFNL 19	

DKT	USS 0617	HXK 3



DKT(RL)-B



Basic R/L handed tool shank for KTP cartridge heads.

Suited for railway wheels returning. Available in shank size 50x49.5 mm. Suited for Rafamet UDA 125N machine tools. Body treated for longer tool life.

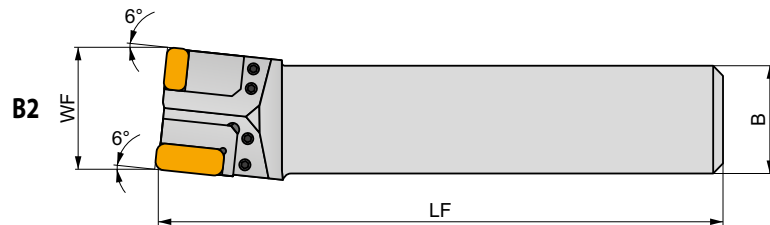
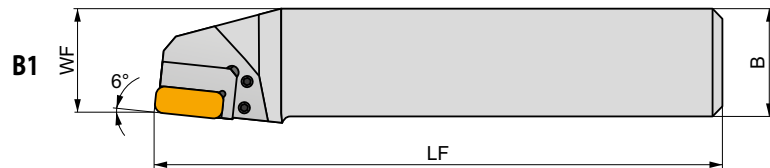
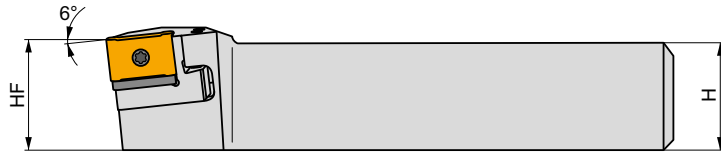
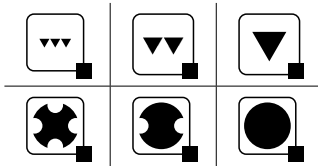
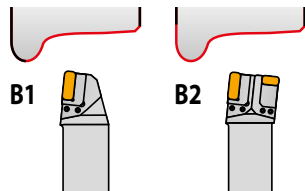

Product	H (mm)	B (mm)	LF (mm)	HF (mm)	WF (mm)	LAMS (°)	GAMO (°)	kg	GI	DKT
R DKTR 5050 X B1*	50	49.5	261	50	47	-6	-6	4.00	GI189	DKT
DKTR 5050 X B2*	50	49.5	261	50	55	-6	-6	4.00	GI391	DKT
L DKTL 5050 X B1*	50	49.5	261	50	47	-6	-6	4.00	GI188	DKT
DKTL 5050 X B2*	50	49.5	261	50	55	-6	-6	4.00	GI390	DKT

GI	KTP-LANL	KTP-LANR	KTP-SANL	KTP-CANL	LAMS	GAMO	KTP-LFNR	KTP-SFNR	KTP-CFNR
GI188	KTP-LANL 19	KTP-LANL 30	KTP-SANL 19	KTP-CANL 19xx	-	-	-	-	-
GI189	KTP-LANR 19	KTP-LANR 30	KTP-SANR 19	KTP-CANR 19xx	-	-	-	-	-
GI390	KTP-LANL 19	KTP-LANL 30	KTP-SANL 19	KTP-CANL 19xx	KTP-LFNR 19	KTP-SFNR 19	KTP-LFNR 19	KTP-SFNR 19	KTP-CFNR 19
GI391	KTP-LANR 19	KTP-LANR 30	KTP-SANR 19	KTP-CANR 19xx	KTP-LFNL 19	KTP-SFNL 19	KTP-LFNL 19	KTP-SFNL 19	KTP-CFNL 19

DKT	USS 0617	HXK 3

* Special items



DKT(RL)-C



Basic R/L handed tool shank for KTP cartridge heads.

Suited for railway wheels returning. Available in shank size 55x55 mm and 55x52 mm. Suited for Rafamet UBB 112/2 machine tools. Body treated for longer tool life.

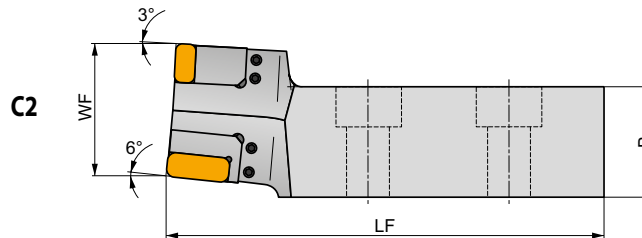
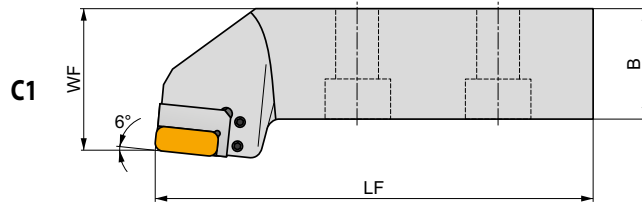
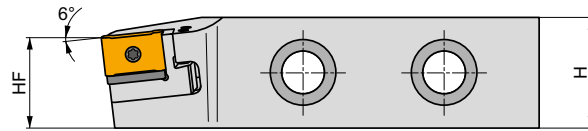
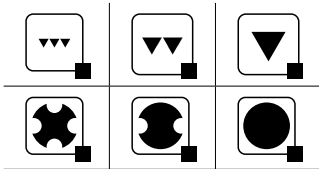
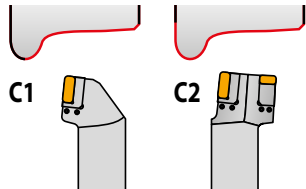

Product	H	B	LF	HF	WF	LAMS	GAMO	kg		
	(mm)	(mm)	(mm)	(mm)	(mm)	(°)	(°)			
R DKTR 5555 X C1*	55	55	217	44	70.00	-6	-6	4.10	G189	DKT
R DKTR 5555 X C2*	55	55	217	44	65.50	-6	-6	4.10	G1391	DKT
L DKTL 5555 X C1*	55	55	217	44	70.00	-6	-6	4.10	G188	DKT
L DKTL 5555 X C2*	55	55	217	44	65.50	-6	-6	4.10	G1390	DKT
R S-DKTR5552XC2-000231*	55	52	217	44	65.50	-6	-6	7.30	G1391	DKT
R S-DKTR5555XC2-000474*	55	55	217	44	70.00	-6	-6	7.70	G1391	DKT
L S-DKTL5552XC2-000230*	55	52	217	44	65.50	-6	-6	7.30	G1390	DKT
L S-DKTL5555XC2-000475*	55	55	217	44	70.00	-6	-6	7.70	G1390	DKT

G188	KTP-LANL 19	KTP-LANL 30	KTP-SANL 19	KTP-CANL 19xx	-	-	-	-
G189	KTP-LANR 19	KTP-LANR 30	KTP-SANR 19	KTP-CANR 19xx	-	-	-	-
G1390	KTP-LANL 19	KTP-LANL 30	KTP-SANL 19	KTP-CANL 19xx	KTP-LFNR 19	KTP-SFNR 19	KTP-CFNR 19	
G1391	KTP-LANR 19	KTP-LANR 30	KTP-SANR 19	KTP-CANR 19xx	KTP-LFNL 19	KTP-SFNL 19	KTP-CFNL 19	

DKT	USS 0617	HXK 3

* Special items



DKT(RL)-D



Basic R/L handed tool shank for KTP cartridge heads.

Suited for railway wheels returning. Available in shank size 50x49.5 mm. Suited for Rafamet UBB 112 machine tools. Body treated for longer tool life.

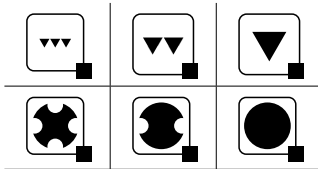
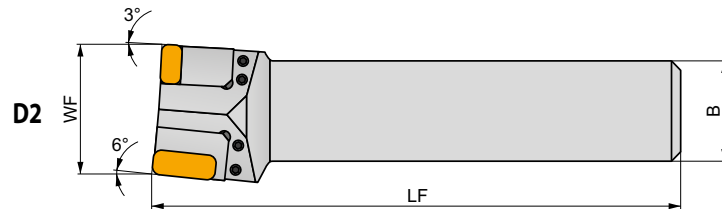
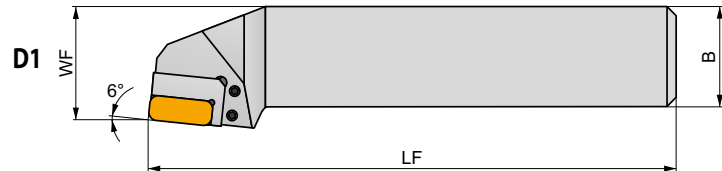
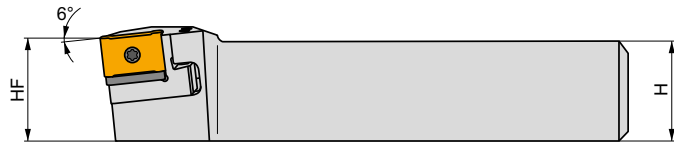
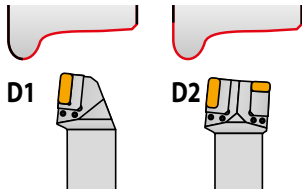

Product	H	B	LF	HF	WF	LAMS	GAMO	kg		
	(mm)	(mm)	(mm)	(mm)	(mm)	(°)	(°)			
R DKTR 5050 X D1*	50	49.5	262	50	55.50	-6	-6	4.20	G189	DKT
DKTR 5050 X D2*	50	49.5	262	50	63.00	-6	-6	4.20	G1391	DKT
L DKTL 5050 X D1*	50	49.5	262	50	55.50	-6	-6	4.20	G188	DKT
DKTL 5050 X D2*	50	49.5	262	50	63.00	-6	-6	4.20	G1390	DKT

G188	KTP-LANL 19	KTP-LANL 30	KTP-SANL 19	KTP-CANL 19xx	-	-	-	-
G189	KTP-LANR 19	KTP-LANR 30	KTP-SANR 19	KTP-CANR 19xx	-	-	-	-
G1390	KTP-LANL 19	KTP-LANL 30	KTP-SANL 19	KTP-CANL 19xx	KTP-LFNR 19	KTP-SFNR 19	KTP-CFNR 19	
G1391	KTP-LANR 19	KTP-LANR 30	KTP-SANR 19	KTP-CANR 19xx	KTP-LFNL 19	KTP-SFNL 19	KTP-CFNL 19	

DKT	USS 0617	HXK 3

* Special items



S-DKT(RL)4065X-C



Basic R/L handed tool shank for CNMX 19 inserts clamping.

Suited for renovation of railway wheels. Available in shank size 40x65 mm. Body treated for longer tool life.

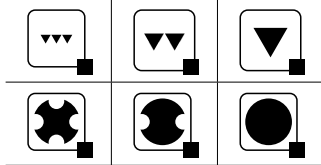
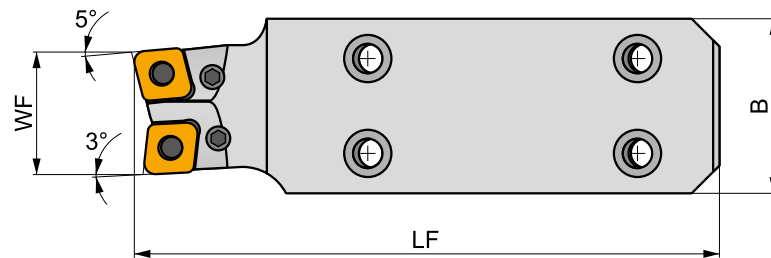
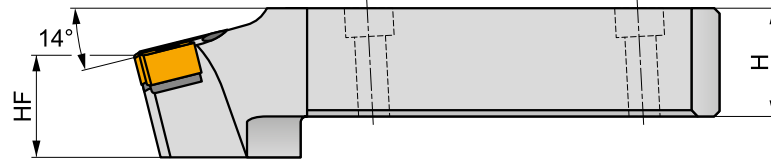
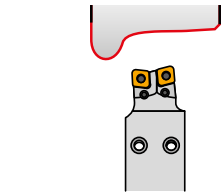

Product	H	B	LF	HF	WF	LAMS	GAMO	kg		
	(mm)	(mm)	(mm)	(mm)	(mm)	(°)	(°)			
R S-DKTR4065X-000243*	40	65	205.9	22.75	45.16	-14	-6	3.43	GI042	C1907
S-DKTR4065X-000378*	40	65	217	22	45	-14	-6	3.70	GI062	C1907
S-DKTR4065X-000437*	40	65	205.9	22.75	45.16	-14	-6	3.50	GI062	C1907
L S-DKTL4065X-000247*	40	65	205.9	22.75	45.16	-14	-6	3.43	GI042	C1907
S-DKTL4065X-000379*	40	65	217	22	45	-14	-6	3.70	GI062	C1907
S-DKTL4065X-000438*	40	65	205.9	22.75	45.16	-14	-6	3.50	GI062	C1907

GI042	CN..1907
GI062	CN..1911

C1907	CNX 19X340	PU 05	US 38	8,0	M10x1	29	NT 06	MT 06	HXK 4
C1911	CNX 19X340	PU 16	US 95	10,0	M10x1	30,5	NT 06	MT 06	HXK 4

* Special items



S-DKT(RL)4065X+KTP



Basic R/L handed tool shank for KTP cartridge heads or direct CNMX 19 or SNMX 19 inserts clamping.
 Suited for renovation of railway wheels. Available in shank size 40x65 mm. Body treated for longer tool life.

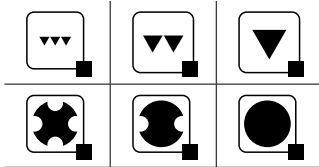
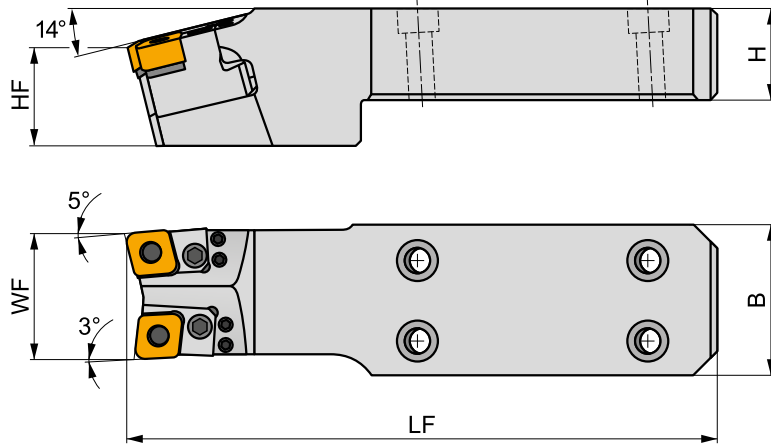
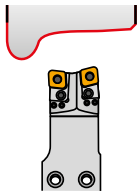

Product	H (mm)	B (mm)	LF (mm)	HF (mm)	WF (mm)	LAMS (°)	GAMO (°)	kg		
R S-DKTR4065X-000435*	40	65	255.9	22.75	54	-14	-6	4.60	GI391	DKT
L S-DKTL4065X-000436*	40	65	255.9	22.75	45.16	-14	-6	3.43	GI390	DKT

GI390	KTP-LANL 19	KTP-LANL 30	KTP-SANL 19	KTP-CANL 19xx	KTP-LFNR 19	KTP-SFNR 19	KTP-CFNR 19	
GI391	KTP-LANR 19	KTP-LANR 30	KTP-SANR 19	KTP-CANR 19xx	KTP-LFNL 19	KTP-SFNL 19	KTP-CFNL 19	
DKT		USS 0617				HXK 3		

* Special items



S-DKT(RL)5556



Basic R/L handed tool shank for KTP cartridge heads.

Suited for renovation of railway wheels. Available in shank size 56x55 mm. Body treated for longer tool life.

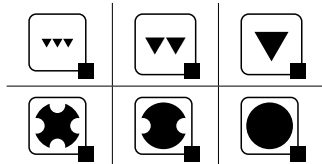
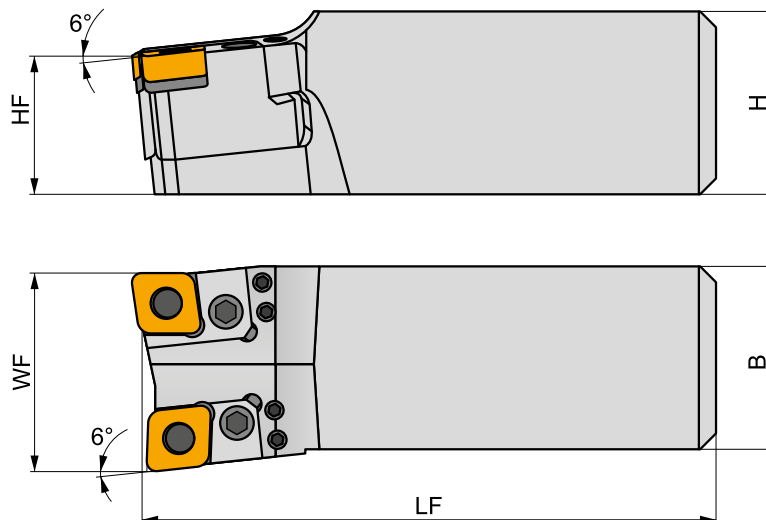
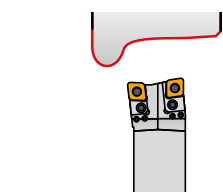

Product	H	B	LF	HF	WF	LAMS	GAMO	kg		
	(mm)	(mm)	(mm)	(mm)	(mm)	(°)	(°)			
R S-DKTR5556-000381*	56	55	176	42.3	55.5	-6	-6	3.40	GI391	DKT
L S-DKTL5556-000382*	56	55	176	42.3	55.5	-6	-6	3.40	GI390	DKT

GI390	KTP-LANL 19	KTP-LANL 30	KTP-SANL 19	KTP-CANL 19xx	KTP-LFNR 19	KTP-SFNR 19	KTP-CFNR 19
GI391	KTP-LANR 19	KTP-LANR 30	KTP-SANR 19	KTP-CANR 19xx	KTP-LFNL 19	KTP-SFNL 19	KTP-CFNL 19

DKT	USS 0617	HXK 3

* Special items



KTP-CAN(RL)



PRAMET

P



Cartridge for CNMX 19 inserts for railway wheel returning

Lever lock type R/L handed turning cartridge for negative CNMX 19 insert. For mounting on DKT tool holder. Suited for renovation of railway wheels. Tool holder treated for longer tool life.

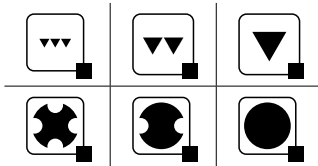
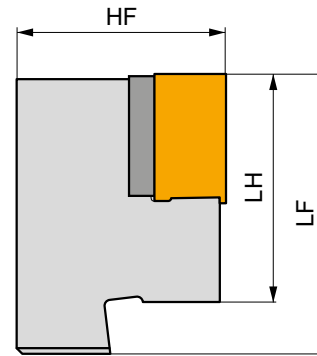
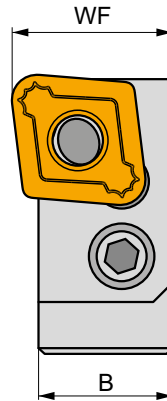
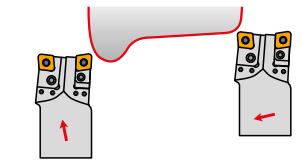

Product	HF	B	WF	LF	HF	kg		
	(mm)	(mm)	(mm)	(mm)	(mm)			
R KTP-CANR 1907	32	20.5	23	43	35	0.16	GI275	C1907
KTP-CANR 1911	32	20.5	23	43	35	0.15	GI277	C1911
KTP-CANR 1906-217	32.15	22.3	25.1	48.7	35	0.15	GI042	C1907
KTP-CANR 1906-219	32.15	26.45	29	48.7	35	0.19	GI042	C1907
L KTP-CANL 1907	32	20.5	23	43	35	0.16	GI275	C1907
KTP-CANL 1911	32	20.5	23	43	35	0.15	GI277	C1911
KTP-CANL 1906-218	32.15	22.3	25.1	48.7	35	0.15	GI042	C1907
KTP-CANL 1906-220	32.15	26.45	29	48.7	35	0.19	GI042	C1907

GI275	CNMX 1907..
GI277	CNMX 1911..
GI042	CN..1907

C1907	CNX 19X340	PU 05	US 38	8.0	M 10x1	29	NT 06	MT 06	HXX 4
C1911	CNX 19X340	PU 16	US 95	10.0	M 10x1	30.5	NT 06	MT 06	HXX 4



KTP-CFN(RL)



PRAMET

P



Cartridge for CNMX 19 inserts for railway wheel returning

Lever lock type R/L handed turning cartridge for negative CNMX 19 insert. For mounting on DKT tool holder. Suited for renovation of railway wheels. Tool holder treated for longer tool life.

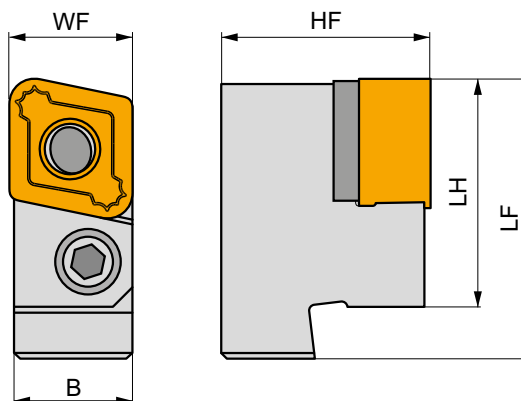
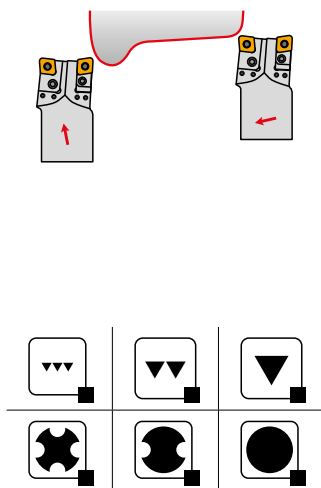

Product	HF	B	WF	LF	LH	kg		
	(mm)	(mm)	(mm)	(mm)	(mm)			
R KTP-CFNR 1907	32	18.25	19.05	43	35	0.15	GI275	C1907
KTP-CFNR 1911	32	18.25	19.05	43	35	0.14	GI277	C1911
L KTP-CFNL 1907	32	18.25	19.05	43	35	0.15	GI275	C1907
KTP-CFNL 1911	32	18.25	19.05	43	35	0.14	GI277	C1911

GI275	CNMX 1907..
GI277	CNMX 1911..

C1907	CNX 19X340	PU 05	US 38	8.0	M 10x1	29	NT 06	MT 06	HXK 4
C1911	CNX 19X340	PU 16	US 95	10.0	M 10x1	30.5	NT 06	MT 06	HXK 4



LN

19/ 30/ 31

CARBIDE INSERTS

LN. X 19, LN. X 30



122

LNMT 31



123

MATCH THE RIGHT SIZE (example)

Insert

Tool Holder

LNMX 301940SN-TF

KTP-LANR 30

DKT(RL)-A1 + KTP

		LN..
		19 30
		KTP-LAN(RL)
	50x55	
	124	122-123 131-132

DKT(RL)-A2 + KTP

		LN..
		19 30
		KTP-LAN(RL) KTP-LFN(RL)
	50x55	
	124	122-123 131-132

DKT(RL)-B1 + KTP

		LN..
		19 30
		KTP-LAN(RL)
	50x49.5	
	125	122-123 131-132

DKT(RL)-B2 + KTP

		LN..
		19 30
		KTP-LAN(RL) KTP-LFN(RL)
	50x49.5	
	125	122-123 131-132

DKT(RL)-C1 + KTP

		LN..
		19 30
		KTP-LAN(RL)
	55x55	
	126	122-123 131-132

DKT(RL)-C2 + KTP

		LN..
		19 30
		KTP-LAN(RL) KTP-LFN(RL) KTP-LAN(RL) 30/X
	55x55 55x52	
	126	122-123 131-132

DKT(RL)-D1 + KTP

		LN..
		19 30
		KTP-LAN(RL)
	50x49.5	
	127	122-123 131-132

DKT(RL)-D2 + KTP

		LN..
		19 30
		KTP-LAN(RL) KTP-LFN(RL)
	50x49.5	
	127	122-123 131-132

S-DKT(RL)4065X + KTP

		LN..
		19 30
		KTP-LAN(RL) KTP-LFN(RL)
	45x65	
	128	122-123 131-132

S-DKT(RL)5556 + KTP

		LN..
		19 30
		KTP-LAN(RL) KTP-LFN(RL)
	56x55	
	130	122-123 131-132



LN.X 19, LN.X 30



	W1 (mm)	D1 (mm)	L (mm)	S (mm)
1919	10.000	6.35	19.05	19.05
3019	12.000	6.35	30.00	19.05

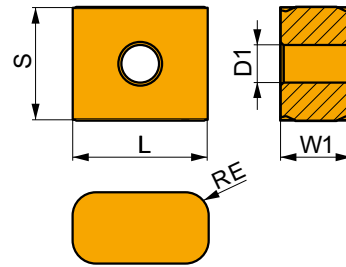

Suitability and starting values for cutting speed (vc), feed (f) and depth of cut (ap). Refer to our Machining Calculator app for further calculations.

Product	RE (mm)	P			M			K			N			S			H		
		vc (m/min)	f (mm/rev)	ap (mm)	vc (m/min)	f (mm/rev)	ap (mm)	vc (m/min)	f (mm/rev)	ap (mm)	vc (m/min)	f (mm/rev)	ap (mm)	vc (m/min)	f (mm/rev)	ap (mm)	vc (m/min)	f (mm/rev)	ap (mm)

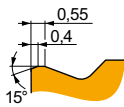

DF geometry for rough to heavy-rough machining, and continuous to interrupted cuts.

LNUX 191940SN-DF	T9325	4.0	65	1.10	4.0	-	-	-	60	1.10	4.0	-	-	-	-	-	-	-	-
-------------------------	--------------	-----	----	------	-----	---	---	---	----	------	-----	---	---	---	---	---	---	---	---

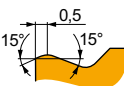

DM geometry for rough to heavy-rough machining, and continuous to interrupted cuts.

LNUX 301940SN-DM	9215	4.0	80	1.30	5.0	-	-	-	75	1.30	5.0	-	-	-	-	-	-	-	-
	T5315	4.0	80	1.30	5.0	-	-	-	75	1.30	5.0	-	-	-	-	-	15	0.55	2.7
	T9315	4.0	95	1.30	5.0	-	-	-	90	1.30	5.0	-	-	-	-	-	-	-	-
	T9325	4.0	80	1.30	5.0	-	-	-	75	1.30	5.0	-	-	-	-	-	-	-	-

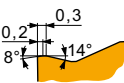

RF geometry for semi-rough to rough machining, and continuous to interrupted cuts.

LNMX 191940SN-RF	T9315	4.0	105	0.75	3.5	-	-	-	95	0.75	3.5	-	-	-	-	-	-	-	-
LNMX 301940SN-RF	T9315	4.0	105	0.75	5.0	-	-	-	95	0.75	5.0	-	-	-	-	-	-	-	-

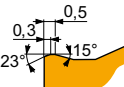

RM geometry for semi-rough to rough machining, and continuous to interrupted cuts.

LNMX 191940SN-RM	T9310	4.0	70	0.93	3.5	-	-	-	65	0.93	3.5	-	-	-	-	-	-	-	-
	T9315	4.0	105	0.93	3.5	-	-	-	95	0.93	3.5	-	-	-	-	-	-	-	-
	T9325	4.0	60	0.93	3.5	-	-	-	55	0.93	3.5	-	-	-	-	-	-	-	-
	T9335	4.0	55	1.18	6.0	-	-	-	50	1.18	6.0	-	-	-	-	-	-	-	-
LNMX 301940SN-RM	T9310	4.0	60	1.18	6.0	-	-	-	55	1.18	6.0	-	-	-	-	-	-	-	-
	T9315	4.0	95	1.18	6.0	-	-	-	90	1.18	6.0	-	-	-	-	-	-	-	-
	T9325	4.0	55	1.18	6.0	-	-	-	50	1.18	6.0	-	-	-	-	-	-	-	-

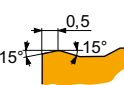

RR geometry for semi-rough to rough machining, and continuous to interrupted cuts.

LNMX 191940SN-RR	T5315	4.0	80	1.10	4.0	-	-	-	75	1.10	4.0	-	-	-	-	-	15	0.55	2.7
LNMX 301940SN-RR	T9325	4.0	55	1.10	7.0	-	-	-	50	1.10	7.0	-	-	-	-	-	-	-	-

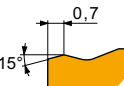

RR2 geometry for rough to heavy-rough machining, and continuous to interrupted cuts.

LNMX 191940SN-RR2	T5315	4.0	80	1.20	4.0	-	-	-	75	1.20	4.0	-	-	-	-	-	15	0.60	2.7
--------------------------	--------------	-----	----	------	-----	---	---	---	----	------	-----	---	---	---	---	---	----	------	-----

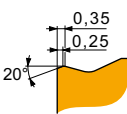

Suitability and starting values for cutting speed (vc), feed (f) and depth of cut (ap). Refer to our Machining Calculator app for further calculations.

Product	RE (mm)	P			M			K			N			S			H				
		vc (m/min)	f (mm/rev)	ap (mm)	vc (m/min)	f (mm/rev)	ap (mm)	vc (m/min)	f (mm/rev)	ap (mm)	vc (m/min)	f (mm/rev)	ap (mm)	vc (m/min)	f (mm/rev)	ap (mm)	vc (m/min)	f (mm/rev)	ap (mm)		
	0.35 0.25 20°																				
		TF geometry for semi-rough to rough machining, and continuous to interrupted cuts.																			
		LNMX 191940SN-TF	T5315	4.0	80	0.95	5.0	–	–	–	75	0.95	5.0	–	–	–	–	–	–	–	15
	T9315	4.0	75	0.95	5.0	–	–	–	70	0.95	5.0	–	–	–	–	–	–	–	15	0.48	2.7
	T9325	4.0	70	0.95	5.0	–	–	–	65	0.95	5.0	–	–	–	–	–	–	–	–	–	–
LNMX 301940SN-TF	T5315	4.0	80	0.95	7.0	–	–	–	75	0.95	7.0	–	–	–	–	–	–	–	15	0.48	2.7
	T9310	4.0	80	0.95	7.0	–	–	–	75	0.95	7.0	–	–	–	–	–	–	–	15	0.48	2.7
	T9315	4.0	75	0.95	7.0	–	–	–	70	0.95	7.0	–	–	–	–	–	–	–	15	0.48	2.7

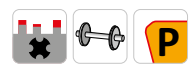
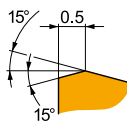

Geometry for rough to heavy-rough machining, and continuous to interrupted cuts.

LNMX 191940*	S30	4.0	40	0.85	4.0	–	–	–	–	–	–	–	–	–	–	–	–	–	–	–	–
LNMX 301940*	S30	4.0	40	0.85	4.0	–	–	–	–	–	–	–	–	–	–	–	–	–	–	–	–

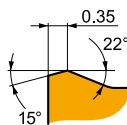

S6 geometry for semi-rough to rough machining, continuous to interrupted cuts.

S-LNMX 301940-56*	T9310	4.0	80	1.00	5.0	–	–	–	75	1.00	5.0	–	–	–	–	–	–	–	15	0.48	2.7
--------------------------	--------------	-----	----	------	-----	---	---	---	----	------	-----	---	---	---	---	---	---	---	----	------	-----

* Special items



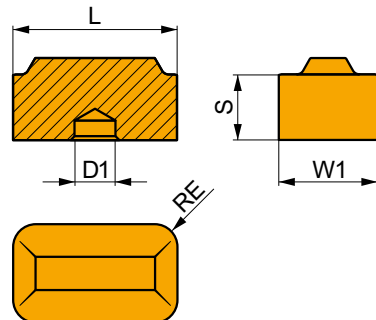

LNMT

	W1 (mm)	D1 (mm)	L (mm)	S (mm)
3112	19.050	7.93	31.75	12.70

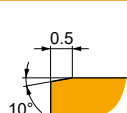

PRAMET

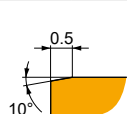
Suitability and starting values for cutting speed (vc), feed (f) and depth of cut (ap). Refer to our Machining Calculator app for further calculations.

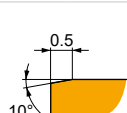
Product	RE (mm)	P			M			K			N			S			H				
		vc (m/min)	f (mm/rev)	ap (mm)	vc (m/min)	f (mm/rev)	ap (mm)	vc (m/min)	f (mm/rev)	ap (mm)	vc (m/min)	f (mm/rev)	ap (mm)	vc (m/min)	f (mm/rev)	ap (mm)	vc (m/min)	f (mm/rev)	ap (mm)		
	0.5 10°																				
		M geometry for finish to rough machining, continuous to interrupted cuts.																			
LNMT 311240SN-M	T9315	4.76	75	1.00	9.5	–	–	–	70	1.00	9.5	–	–	–	–	–	–	–	15	0.50	2.7
S-LNMT311240SN-M	T9310	4.76	–	–	–	–	–	–	–	–	–	–	–	–	–	–	–	–	–	–	–
	0.5 10°																				
		Geometry for finish to rough machining, continuous to interrupted cuts.																			
LNMT 311240	T9315	4.76	75	1.00	9.5	–	–	–	70	1.00	9.5	–	–	–	–	–	–	–	15	0.50	2.7
	0.5 10°																				
		Geometry for finish to rough machining, continuous to interrupted cuts.																			
LNMT 311240SN-R*	T9310	4.76	65	1.00	9.5	–	–	–	60	1.00	9.5	–	–	–	–	–	–	–	15	0.50	2.5
	T9315	4.76	70	1.00	9.5	–	–	–	65	1.00	9.5	–	–	–	–	–	–	–	15	0.50	2.5

* Special items



DKT(RL)-A



PRAMET

**Basic R/L handed tool shank for KTP cartridge heads.**

Suited for railway wheels returning. Available in shank size 50x55 mm. Suited for Hegenscheidt machine tools. Body treated for longer tool life.

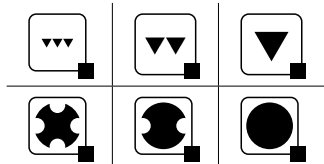
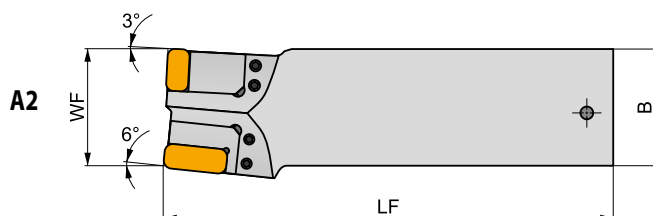
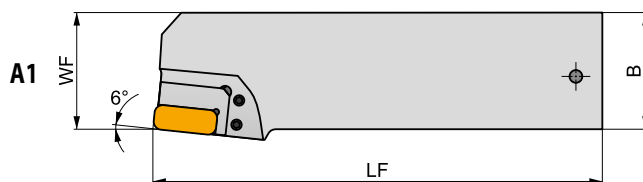
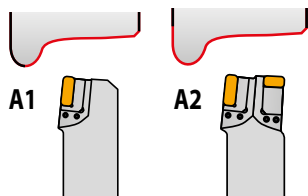

Product	H	B	LF	HF	WF	LAMS	GAMO	kg	G188	G189	G188	G1390
	(mm)	(mm)	(mm)	(mm)	(mm)	(°)	(°)					
R DKTR 5055 X A1	50	55	210	44	55	-6	-6	3.70	GI189	DKT		
DKTR 5055 X A2	50	55	210	44	55	-6	-6	3.70	GI391	DKT		
L DKTL 5055 X A1	50	55	210	44	55	-6	-6	3.82	GI188	DKT		
DKTL 5055 X A2	50	55	210	44	55	-6	-6	3.78	GI390	DKT		

G188	KTP-LANL 19	KTP-LANL 30	KTP-SANL 19	KTP-CANL 19xx	-	-	-	-
G189	KTP-LANR 19	KTP-LANR 30	KTP-SANR 19	KTP-CANR 19xx	-	-	-	-
G1390	KTP-LANL 19	KTP-LANL 30	KTP-SANL 19	KTP-CANL 19xx	KTP-LFNR 19	KTP-SFNR 19	KTP-CFNR 19	
G1391	KTP-LANR 19	KTP-LANR 30	KTP-SANR 19	KTP-CANR 19xx	KTP-LFNL 19	KTP-SFNL 19	KTP-CFNL 19	

DKT	USS 0617		HXK 3



DKT(RL)-B



Basic R/L handed tool shank for KTP cartridge heads.

Suited for railway wheels returning. Available in shank size 50x49.5 mm. Suited for Rafamet UDA 125N machine tools. Body treated for longer tool life.

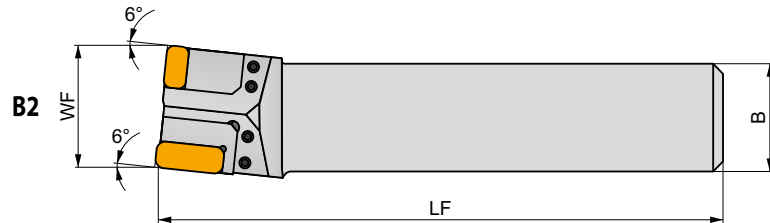
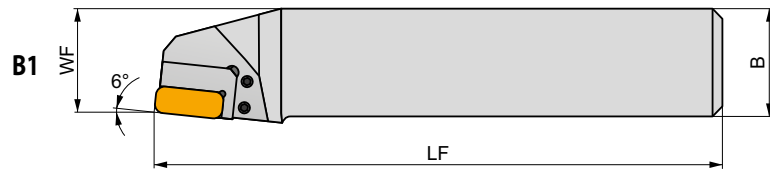
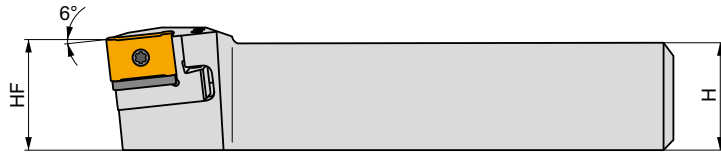
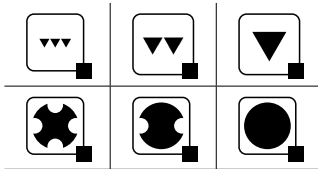
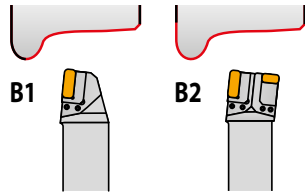

Product	H (mm)	B (mm)	LF (mm)	HF (mm)	WF (mm)	LAMS (°)	GAMO (°)	kg		
R DKTR 5050 X B1*	50	49.5	261	50	47	-6	-6	4.00	G1189	DKT
DKTR 5050 X B2*	50	49.5	261	50	55	-6	-6	4.00	G1391	DKT
L DKTL 5050 X B1*	50	49.5	261	50	47	-6	-6	4.00	G1188	DKT
DKTL 5050 X B2*	50	49.5	261	50	55	-6	-6	4.00	G1390	DKT

G1188	KTP-LANL 19	KTP-LANL 30	KTP-SANL 19	KTP-CANL 19xx	-	-	-	-	-
G1189	KTP-LANR 19	KTP-LANR 30	KTP-SANR 19	KTP-CANR 19xx	-	-	-	-	-
G1390	KTP-LANL 19	KTP-LANL 30	KTP-SANL 19	KTP-CANL 19xx	KTP-LFNR 19	KTP-SFNR 19	KTP-CFNR 19	KTP-LFNR 19	KTP-SFNR 19
G1391	KTP-LANR 19	KTP-LANR 30	KTP-SANR 19	KTP-CANR 19xx	KTP-LFNL 19	KTP-SFNL 19	KTP-CFNL 19	KTP-LFNL 19	KTP-SFNL 19

DKT	USS 0617		HXK 3

* Special items



DKT(RL)-C



PRAMET

Basic R/L handed tool shank for KTP cartridge heads.

Suited for railway wheels returning. Available in shank size 55x55 mm and 55x52 mm. Suited for Rafamet UBB 112/2 machine tools. Body treated for longer tool life.

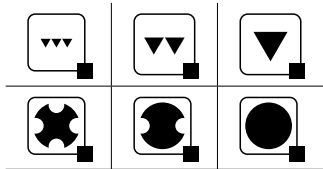
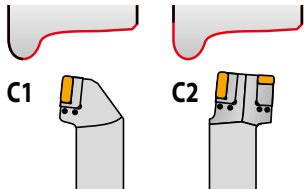
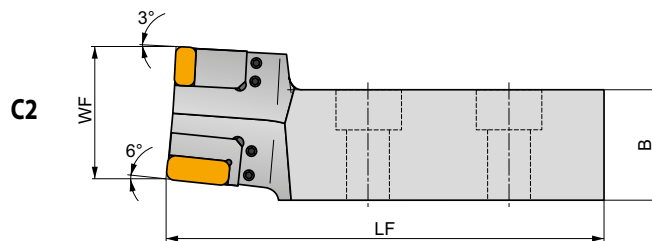
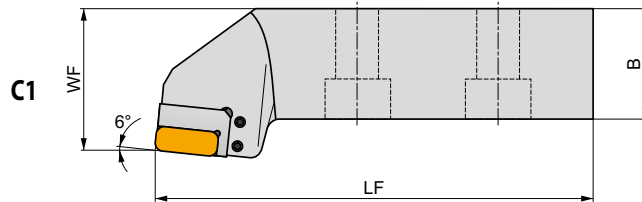
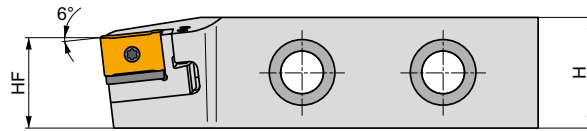

Product	H	B	LF	HF	WF	LAMS	GAMO	kg		
	(mm)	(mm)	(mm)	(mm)	(mm)	(°)	(°)			
R DKTR 5555 X C1*	55	55	217	44	70.00	-6	-6	4.10	GI189	DKT
R DKTR 5555 X C2*	55	55	217	44	65.50	-6	-6	4.10	GI391	DKT
L DKTL 5555 X C1*	55	55	217	44	70.00	-6	-6	4.10	GI188	DKT
L DKTL 5555 X C2*	55	55	217	44	65.50	-6	-6	4.10	GI390	DKT
R S-DKTR5552XC2-000231*	55	52	217	44	65.50	-6	-6	7.30	GI391	DKT
R S-DKTR5555XC2-000474*	55	55	217	44	70.00	-6	-6	7.70	GI391	DKT
L S-DKTL5552XC2-000230*	55	52	217	44	65.50	-6	-6	7.30	GI390	DKT
L S-DKTL5555XC2-000475*	55	55	217	44	70.00	-6	-6	7.70	GI390	DKT

GI188	KTP-LANL 19	KTP-LANL 30	KTP-SANL 19	KTP-CANL 19xx	-	-	-	-
GI189	KTP-LANR 19	KTP-LANR 30	KTP-SANR 19	KTP-CANR 19xx	-	-	-	-
GI390	KTP-LANL 19	KTP-LANL 30	KTP-SANL 19	KTP-CANL 19xx	KTP-LFNR 19	KTP-SFNR 19	KTP-CFNR 19	KTP-CFNR 19
GI391	KTP-LANR 19	KTP-LANR 30	KTP-SANR 19	KTP-CANR 19xx	KTP-LFNL 19	KTP-SFNL 19	KTP-CFNL 19	KTP-CFNL 19



DKT



USS 0617



HXK 3

* Special items



DKT(RL)-D



Basic R/L handed tool shank for KTP cartridge heads.

Suited for railway wheels returning. Available in shank size 50x49.5 mm. Suited for Rafamet UBB 112 machine tools. Body treated for longer tool life.

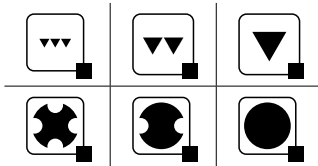
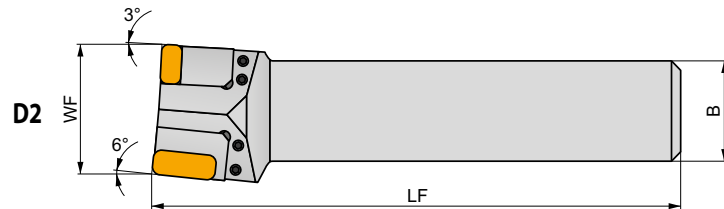
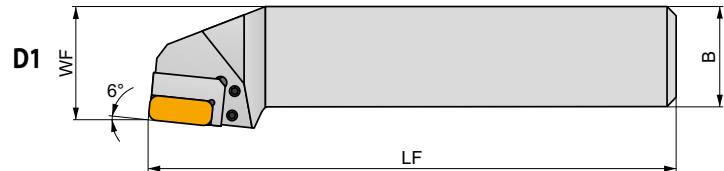
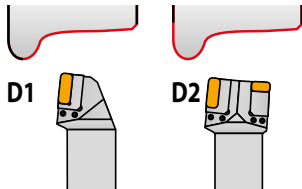

Product	H	B	LF	HF	WF	LAMS	GAMO	kg		
	(mm)	(mm)	(mm)	(mm)	(mm)	(°)	(°)			
R DKTR 5050 X D1*	50	49.5	262	50	55.50	-6	-6	4.20	G189	DKT
DKTR 5050 X D2*	50	49.5	262	50	63.00	-6	-6	4.20	G1391	DKT
L DKTL 5050 X D1*	50	49.5	262	50	55.50	-6	-6	4.20	G188	DKT
DKTL 5050 X D2*	50	49.5	262	50	63.00	-6	-6	4.20	G1390	DKT

G188	KTP-LANL 19	KTP-LANL 30	KTP-SANL 19	KTP-CANL 19xx	-	-	-	-
G189	KTP-LANR 19	KTP-LANR 30	KTP-SANR 19	KTP-CANR 19xx	-	-	-	-
G1390	KTP-LANL 19	KTP-LANL 30	KTP-SANL 19	KTP-CANL 19xx	KTP-LFNR 19	KTP-SFNR 19	KTP-CFNR 19	
G1391	KTP-LANR 19	KTP-LANR 30	KTP-SANR 19	KTP-CANR 19xx	KTP-LFNL 19	KTP-SFNL 19	KTP-CFNL 19	

DKT	USS 0617	HXK 3

* Special items



S-DKT(RL)4065X



Basic R/L handed tool shank for KTP cartridge heads or direct CNMX 19 or SNMX 19 inserts clamping.

Suited for renovation of railway wheels. Available in shank size 40x65 mm. Body treated for longer tool life.

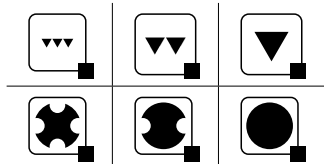
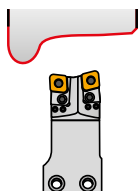
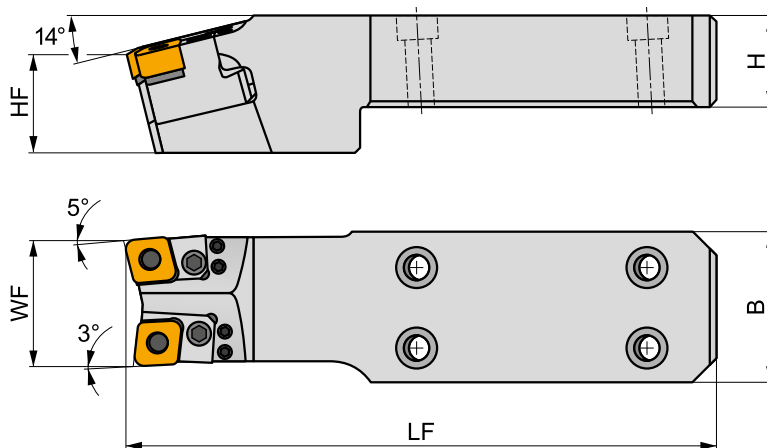

Product	H (mm)	B (mm)	LF (mm)	HF (mm)	WF (mm)	LAMS (°)	GAMO (°)	kg		
R S-DKTR4065X-000435*	40	65	255.9	22.75	54	-14	-6	4.60	G1391	USS 0617
L S-DKTL4065X-000436*	40	65	255.9	22.75	45.16	-14	-6	3.43	G1390	USS 0617
G1390	KTP-LANL 19	KTP-LANL 30	KTP-SANL 19	KTP-CANL 19xx	KTP-LFNR 19	KTP-SFNR 19	KTP-CFNR 19			
G1391	KTP-LANR 19	KTP-LANR 30	KTP-SANR 19	KTP-CANR 19xx	KTP-LFNL 19	KTP-SFNL 19	KTP-CFNL 19			

* Special items



S-DKT(RL)4065X-S



Basic R/L handed tool shank for SNMX 19 inserts clamping.

Suited for renovation of railway wheels. Available in shank size 40x65 mm. Body treated for longer tool life.

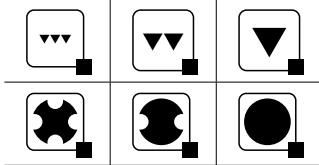
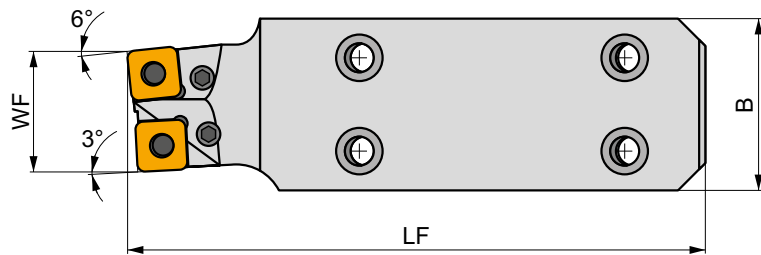
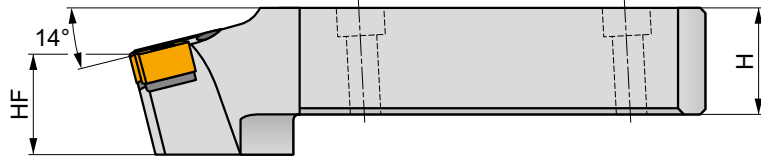
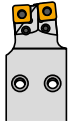

Product	H (mm)	B (mm)	LF (mm)	HF (mm)	WF (mm)	LAMS (°)	GAMO (°)	kg		
R S-DKTR4065X-000244*	40	65	217	22.1	45	-14	-6	3.71	G189	SN..1911
L S-DKTL4065X-000248*	40	65	217	22.1	45	-14	-6	3.71	G1391	SN..1911



G1277



SN..1911

C1907	CNX 19X340	PU 05	US 38	8,0	M10x1	29	NT 06	MT 06	HXK 4
C1911	CNX 19X340	PU 16	US 95	10,0	M10x1	30,5	NT 06	MT 06	HXK 4

* Special items



S-DKT(RL)5556



Basic R/L handed tool shank for KTP cartridge heads.

Suited for renovation of railway wheels. Available in shank size 56x55 mm. Body treated for longer tool life.

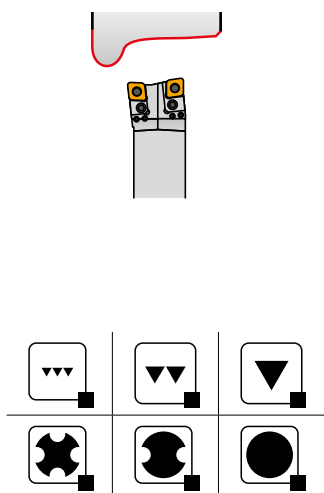
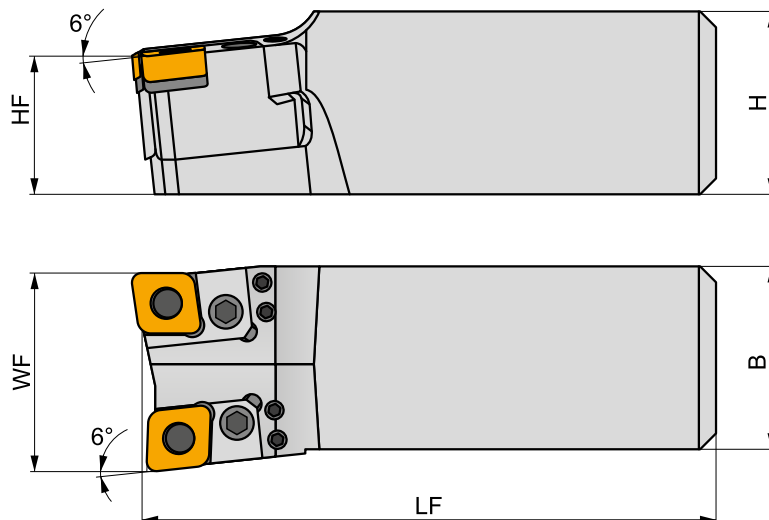

Product	H	B	LF	HF	WF	LAMS	GAMO	kg		
	(mm)	(mm)	(mm)	(mm)	(mm)	(°)	(°)			
R S-DKTR5556-000381*	56	55	176	42.3	55.5	-6	-6	3.40	GI391	DKT
L S-DKTL5556-000382*	56	55	176	42.3	55.5	-6	-6	3.40	GI390	DKT

GI390	KTP-LANL 19	KTP-LANL 30	KTP-SANL 19	KTP-CANL 19xx	KTP-LFNR 19	KTP-SFNR 19	KTP-CFNR 19
GI391	KTP-LANR 19	KTP-LANR 30	KTP-SANR 19	KTP-CANR 19xx	KTP-LFNL 19	KTP-SFNL 19	KTP-CFNL 19

DKT	USS 0617	HXK 3

* Special items



KTP-LAN(RL)



KTP-LANL

Cartridge for LN.X 19 and LN.X 30 inserts for railway wheel returning

Eccentric pin lock type R/L handed turning cartridge for negative LN.X 19 or LN.X 30 insert. For mounting on DKT tool holder. Suited for renovation of railway wheels. Tool holder treated for longer tool life.

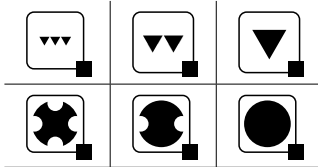
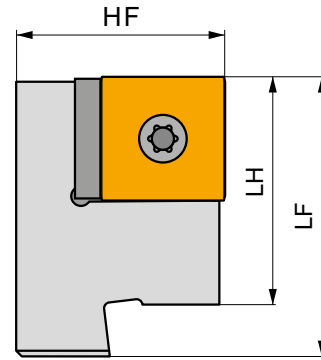
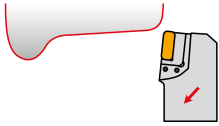

Product	HF	B	WF	LF	LH	kg		
	(mm)	(mm)	(mm)	(mm)	(mm)			
R KTP-LANR 19	32	22.6	23	43	35	0.25	GI202	LN19
KTP-LANR 30	32	22.6	23	43	35	0.17	GI200	LN30
KTP-LANR30/X-043	32	34.2	35	31	23	0.15	GI200	LN30
L KTP-LANL 19	32	22.6	23	43	35	0.25	GI202	LN19
KTP-LANL 30	32	22.6	23	43	35	0.17	GI200	LN30
KTP-LANL30/X-044	32	34.2	35	31	23	0.15	GI200	LN30

GI200	LN.X 3019..
GI202	LN.X 1919..

LN19	LNx 19T350	US 4007-T07P	UP 1515-T15P	8.0	FLAG T07P	FLAG T15P
LN30	LNx 30T350	US 4007-T07P	UP 1515-T15P	8.0	FLAG T07P	FLAG T15P



KTP-LFN(RL)



PRAMET

P



Cartridge for LN.X 19 inserts for railway wheel returning

Eccentric pin lock type R/L handed turning cartridge for negative LN.X 19. For mounting on DKT tool holder. Suited for renovation of railway wheels. Tool holder treated for longer tool life.

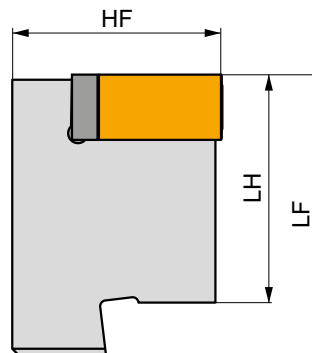
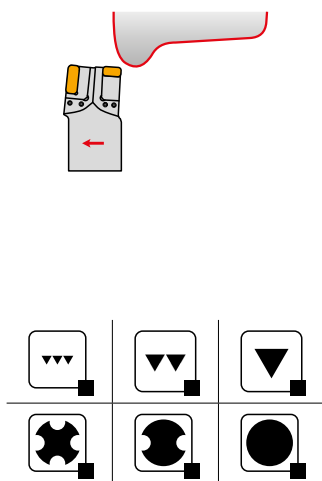

Product	≡ (mm)	B (mm)	WF (mm)	LF (mm)	LH (mm)	kg		
R KTP-LFN 19	32	18.25	19	43	35	0.15	GI202	LN19
L KTP-LFNL 19	32	18.25	19	43	35	0.15	GI202	LN19

GI202	LN.X 1919..

LN19	LN19T350	US 4007-T07P	UP 1515-T15P	8.0	FLAG T07P	FLAG T15P



CARBIDE INSERTS

SNMX 19



134

MATCH THE RIGHT SIZE (example)

Insert

SNMG 190616E-RM

Tool Holder

DSDNN 3232 P 19

DKT(RL)-A1 + KTP

		SN..
		19
		KTP-SAN(RL)
	50×55	
	135	134 142

DKT(RL)-A2 + KTP

		SN..
		19
		KTP-SAN(RL) KTP-SFN(RL)
	50×55	
	135	134 142 – 143

DKT(RL)-B1 + KTP

		SN..
		19
		KTP-SAN(RL)
	50×49.5	
	136	134 142

DKT(RL)-B2 + KTP

		SN..
		19
		KTP-SAN(RL) KTP-SFN(RL)
	50×49.5	
	136	134 142 – 143

DKT(RL)-C1 + KTP

		SN..
		19
		KTP-SAN(RL)
	55×55	
	137	134 142

DKT(RL)-C2 + KTP

		SN..
		19
		KTP-SAN(RL) KTP-SFN(RL)
	55×55 55×52	
	137	134 142 – 143

DKT(RL)-D1 + KTP

		SN..
		19
		KTP-SAN(RL)
	50×49.5	
	138	134 142 – 143

DKT(RL)-D2 + KTP

		SN..
		19
		KTP-SAN(RL) KTP-SFN(RL)
	50×49.5	
	138	134 142 – 143

S-DKT(RL)4065X + KTP

		SN..
		19
		KTP-SAN(RL) KTP-SFN(RL)
	45×65	
	139	134 142 – 143

S-DKT(RL)5556 + KTP

		SN..
		19
		KTP-SAN(RL) KTP-SFN(RL)
	56×55	
	141	134 142 – 143



SNMX 19



	IC (mm)	D1 (mm)	L (mm)	S (mm)
1906	19.050	6.35	19.05	6.35
1911	19.050	7.75	19.05	11.00

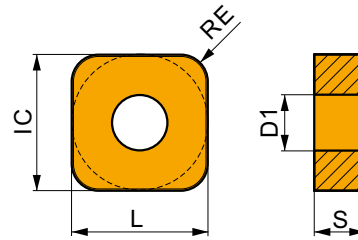

Suitability and starting values for cutting speed (vc), feed (f) and depth of cut (ap). Refer to our Machining Calculator app for further calculations.

Product	RE (mm)	P			M			K			N			S			H		
		vc (m/min)	f (mm/rev)	ap (mm)	vc (m/min)	f (mm/rev)	ap (mm)	vc (m/min)	f (mm/rev)	ap (mm)	vc (m/min)	f (mm/rev)	ap (mm)	vc (m/min)	f (mm/rev)	ap (mm)	vc (m/min)	f (mm/rev)	ap (mm)

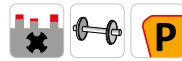
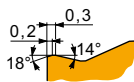

RF geometry for semi-rough to rough machining, and continuous to interrupted cuts.

SNMX 191140SN-RF	T9315	4.0	105	0.75	5.5	—	—	—	95	0.75	5.5	—	—	—	—	—	—	—	—	
S-SNMX190640SN-RF*	T5315	4.0	80	0.85	4.5	—	—	—	75	0.85	4.0	—	—	—	—	—	—	15	0.43	2.7

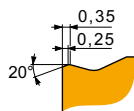

TF geometry for semi-rough to rough machining, and continuous to interrupted cuts.

SNMX 191140SN-TF	T5315	4.0	85	0.80	5.5	—	—	—	80	0.80	5.5	—	—	—	—	—	—	15	0.40	2.7
	T9315	4.0	80	0.80	5.5	—	—	—	75	0.80	5.5	—	—	—	—	—	—	15	0.40	2.7
	T9325	4.0	75	0.80	5.5	—	—	—	70	0.80	5.5	—	—	—	—	—	—	—	—	—

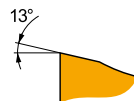

TF1 geometry for finish to semi-rough machining, continuous to interrupted cuts.

S-SNMX 190640SN-TF1*	T9315	4.0	80	0.85	2.0	—	—	—	75	0.85	2.0	—	—	—	—	—	—	15	0.40	1.5
-----------------------------	--------------	-----	----	------	-----	---	---	---	----	------	-----	---	---	---	---	---	---	----	------	-----

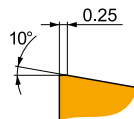

TF2 geometry for finish to semi-rough machining, continuous to interrupted cuts.

S-SNMX 190640SN-TF2*	T9315	4.0	80	0.85	2.0	—	—	—	75	0.85	2.0	—	—	—	—	—	—	15	0.40	1.5
-----------------------------	--------------	-----	----	------	-----	---	---	---	----	------	-----	---	---	---	---	---	---	----	------	-----

* Special items



DKT(RL)-A



Basic R/L handed tool shank for KTP cartridge heads.

Suited for railway wheels returning. Available in shank size 50x55 mm. Suited for Hegenscheidt machine tools. Body treated for longer tool life.

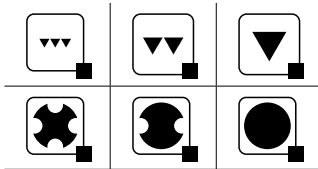
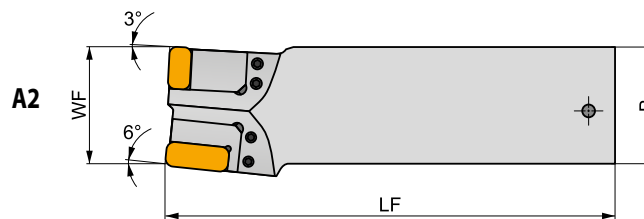
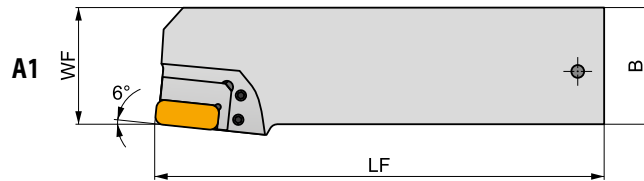
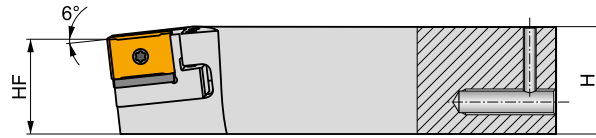
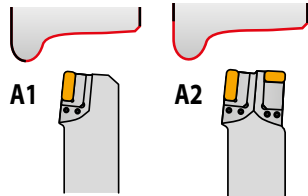

Product	H	B	LF	HF	WF	LAMS	GAMO	kg		
	(mm)	(mm)	(mm)	(mm)	(mm)	(°)	(°)			
R DKTR 5055 X A1	50	55	210	44	55	-6	-6	3.70	GI189	DKT
DKTR 5055 X A2	50	55	210	44	55	-6	-6	3.70	GI391	DKT
L DKTL 5055 X A1	50	55	210	44	55	-6	-6	3.82	GI188	DKT
DKTL 5055 X A2	50	55	210	44	55	-6	-6	3.78	GI390	DKT

GI188	KTP-LANL 19	KTP-LANL 30	KTP-SANL 19	KTP-CANL 19xx	-	-	-
GI189	KTP-LANR 19	KTP-LANR 30	KTP-SANR 19	KTP-CANR 19xx	-	-	-
GI390	KTP-LANL 19	KTP-LANL 30	KTP-SANL 19	KTP-CANL 19xx	KTP-LFNR 19	KTP-SFNR 19	KTP-CFNR 19
GI391	KTP-LANR 19	KTP-LANR 30	KTP-SANR 19	KTP-CANR 19xx	KTP-LFNL 19	KTP-SFNL 19	KTP-CFNL 19

DKT	USS 0617	HXK 3



DKT(RL)-B



Basic R/L handed tool shank for KTP cartridge heads.

Suited for railway wheels returning. Available in shank size 50x49.5 mm. Suited for Rafamet UDA 125N machine tools. Body treated for longer tool life.

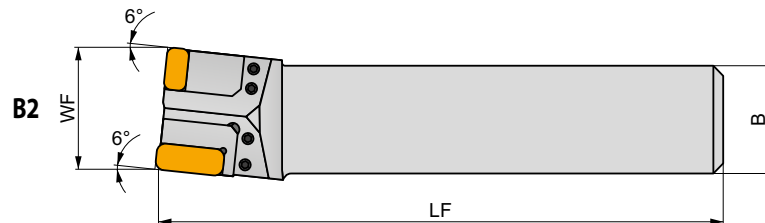
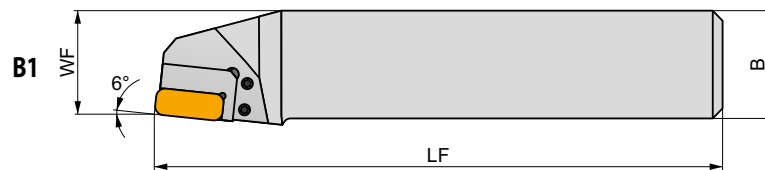
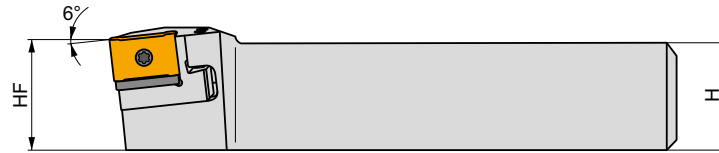
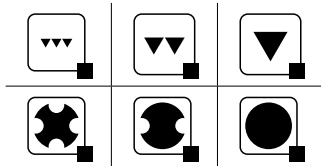
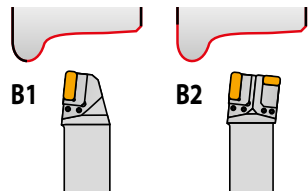

Product	H	B	LF	HF	WF	LAMS	GAMO	kg		
	(mm)	(mm)	(mm)	(mm)	(mm)	(°)	(°)			
R DKTR 5050 X B1*	50	49.5	261	50	47	-6	-6	4.00	G189	DKT
DKTR 5050 X B2*	50	49.5	261	50	55	-6	-6	4.00	G1391	DKT
L DKTL 5050 X B1*	50	49.5	261	50	47	-6	-6	4.00	G188	DKT
DKTL 5050 X B2*	50	49.5	261	50	55	-6	-6	4.00	G1390	DKT

G188	KTP-LANL 19	KTP-LANL 30	KTP-SANL 19	KTP-CANL 19xx	-	-	-	-
G189	KTP-LANR 19	KTP-LANR 30	KTP-SANR 19	KTP-CANR 19xx	-	-	-	-
G1390	KTP-LANL 19	KTP-LANL 30	KTP-SANL 19	KTP-CANL 19xx	KTP-LFNR 19	KTP-SFNR 19	KTP-CFNR 19	
G1391	KTP-LANR 19	KTP-LANR 30	KTP-SANR 19	KTP-CANR 19xx	KTP-LFNL 19	KTP-SFNL 19	KTP-CFNL 19	

DKT	USS 0617	HXK 3

* Special items



DKT(RL)-C



Basic R/L handed tool shank for KTP cartridge heads.

Suited for railway wheels returning. Available in shank size 55x55 mm and 55x52 mm. Suited for Rafamet UBB 112/2 machine tools. Body treated for longer tool life.

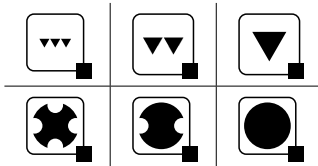
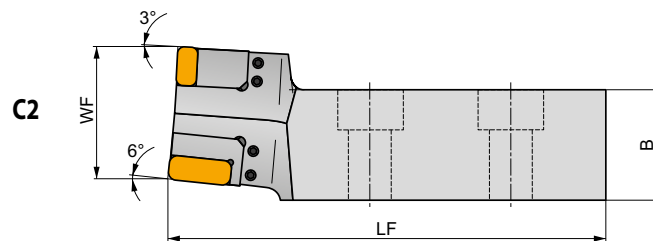
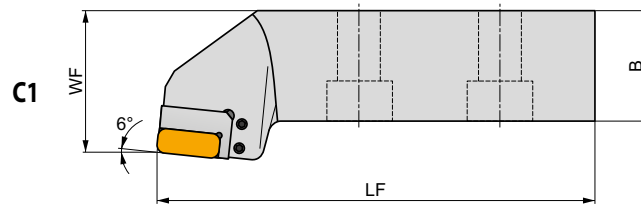
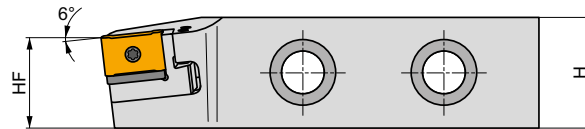
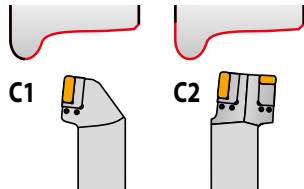

Product	H	B	LF	HF	WF	LAMS	GAMO	kg		
	(mm)	(mm)	(mm)	(mm)	(mm)	(°)	(°)			
R DKTR 5555 X C1*	55	55	217	44	70.00	-6	-6	4.10	G189	DKT
R DKTR 5555 X C2*	55	55	217	44	65.50	-6	-6	4.10	G1391	DKT
L DKTL 5555 X C1*	55	55	217	44	70.00	-6	-6	4.10	G188	DKT
L DKTL 5555 X C2*	55	55	217	44	65.50	-6	-6	4.10	G1390	DKT
R S-DKTR5552XC2-000231*	55	52	217	44	65.50	-6	-6	7.30	G1391	DKT
R S-DKTR5555XC2-000474*	55	55	217	44	70.00	-6	-6	7.70	G1391	DKT
L S-DKTL5552XC2-000230*	55	52	217	44	65.50	-6	-6	7.30	G1390	DKT
L S-DKTL5555XC2-000475*	55	55	217	44	70.00	-6	-6	7.70	G1390	DKT

G188	KTP-LANL 19	KTP-LANL 30	KTP-SANL 19	KTP-CANL 19xx	-	-	-	-	-
G189	KTP-LANR 19	KTP-LANR 30	KTP-SANR 19	KTP-CANR 19xx	-	-	-	-	-
G1390	KTP-LANL 19	KTP-LANL 30	KTP-SANL 19	KTP-CANL 19xx	KTP-LFNR 19	KTP-SFNR 19	KTP-CFNR 19	KTP-CFNR 19	KTP-CFNR 19
G1391	KTP-LANR 19	KTP-LANR 30	KTP-SANR 19	KTP-CANR 19xx	KTP-LFNL 19	KTP-SFNL 19	KTP-CFNL 19	KTP-CFNL 19	KTP-CFNL 19

DKT	USS 0617	HXK 3

* Special items



DKT(RL)-D



PRAMET

**Basic R/L handed tool shank for KTP cartridge heads.**

Suited for railway wheels returning. Available in shank size 50x49.5 mm. Suited for Rafamet UBB 112 machine tools. Body treated for longer tool life.

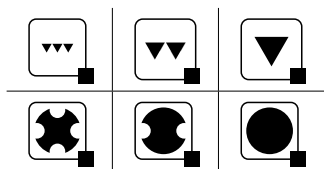
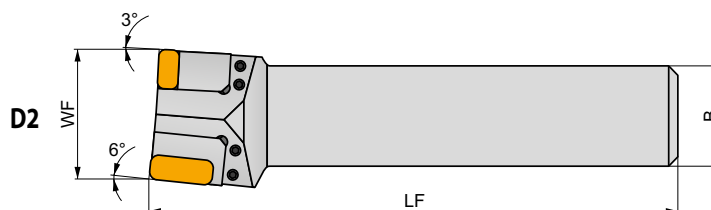
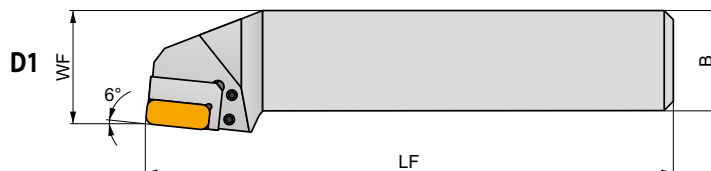
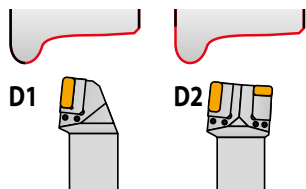

Product	H	B	LF	HF	WF	LAMS	GAMO	kg		
	(mm)	(mm)	(mm)	(mm)	(mm)	(°)	(°)			
R DKTR 5050 X D1*	50	49.5	262	50	55.50	-6	-6	4.20		GI189 DKT
DKTR 5050 X D2*	50	49.5	262	50	63.00	-6	-6	4.20		GI391 DKT
L DKTL 5050 X D1*	50	49.5	262	50	55.50	-6	-6	4.20		GI188 DKT
DKTL 5050 X D2*	50	49.5	262	50	63.00	-6	-6	4.20		GI390 DKT

GI188	KTP-LANL 19	KTP-LANL 30	KTP-SANL 19	KTP-CANL 19xx	-	-	-
GI189	KTP-LANR 19	KTP-LANR 30	KTP-SANR 19	KTP-CANR 19xx	-	-	-
GI390	KTP-LANL 19	KTP-LANL 30	KTP-SANL 19	KTP-CANL 19xx	KTP-LFNR 19	KTP-SFNR 19	KTP-CFNR 19
GI391	KTP-LANR 19	KTP-LANR 30	KTP-SANR 19	KTP-CANR 19xx	KTP-LFNL 19	KTP-SFNL 19	KTP-CFNL 19

DKT	USS 0617	HXK 3

* Special items



S-DKT(RL)4065X



Basic R/L handed tool shank for KTP cartridge heads or direct CNMX 19 or SNMX 19 inserts clamping.
Suited for renovation of railway wheels. Available in shank size 40x65 mm. Body treated for longer tool life.

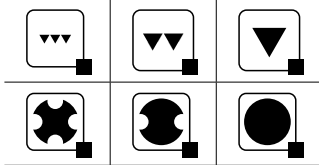
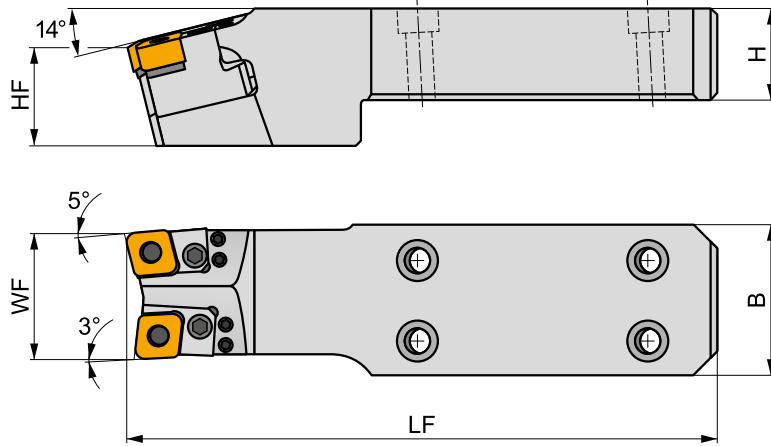
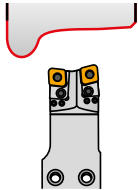

Product	H (mm)	B (mm)	LF (mm)	HF (mm)	WF (mm)	LAMS (°)	GAMO (°)	kg		
R S-DKTR4065X-000435*	40	65	255.9	22.75	54	-14	-6	4.60	GI391	USS 0617
L S-DKTL4065X-000436*	40	65	255.9	22.75	45.16	-14	-6	3.43	GI390	USS 0617

GI390	KTP-LANL 19	KTP-LANL 30	KTP-SANL 19	KTP-CANL 19xx	KTP-LFNR 19	KTP-SFNR 19	KTP-CFNR 19
GI391	KTP-LANR 19	KTP-LANR 30	KTP-SANR 19	KTP-CANR 19xx	KTP-LFNL 19	KTP-SFNL 19	KTP-CFNL 19

* Special items



S-DKT(RL)4065X-S



Basic R/L handed tool shank for SNMX 19 inserts clamping.

Suited for renovation of railway wheels. Available in shank size 40x65 mm. Body treated for longer tool life.

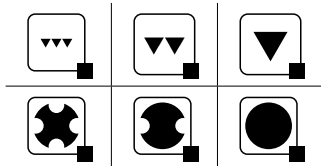
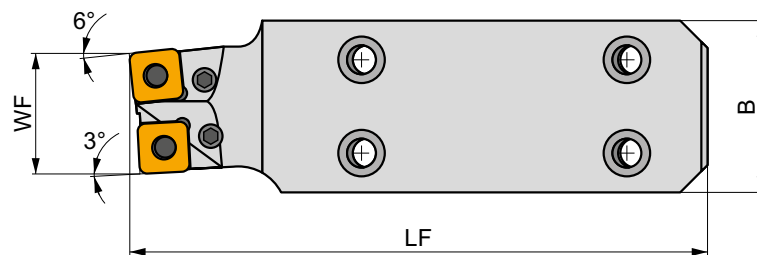
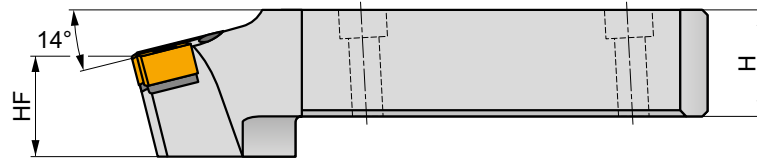
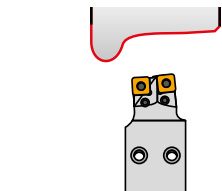

Product	H (mm)	B (mm)	LF (mm)	HF (mm)	WF (mm)	LAMS (°)	GAMO (°)	kg		
R S-DKTR4065X-000244*	40	65	217	22.1	45	-14	-6	3.71	G189	SN..1911
L S-DKTL4065X-000248*	40	65	217	22.1	45	-14	-6	3.71	G1391	SN..1911

G1277										SN..1911

C1907	CNX 19X340	PU 05	US 38	8,0	M10x1	29	NT 06	MT 06	HXK 4
C1911	CNX 19X340	PU 16	US 95	10,0	M10x1	30,5	NT 06	MT 06	HXK 4

* Special items



S-DKT(RL)5556



Basic R/L handed tool shank for KTP cartridge heads.

Suited for renovation of railway wheels. Available in shank size 56x55 mm. Body treated for longer tool life.

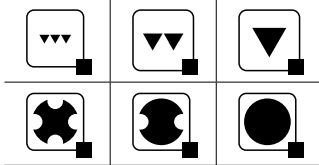
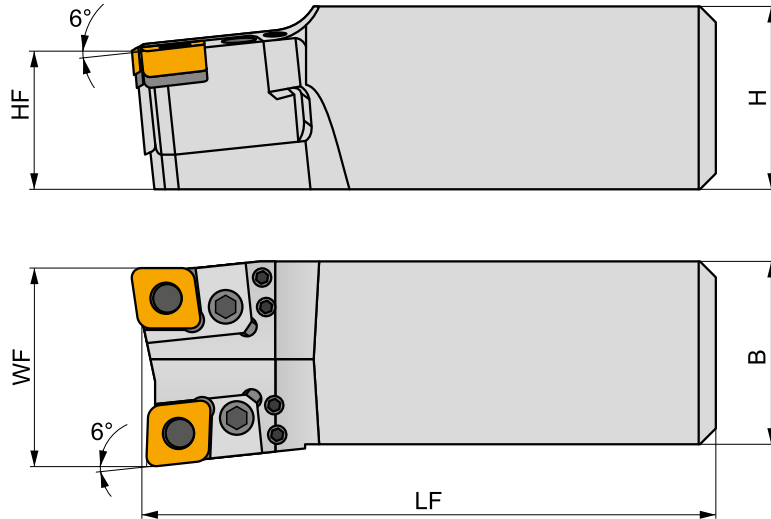
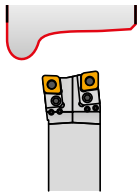

Product	H	B	LF	HF	WF	LAMS	GAMO	kg		
	(mm)	(mm)	(mm)	(mm)	(mm)	(°)	(°)			
R S-DKTR5556-000381*	56	55	176	42.3	55.5	-6	-6	3.40	GI391	DKT
L S-DKTL5556-000382*	56	55	176	42.3	55.5	-6	-6	3.40	GI390	DKT

GI390	KTP-LANL 19	KTP-LANL 30	KTP-SANL 19	KTP-CANL 19xx	KTP-LFNR 19	KTP-SFNR 19	KTP-CFNR 19
GI391	KTP-LANR 19	KTP-LANR 30	KTP-SANR 19	KTP-CANR 19xx	KTP-LFNL 19	KTP-SFNL 19	KTP-CFNL 19

DKT	USS 0617	HXK 3

* Special items



KTP-SAN(RL)



Cartridge for SNMX 19 inserts for railway wheel returning

Lever lock type R/L handed turning cartridge for negative SNMX 19 insert. For mounting on DKT tool holder. Suited for renovation of railway wheels. Tool holder treated for longer tool life.

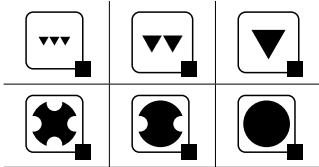
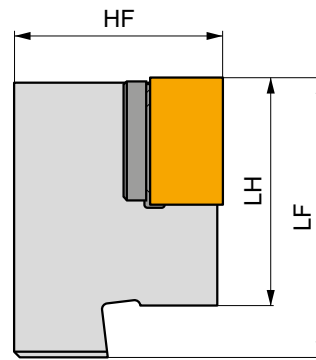
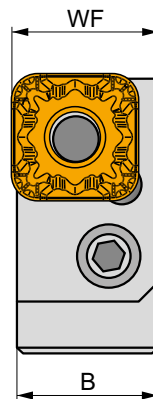
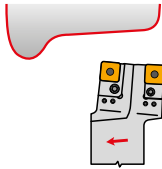

Product	⌀	B	WF	LF	HF	kg		
	(mm)	(mm)	(mm)	(mm)	(mm)			
R KTP-SANR 19	32	22	23	43	35	0.20	GI203	SN19
L KTP-SANL 19	32	22	23	43	35	0.20	GI203	SN19

GI203	SNMX 1911..

SN19	SNX 19X340	PU 16	US 95	10.0	M 10x1	30.5	NT 06	MT 06	HXK 4



KTP-SFN(RL)



Cartridge for SNMX 19 inserts for railway wheel returning

Lever lock type R/L handed turning cartridge for negative SNMX 19 insert. For mounting on DKT tool holder. Suited for renovation of railway wheels. Tool holder treated for longer tool life.

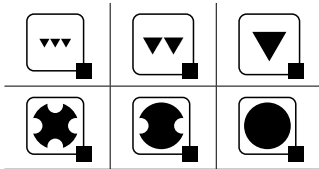
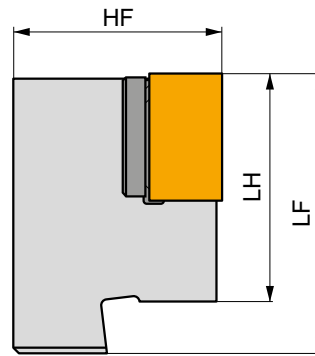
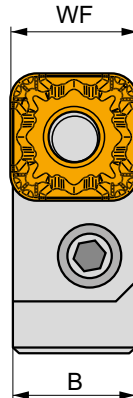
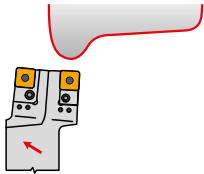

Product	HF (mm)	B (mm)	WF (mm)	LF (mm)	LH (mm)	kg		
R KTP-SFNR 19	32	18.25	19	43	35	0.16	GI203	SN19
L KTP-SFNL 19	32	18.25	19	43	35	0.16	GI203	SN19



GI203



SNMX 1911..



SN19



SNX 19X340



PU 16



US 95



10.0



M 10x1



30.5



NT 06



MT 06



HXK 4



TN

33/ 39

CARBIDE INSERTS

TNMN



145

TU 14

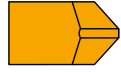

145



TNMN



	IC (mm)	L (mm)	S (mm)
33	19.05	33.00	10.00
39	22.70	39.30	10.00

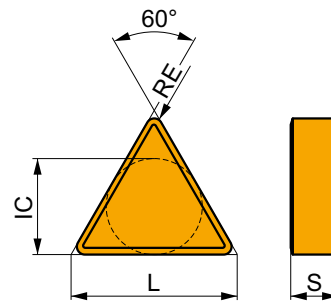

Suitability and starting values for cutting speed (vc), feed (f) and depth of cut (ap). Refer to our Machining Calculator app for further calculations.

Product	RE (mm)	P			M			K			N			S			H		
		vc (m/min)	f (mm/rev)	ap (mm)	vc (m/min)	f (mm/rev)	ap (mm)	vc (m/min)	f (mm/rev)	ap (mm)	vc (m/min)	f (mm/rev)	ap (mm)	vc (m/min)	f (mm/rev)	ap (mm)	vc (m/min)	f (mm/rev)	ap (mm)

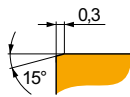

Geometry for roughing to heavy-rough machining, and continuous to interrupted cuts.

TNMN 33-013001*

S30	4.0	40	0.85	4.0	-	-	-	-	-	-	-	-	-	-	-	-	-	-
-----	-----	----	------	-----	---	---	---	---	---	---	---	---	---	---	---	---	---	---

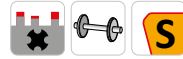
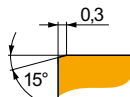

Geometry for roughing to heavy-rough machining, and continuous to interrupted cuts.

TNMN 39-018102*

S30	6.0	40	0.85	4.0	-	-	-	-	-	-	-	-	-	-	-	-	-
-----	-----	----	------	-----	---	---	---	---	---	---	---	---	---	---	---	---	---

* Special items

TU 14



	W1 (mm)	L (mm)	S (mm)
14	14.10	24.70	7.50

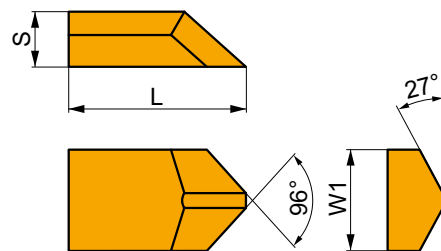

Suitability and starting values for cutting speed (vc), feed (f) and depth of cut (ap). Refer to our Machining Calculator app for further calculations.

Product	RE (mm)	P			M			K			N			S			H		
		vc (m/min)	f (mm/rev)	ap (mm)	vc (m/min)	f (mm/rev)	ap (mm)	vc (m/min)	f (mm/rev)	ap (mm)	vc (m/min)	f (mm/rev)	ap (mm)	vc (m/min)	f (mm/rev)	ap (mm)	vc (m/min)	f (mm/rev)	ap (mm)



External chip breaker - used with TNMN inserts.

TU 14-2500612*	GJ6	-	-	-	-	-	-	-	-	-	-	-	-	-	-	-	-	-
	GJ11	-	-	-	-	-	-	-	-	-	-	-	-	-	-	-	-	-

* Special items



RAILWAY – MILLING ASSORTMENT





7		INTRODUCTION & ASSORTMENT HIGHLIGHTS
13	RAILWAY INDUSTRY	PRODUCTION OF NEW RAILWAY WHEELS
20		RAILWAY WHEEL RECONDITIONING
26		AXLES MACHINING
30		STATIONARY & DYNAMIC RAIL MILLING
37		TURNOUTS MACHINING
57		BASE PLATES MACHINING
63		WAGON & BOGIE PARTS MACHINING
73		TURNING ASSORTMENT
88	POSITIVE INSERTS	
107	NEGATIVE INSERTS	
146	INDEXABLE MILLS	
166		TECHNICAL PART



CUTTING TOOL PARAMETERS ACCORDING TO ISO 13399

All cutting tools are defined by a number of parameters according to the standard ISO 13399. This list contains all the parameters used in this catalogue and their definitions.

ISO 13399 is an international cutting tool information standard. It provides dimensions and parameters in a neutral format that is independent of any particular system or company nomenclature. When cutting tools are clearly defined according to a global standard, all types of software can process the electronic data more quickly, improving the quality of communication and helping to make the exchange of information run smoothly. Supporting a common language in our cutting tool descriptions this will assist system to system communication. It will save you a significant amount of time, providing an easier gathering of high-quality data across our 40,000 solid and indexable tools. By using an ISO 13399 compliant system, there will be no need to manually interpret data and key-enter it into your system.

EXAMPLES ONLY!

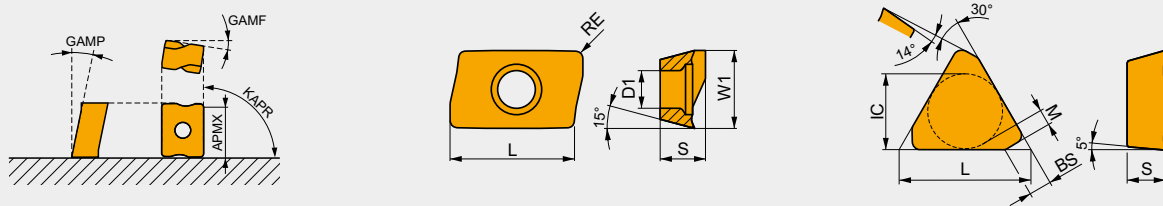

ISO 13399 code	Description
APMX	Depth of cut maximum
BD	Body diameter
BDX	Body diameter maximum
BCH	Corner chamfer length
BS	Wiper edge length
CBDP	Connection bore depth
CDI	Insert cutting diameter
CDX	Cutting depth maximum
CW	Cutting width
CZC MS	Connection size code machine side
D1	Fixing hole diameter
DAH4	Diameter access hole
DAH5	Diameter access hole
DAH6	Diameter access hole
DBC1	Diameter bolt circle 1
DBC2	Diameter bolt circle 2
DBC4	Diameter bolt circle
DBC5	Diameter bolt circle
DBC6	Diameter bolt circle
DC	Cutting diameter
DCB	Connection bore diameter
DCCB	Counterbore diameter connection bore
DCN	Cutting diameter minimum
DCON MS	Connection diameter
DCX	Cutting diameter maximum
DHUB	Hub diameter
DN	Neck diameter
GAMF	Radial rake angle
GAMP	Axial rake angle

ISO 13399 code	Description
CHW	Corner chamfer width
IC	Inscribed circle diameter
INSD	Insert diameter
INSL	Insert length
KAPR	Tool cutting edge angle
KWD	Keyway depth
KWW	Keyway width
L	Cutting edge length
LB	Body length
LE	Cutting edge effective length
LF	Functional length
LH	Head length
LU	Usable length
LUX	Usable length maximum
M	M-dimension
NOF	Number of flutes
OAL	Overall length
P	Pitch of the blade
PRFA	Profile angle
PRFRAD(2)	Profile radius
RE	Radius
S	Insert thickness
S1	Insert thickness total
TDZ	Thread diameter size
TP	Thread pitch
TPI	Threads per inch
W1	Insert width
ZNP	Number of peripheral edges in the tool



FOR MACHINING OF SWITCHES, BASE PLATES, DYNAMIC RAIL MILLING AND WHEEL RECONDITIONING

(S-)SNE. 12 – 15 (RE)  150	(S-)SN.. 12; 15 (CHW)  150	(S-)SNE. 12; 15 (KCH)  151	LNE 434  151	513000; LNEQ 28  151
(S-)CN.. 08 – 15  152	(S-)SN.. 12; 15 (RE)  152	(S-)LNE. 13; 15 (RE)  152	(S-)SN../(S-)LNEQ 12; 15 (RE)  153	(S-)SN.. 15 (CEMR)  153
(S-)SN.. 12; 15 (CEMR)  154	(S-)XOEX 12  154	(S-)LDEX 12; 13 (CEMR)  155	S-CDEW 11/(S-)XDE. 12 – 16  155	(S-)SN.. 12; 16 (CEMR)  156
SNXN 13  157	SNEX 13; 15 (CEMR)  157	(S-)SNEX 13 – 27  158	(S-)SP.X 12 – 27  159	(S-)SN.Q 15  160
S-LNEX 15  160	(S-)LPGX 27  161	(S-)SP.W 14 – 19  161	S-SPEN 12  162	S-SPEN 12; 15  162
S-RPGN 20  163	(S-)LC 16 – 32  163	(S-)LC 32  164	RNGX 12  164	ROEX 15  163
S-RNEX 15  165	S-RNEX 16  165			



(S-)SNE. 12 – 15 (RE)

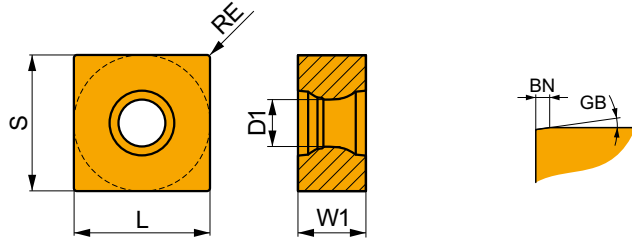

Product	W1 (mm)	L (mm)	S (mm)	D1 (mm)	RE (mm)	BN (mm)	GB (°)	CEDC	NSIDE	7310	8215	M8310	M8325	M8326	M8330	M8340	M8345	M8346	M9315	M9325	M9340
										—	—	—	—	—	—	—	—	—	—	—	—
SNEQ 12-410000	6.35	12.700	12.700	4.4	0.40	0.15	8	8	2	—	—	—	—	—	—	—	—	●	—	●	—
S-SNEQ 12-410000	6.35	12.700	12.700	4.4	0.40	0.15	8	8	2	—	—	—	—	—	○	○	—	—	—	—	○
SNEX 12-2500021	7.94	13.000	13.000	5.5	0.25	—	—	8	2	—	—	—	—	—	—	—	—	—	—	—	—
SNEX 12-2482000	8.20	13.200	13.200	5.5	0.25	—	—	8	2	—	—	—	—	—	—	—	—	—	—	—	—
SNEX 13-2222000	6.35	13.500	13.500	4.4	0.40	—	—	8	2	—	—	—	—	—	—	—	—	—	—	—	—
SNEX 13-2223000	6.46	13.500	13.500	4.4	0.40	—	—	8	2	—	—	—	—	—	—	—	—	—	—	—	—
S-SNEX 13-001317	7.30	13.500	13.500	5.5	0.20	—	—	8	2	○	—	—	—	—	—	—	—	—	—	—	—
SNEX 15-2300000	7.00	15.700	15.700	5.5	0.20	—	—	8	2	○	—	—	—	—	—	—	—	—	—	—	—
S-SNEQ 15-001885	6.35	15.875	15.875	5.6	0.80	0.25	30	8	2	—	—	—	—	—	—	—	○	—	—	—	—
SNEQ 15-520000	7.94	15.875	15.875	5.5	0.40	0.20	15	8	2	—	—	—	—	—	—	—	●	—	●	○	—
SNEQ 15-2422000	7.94	15.875	15.875	5.5	0.40	—	—	8	2	●	—	—	—	—	—	—	—	—	—	—	—

(S-)SN.. 12; 15 (CHW)

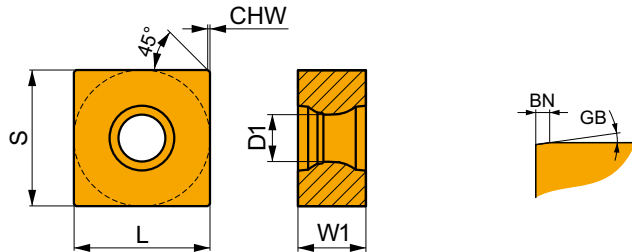

Product	W1 (mm)	L (mm)	S (mm)	D1 (mm)	CHW (mm)	BN (mm)	GB (°)	CEDC	NSIDE	7310	8215	M8310	M8325	M8326	M8330	M8340	M8345	M8346	M9315	M9325	M9340
										—	—	—	—	—	—	—	—	—	—	—	—
SNEQ 12-1118000	6.35	12.700	12.700	4.40	0.4	0.140	15	8	2	—	—	—	—	—	—	—	—	—	—	○	—
SNEX 12-2118000	6.35	12.700	12.700	4.40	0.5	—	—	8	2	—	—	○	—	—	—	—	—	—	—	—	—
SNEX 12-2431000	6.35	12.700	12.700	4.40	0.5	0.050	3	8	2	—	—	—	—	—	—	—	—	○	—	—	—
S-SNEX 12-2431000	6.35	12.700	12.700	4.40	0.5	0.050	3	8	2	—	—	—	—	—	○	—	—	—	—	—	○
S-SNXQ 12-001847	6.35	12.700	12.700	5.30	—	0.824	20	8	2	—	—	—	—	—	—	—	—	○	—	—	—
SNXQ 12-1601000	7.94	12.700	12.700	5.50	0.2	—	—	8	2	—	—	—	—	—	—	—	—	—	—	●	—
S-SNEX 15-2462000	7.94	15.000	15.000	4.40	0.5	—	—	8	2	●	—	—	—	—	—	—	—	—	—	—	—
S-SNEQ 15-001886	5.56	15.875	15.875	5.55	—	0.350	25	8	2	—	—	—	—	—	—	—	—	○	—	—	—
SNEA 15-2019000	7.94	15.875	15.875	5.30	0.5	—	—	8	2	—	—	○	—	—	—	—	—	—	—	—	—
S-SNEA 15-2019000	7.94	15.875	15.875	5.30	0.5	—	—	8	2	—	—	—	—	—	—	—	—	○	—	—	—
SNEQ 15-2501252	7.94	15.875	15.875	5.50	0.5	0.050	3	8	2	—	—	—	—	—	—	—	—	○	—	○	○



(S-)SNE. 12; 15 (KCH)

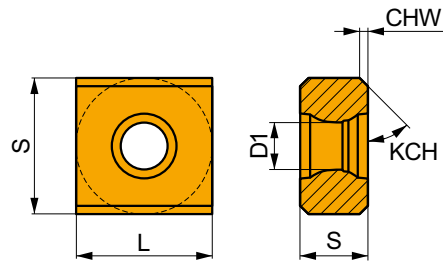

Product	W1	L	S	D1	CHW	KCH	CEDC	NSIDE	7310	8215	M8310	M8325	M8326	M8330	M8340	M8345	M8346	M9315	M9325	M9340	
	(mm)	(mm)	(mm)	(mm)	(mm)	(°)															
S-SNEQ 12-000419	6.35	12.700	12.700	4.4	0.8	45	4	2	—	—	—	—	—	—	—	—	●	—	○	—	—
SNEQ 15-2421000	7.94	15.875	15.875	5.3	0.8	45	4	2	—	—	—	—	—	—	—	—	—	—	—	—	—

LNE 434

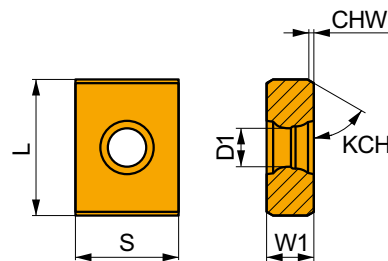

Product	W1	L	S	D1	CHW	KCH	CEDC	NSIDE	7310	8215	M8310	M8325	M8326	M8330	M8340	M8345	M8346	M9315	M9325	M9340	
	(mm)	(mm)	(mm)	(mm)	(mm)	(°)															
LNE 434-100	6.35	19.05	14.29	5.5	0.75	30	4	2	—	—	—	●	—	—	○	—	○	—	—	—	—

513000; LNEQ 28

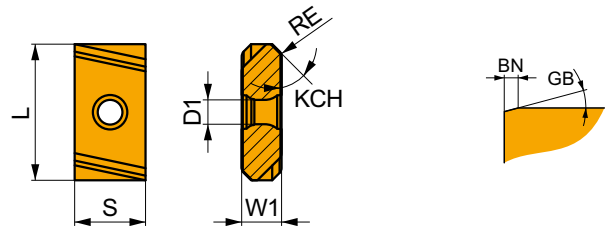

Product	W1	L	S	D1	RE	KCH	BN	GB	CEDC	NSIDE	7310	8215	M8310	M8325	M8326	M8330	M8340	M8345	M8346	M9315	M9325	M9340	
	(mm)	(mm)	(mm)	(mm)	(mm)	(°)	(mm)	(°)															
513000	7.11	24.13	12.70	4.4	1.2	45	0.20	15	4	2	—	—	—	●	—	—	—	—	○	—	○	—	—
LNEQ 28-1821000	9.52	28.60	14.30	6.5	—	30	—	—	4	2	—	—	—	—	—	—	—	—	—	—	—	—	—
LNEQ 28-2500782	9.52	28.57	15.88	5.6	—	30	0.25	15	4	2	—	—	—	—	—	—	—	—	—	—	—	—	—

(S-)CN.. 08 – 15

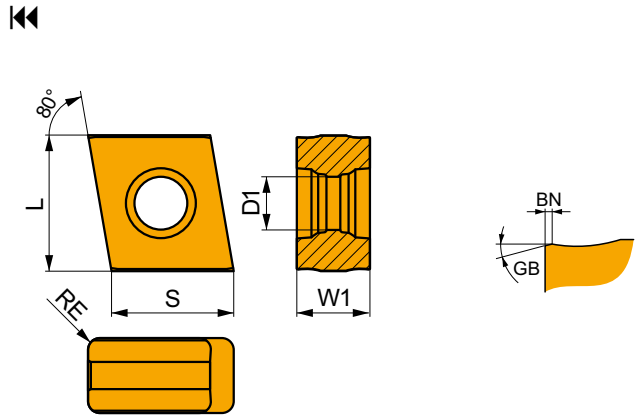

Product	W1 (mm)	L (mm)	S (mm)	D1 (mm)	RE (mm)	BN (mm)	GB (°)	CEDC	NSIDE	7310	8215	M8310	M8325	M8326	M8330	M8340	M8345	M8346	M9315	M9325	M9340	
										-	-	-	○	-	-	-	-	-	-	-	-	-
CNHU 08-1691000	5.00	9.1	7.90	3.5	0.8	0.10	12	4	2	-	-	-	○	-	-	-	-	-	-	-	-	-
CNHU 08-2044000	5.00	9.1	7.90	3.5	0.8	0.10	12	4	2	-	-	-	-	-	-	-	-	-	-	-	-	-
S-CNHU 08-1691000	5.00	9.1	7.90	3.5	0.8	0.10	12	4	2	-	-	-	-	-	-	-	-	○	-	-	-	-
CNHU 08-1345000	5.00	8.1	8.90	3.5	0.8	0.15	12	4	2	-	-	-	-	-	-	-	-	-	-	-	-	-
CNE 635-600000	6.35	12.9	11.95	4.4	0.4	0.10	15	4	2	-	-	-	●	-	-	-	-	-	-	-	-	-
CNE 635-635000	6.35	12.9	12.70	4.4	1.2	0.10	15	4	2	-	-	-	-	-	-	-	-	○	-	-	-	-
CNM 563	8.00	16.2	15.00	5.5	1.2	0.10	0	4	2	-	○	-	-	-	○	○	○	-	-	-	-	-

(S-)SN.. 12; 15 (RE)

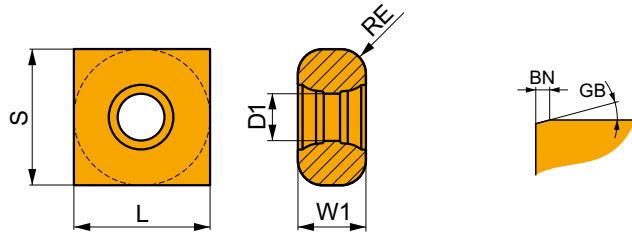

Product	W1 (mm)	L (mm)	S (mm)	D1 (mm)	RE (mm)	BN (mm)	GB (°)	CEDC	NSIDE	7310	8215	M8310	M8325	M8326	M8330	M8340	M8345	M8346	M9315	M9325	M9340	
										-	-	-	-	-	-	-	-	-	-	-	-	-
S-SNCQ 12-000211	6.35	12.700	12.700	4.4	0.8	0.2	15	4	2	-	-	-	-	-	-	-	-	-	-	○	-	-
SNCQ 12-485001	6.35	12.700	12.700	4.4	1.2	0.2	15	4	2	-	-	-	●	-	-	-	-	○	-	-	-	-
S-SNCQ 12-485003	6.35	12.700	12.700	4.4	2.0	0.2	15	4	2	-	○	-	-	-	-	-	-	○	-	-	-	-
SNCQ 12-485002	6.35	12.700	12.700	4.4	3.0	0.2	15	4	2	-	-	-	●	-	-	-	-	○	-	-	-	-
SNEX 15-2501818	7.94	15.000	15.000	4.4	2.0	-	-	4	2	○	-	-	-	-	-	-	-	-	-	○	-	-
SNEQ 15-2501257	7.94	15.875	15.875	5.5	2.0	-	-	4	2	-	-	-	-	-	-	-	-	○	-	-	-	-
S-SNUQ 15-001290	7.94	15.875	15.875	5.5	3.0	0.2	15	4	2	-	-	-	-	-	-	-	-	●	-	-	-	-

(S-)LNE. 13; 15 (RE)

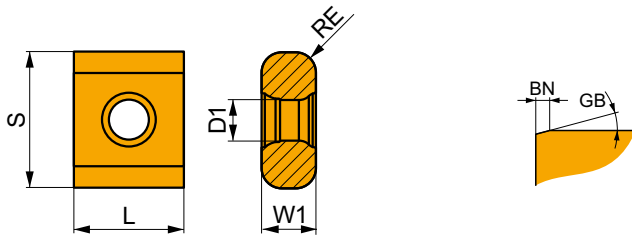

Product	W1 (mm)	L (mm)	S (mm)	D1 (mm)	RE (mm)	BN (mm)	GB (°)	CEDC	NSIDE	7310	8215	M8310	M8325	M8326	M8330	M8340	M8345	M8346	M9315	M9325	M9340	
										-	-	-	-	-	-	-	-	-	-	-	-	-
LNEQ 15-2500104	6.35	15.875	12.7	4.65	2.5	0.15	15	4	2	-	-	-	-	-	-	-	-	○	-	-	-	-
S-LNEX 15-001866	7.94	15.875	12.7	5.90	2.0	-	-	4	2	-	-	-	-	-	-	-	-	○	-	-	-	-
S-LNEQ 13-001368	7.94	15.000	13.5	4.40	2.0	-	-	4	2	○	-	-	-	-	-	-	-	-	-	-	-	-



(S-)SN../(S-)LNEQ 12; 15 (RE)

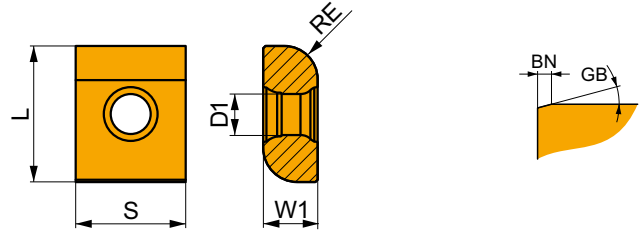

Product	W1 (mm)	L (mm)	S (mm)	D1 (mm)	RE (mm)	BN (mm)	GB (°)	CEDC	NSIDE	7310	8215	M8310	M8325	M8326	M8330	M8340	M8345	M8346	M9315	M9325	M9340	
										—	—	—	—	—	—	—	—	—	—	—	—	—
S-SNXQ 12-001858	6.35	12.700	12.700	5.80	4.00	—	—	4	2	—	—	—	—	—	—	—	—	—	—	—	—	—
S-SNCQ 12-000416	6.35	12.700	12.700	4.40	5.00	0.20	15	4	2	—	—	—	—	—	—	—	—	—	—	—	—	—
LNEQ 15-1389000	6.35	15.875	12.700	4.65	3.00	0.20	15	4	2	—	—	—	○	—	—	—	—	—	—	—	—	—
S-LNEQ 15-2001000	6.35	15.875	12.700	4.65	4.00	0.20	15	4	2	—	—	—	○	—	—	—	—	—	—	—	—	—
S-SNEQ 15-000107	7.94	15.875	15.875	5.50	3.55	0.25	11	4	2	—	—	—	—	—	—	—	—	—	○	—	—	—
SNEQ 15-2501569	7.94	15.875	15.875	5.50	4.00	0.20	15	4	2	—	—	—	—	—	—	—	—	—	○	—	—	—
S-SNEQ 15-000194	7.94	15.875	15.875	5.50	5.00	0.12	15	4	2	—	—	—	—	—	—	—	—	—	○	—	—	—
SNEQ 15-2042000	7.94	15.875	15.875	5.50	6.35	—	—	4	2	—	—	—	—	—	—	—	—	—	—	—	—	—

(S-)SN.. 15 (CEMR)

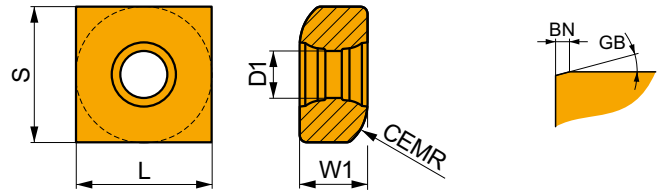

Product	W1 (mm)	L (mm)	S (mm)	D1 (mm)	CEMR (mm)	BN (mm)	GB (°)	CEDC	NSIDE	7310	8215	M8310	M8325	M8326	M8330	M8340	M8345	M8346	M9315	M9325	M9340	
										—	—	—	—	—	—	—	—	—	—	—	—	—
S-SNGX 15-001112	7.94	15.875	15.875	5.5	6	0.2	15	4	2	—	—	—	—	—	—	—	—	—	○	—	—	—
SNGX 15-546000	7.94	15.875	15.875	5.5	7	0.2	15	4	2	—	—	—	—	—	—	—	—	●	—	●	—	—
S-SNEX 15-001874	7.94	15.875	15.875	5.8	7	0.2	15	4	2	—	—	—	—	—	—	—	—	—	○	—	—	—
S-SNEQ 15-001077	7.94	15.875	15.875	5.5	10	—	—	4	2	—	—	—	—	—	—	—	—	—	○	—	—	—



(S-)SN.. 12; 15 (CEMR)

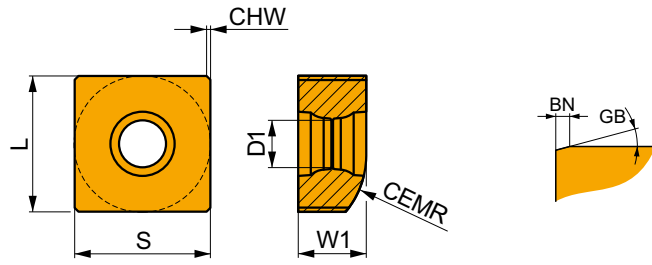

Product	W1	L	S	D1	CEMR	CHW	BN	GB	CEDC	NSIDE	7310	8215	M8310	M8325	M8326	M8330	M8340	M8345	M8346	M9315	M9325	M9340	
											(mm)	(mm)	(mm)	(mm)	(mm)	(mm)	(°)						
SNCQ 12-487001	6.35	12.700	12.700	4.4	20.0	—	0.2	15	2	1	—	—	—	●	—	—	—	—	—	—	—	—	—
S-SNCQ 12-487001	6.35	12.700	12.700	4.4	20.0	—	0.2	15	2	1	—	—	—	—	—	—	—	—	—	○	—	—	—
S-SNEX 15-001863	5.56	15.875	15.875	5.5	6.0	—	—	—	2	1	—	—	—	—	—	—	—	—	—	○	—	—	—
SNCQ 15-489006	7.94	15.875	15.875	5.5	8.0	—	0.2	15	2	1	—	—	—	—	—	—	—	—	—	○	—	—	—
S-SNCQ 15-000778	7.94	15.875	15.875	5.5	8.0	—	0.2	15	2	1	—	—	—	—	—	—	—	—	—	○	—	—	—
SNCQ 15-489001	7.94	15.875	15.875	5.5	10.0	—	0.2	15	2	1	—	—	—	—	—	—	—	—	—	●	—	—	—
SNEQ 15-2063000	7.94	15.875	15.875	5.5	10.0	0.5	—	—	2	1	—	—	—	—	—	—	—	—	—	—	—	○	—
SNCQ 15-489004	7.94	15.875	15.875	5.5	11.9	—	0.2	15	2	1	—	—	—	—	—	—	—	—	—	●	—	—	—
SNCQ 15-489003	7.94	15.875	15.875	5.5	14.0	—	0.2	15	2	1	—	—	—	—	—	—	—	—	—	○	—	—	—
S-SNCQ 15-489003	7.94	15.875	15.875	5.5	14.0	—	0.2	15	2	1	—	—	—	—	—	—	—	—	—	—	—	○	—
SNCQ 15-489005	7.94	15.875	15.875	5.5	16.0	—	0.2	15	2	1	—	—	—	—	—	—	—	—	—	○	—	—	—
S-SNCQ 15-489005	7.94	15.875	15.875	5.5	16.0	—	0.2	15	2	1	—	—	—	—	—	—	—	—	—	—	—	○	—
S-SNCQ 15-000462	7.94	15.875	15.875	5.5	22.0	—	0.2	15	2	1	—	—	—	—	—	—	—	—	—	○	—	○	—
SNCQ 15-489002	7.94	15.875	15.875	5.5	40.0	—	0.2	15	2	1	—	—	—	●	—	—	—	—	—	●	—	○	—
S-SNEX 15-001873	7.94	15.875	15.875	5.8	40.0	—	0.2	15	2	1	—	—	—	—	—	—	—	—	—	○	—	—	—

(S-)XOEX 12

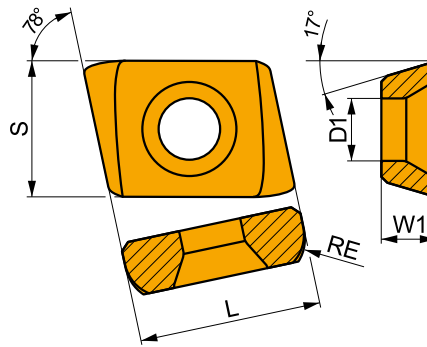

Product	W1	L	S	D1	RE	CEDC	NSIDE	7310	8215	M8310	M8325	M8326	M8330	M8340	M8345	M8346	M9315	M9325	M9340			
								(mm)	(mm)	(mm)	(mm)	(mm)										
S-XOEX 12-000013	3.8	12.7	9.450	4.4	2.8	2	1	—	—	—	—	—	—	—	—	—	○	—	—	—	—	—
XOEX 12-2355000	3.8	12.7	9.525	4.4	0.8	2	1	—	—	—	—	—	—	—	—	—	—	—	—	—	—	—

(S-)LDEX 12; 13 (CEMR)

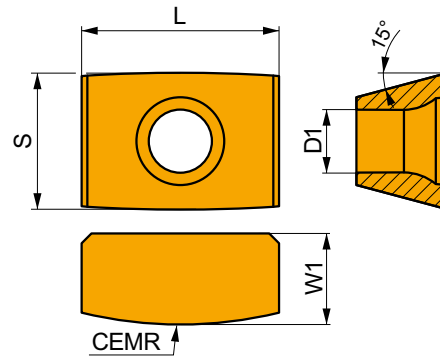

Product	W1 (mm)	L (mm)	S (mm)	D1 (mm)	CEMR (mm)	CEDC	NSIDE	7310	8215	M8310	M8325	M8326	M8330	M8340	M8345	M8346	M9315	M9325	M9340	
S-LDEX 12-1780000	3.97	12.7	7.940	3.4	-	2	1	-	-	-	-	-	-	●	-	-	-	-	-	-
LDEX 12-2102000	6.35	11.7	9.525	4.4	26.0	2	1	-	-	-	-	-	-	-	-	-	-	-	-	-
S-LDEX 12-1566000	6.35	11.7	9.525	4.4	28.0	2	1	-	-	-	-	●	-	-	-	-	-	-	-	-
S-LDEX 12-001056	4.76	12.7	9.525	4.4	15.5	2	1	-	-	-	-	-	-	-	-	-	-	-	-	-
LDEX 13-1225000	6.35	13.8	9.525	4.4	32.0	2	1	-	○	-	-	●	-	-	-	-	-	-	-	-

S-CDEW 11/(S-)XDE. 12 – 16

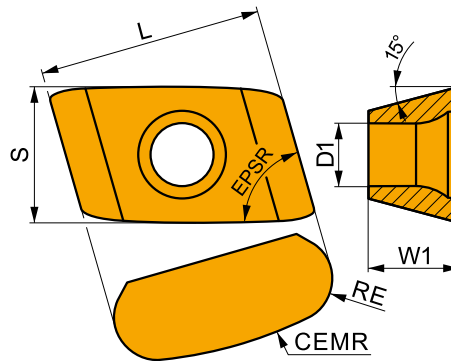

Product	W1 (mm)	L (mm)	S (mm)	D1 (mm)	RE (mm)	CEMR (mm)	EPSR (°)	CEDC	NSIDE	7310	8215	M8310	M8325	M8326	M8330	M8340	M8345	M8346	M9315	M9325	M9340
S-CDEW 11-001712	4.76	10.5	9.525	4.4	0.40	32.0	80	2	1	-	-	-	-	○	-	-	-	-	-	-	-
S-XDEW 12-001713	4.76	12.0	9.525	4.4	3.20	-	70	2	1	-	-	-	-	○	-	-	-	-	-	-	-
S-XDEX 14-1564000	6.35	14.0	9.525	4.4	3.15	26.8	74	2	1	-	-	-	-	●	-	-	-	-	-	-	-
S-XDEX 14L-1565000	6.35	14.0	9.525	4.4	3.15	26.8	74	2	1	-	-	-	-	●	-	-	-	-	-	-	-
XDEX 16-1223000	6.35	15.7	9.525	4.4	3.15	30.6	74	2	1	-	○	-	-	●	-	-	-	-	-	-	-



(S-)SN.. 12; 16 (CEMR)

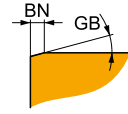
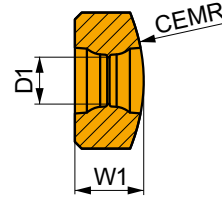
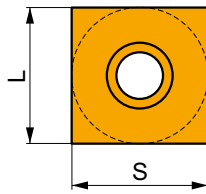

Product	W1 (mm)	L (mm)	S (mm)	D1 (mm)	CEMR (mm)	BN (mm)	GB (°)	CEDC	NSIDE	7310	8215	M8310	M8325	M8326	M8330	M8340	M8345	M8346	M9315	M9325	M9340
										—	○	—	—	—	—	—	—	—	—	—	—
SNQC 12-2500051	6.35	12.700	12.700	4.4	13.0	—	—	2	1	—	○	—	—	—	—	—	—	○	—	—	—
SNQC 12-488001	6.35	12.700	12.700	4.4	20.0	0.20	15	2	1	—	—	—	●	—	—	—	—	—	—	○	—
S-SNCQ 12-488001	6.35	12.700	12.700	4.4	20.0	0.20	15	2	1	—	—	—	—	—	—	—	—	○	—	—	—
SNQC 12-488002	6.35	12.700	12.700	4.4	80.0	0.20	15	2	1	—	—	—	—	—	—	—	—	—	—	—	—
SNQC 12-488003	6.35	12.700	12.700	4.4	150.0	0.20	15	2	1	—	—	—	—	—	—	—	—	—	—	—	—
SNXX 12-1602003	7.94	12.700	12.700	5.5	7.0	—	—	2	1	—	—	—	—	—	—	—	—	—	—	○	—
SNXX 12-1602008	7.94	12.700	12.700	5.5	10.0	—	—	2	1	—	—	—	—	—	—	—	—	—	—	○	—
SNXX 12-1602009	7.94	12.700	12.700	5.5	12.0	—	—	2	1	—	—	—	—	—	—	—	—	—	—	○	—
SNXX 12-1602000	7.94	12.700	12.700	5.5	13.0	—	—	2	1	—	—	—	—	—	—	—	—	—	—	○	—
S-SNXX 12-1602000	7.94	12.700	12.700	5.5	13.0	—	—	2	1	—	—	—	—	—	—	—	—	○	—	—	—
S-SNXX 12-000086	7.94	12.700	12.700	5.5	14.0	—	—	2	1	—	—	—	—	—	—	—	—	—	—	○	—
SNXX 12-1602001	7.94	12.700	12.700	5.5	15.0	—	—	2	1	—	—	—	—	—	—	—	—	—	—	○	—
SNXX 12-1602005	7.94	12.700	12.700	5.5	20.0	—	—	2	1	—	—	—	—	—	—	—	—	—	—	○	—
S-SNXX 12-1602005	7.94	12.700	12.700	5.5	20.0	—	—	2	1	—	—	—	—	—	—	—	—	○	—	—	—
SNXX 12-1602004	7.94	12.700	12.700	5.5	23.0	—	—	2	1	—	—	—	—	—	—	—	—	—	—	○	—
SNXX 12-1602002	7.94	12.700	12.700	5.5	25.0	—	—	2	1	—	—	—	—	—	—	—	—	—	—	○	—
SNXX 12-1602007	7.94	12.700	12.700	5.5	35.0	—	—	2	1	—	—	—	—	—	—	—	—	—	—	○	—
SNXX 12-1602006	7.94	12.700	12.700	5.5	40.0	—	—	2	1	—	—	—	—	—	—	—	—	—	—	○	—
S-SNEX 15-001868	6.35	15.875	15.875	5.5	55.0	0.25	15	2	1	—	—	—	—	—	—	—	—	○	—	—	—
SNGX 16-1667000	7.92	15.875	15.875	5.5	15.0	—	—	2	1	—	—	—	—	—	—	—	—	○	—	●	—
S-SNGX 16-1667000	7.92	15.875	15.875	5.5	15.0	—	—	2	1	—	—	—	—	—	○	—	—	—	—	—	—
SNGX 16-1667002	7.92	15.875	15.875	5.5	20.0	—	—	2	1	—	—	—	—	—	—	—	—	—	—	—	—
SNGX 16-1667001	7.92	15.875	15.875	5.5	25.0	—	—	2	1	—	—	—	—	—	—	—	—	●	—	—	—
S-SNEQ 15-000418	7.94	15.875	15.875	5.5	12.3	0.20	11	2	1	—	—	—	—	—	—	—	—	●	—	—	—
SNEQ 15-2500185	7.94	15.875	15.875	5.5	13.0	0.25	15	2	1	—	—	—	—	—	—	—	—	○	—	—	—
SNEQ 15-2501218	7.94	15.875	15.875	5.5	16.0	0.20	10	2	1	—	—	—	—	—	—	—	—	—	—	—	—
S-SNEQ 15-000454	7.94	15.875	15.875	5.5	18.0	0.25	15	2	1	—	—	—	—	—	—	—	—	○	—	○	—
SNEQ 15-2501219	7.94	15.875	15.875	5.5	20.0	0.20	10	2	1	—	—	—	—	—	—	—	—	○	—	○	—
SNEQ 15-2501220	7.94	15.875	15.875	5.5	22.0	0.20	10	2	1	—	—	—	—	—	—	—	—	—	—	○	—

● stocked ○ non-stocked — upon request



SNXN 13

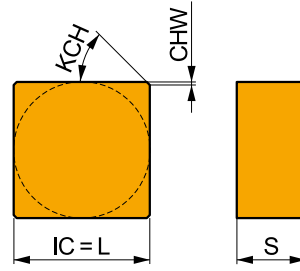

Product	IC	S	CHW	KCH	CEDC	NSIDE	7310	8215	M8310	M8325	M8326	M8330	M8340	M8345	M8346	M9315	M9325	M9340
	(mm)	(mm)	(mm)	(°)														
SNXN 13-2500361	12.975	6	0.05	45	8	2	—	—	—	—	—	—	—	—	—	○	—	—

SNEX 13; 15 (CEMR)

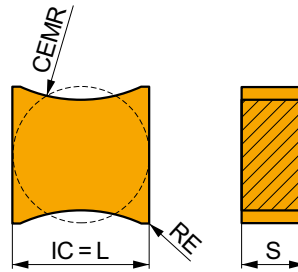

Product	IC	S	CEMR	RE	CEDC	NSIDE	7310	8215	M8310	M8325	M8326	M8330	M8340	M8345	M8346	M9315	M9325	M9340
	(mm)	(mm)	(mm)	(mm)														
SNEX 13-2501077	12.970	6	18.00	0.2	4	2	—	—	—	—	—	—	—	—	—	○	—	—
SNEX 13-2501591	12.970	6	19.33	0.2	4	2	—	—	—	—	—	—	—	—	—	○	—	—
SNEX 13-2501078	12.970	6	62.00	0.2	4	2	—	—	—	—	—	—	—	—	—	○	—	—
SNEX 15-2500362	14.975	7	16.50	0.2	4	2	—	—	—	—	—	—	—	—	—	—	—	—
SNEX 15-2500363	14.975	7	18.98	0.2	4	2	—	—	—	—	—	—	—	—	—	—	—	—
SNEX 15-2500364	14.975	7	60.00	0.2	4	2	—	—	—	—	—	—	—	—	—	—	—	—



(S-)SNEX 13 – 27

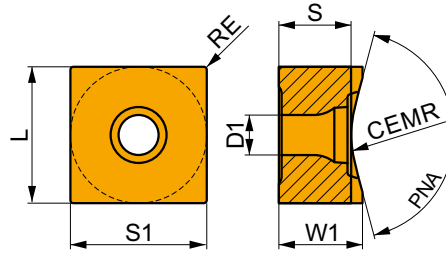

Product	W1 (mm)	L (mm)	S (mm)	S1 (mm)	D1 (mm)	CEMR (mm)	RE (mm)	PNA (°)	CEDC	NSIDE	7310	8215	M8310	M8325	M8326	M8330	M8340	M8345	M8346	M9315	M9325	M9340	
SNEX 13-2375000	6.350	13.500	6.220	13.500	4.40	150.000	0.4	-	4	1	-	-	-	-	-	-	-	-	-	-	-	-	-
SNEX 14-2386000	7.220	13.500	6.220	13.500	4.40	10.000	-	144.0	4	1	-	-	-	-	-	-	-	-	-	-	-	-	-
SNEX 14-2157000	7.220	13.500	6.290	13.500	4.40	16.500	-	154.0	4	1	-	-	○	-	-	-	-	-	-	-	-	-	-
SNEX 14-2190000	7.220	13.500	6.536	13.500	4.40	18.500	-	161.4	4	1	-	-	-	-	-	-	-	-	-	-	-	-	-
SNEX 14-2396000	8.000	13.500	7.300	13.500	5.50	16.500	0.4	160.0	4	1	-	-	-	-	-	-	-	-	-	-	-	-	-
S-SNEX 14-000979	8.000	13.500	7.318	13.500	5.50	18.650	0.4	160.7	4	1	○	-	-	-	-	-	-	-	-	-	-	-	-
S-SNEX 14-000909	8.570	14.500	7.700	14.500	5.60	19.800	0.4	155.67	4	1	○	-	-	-	-	-	-	-	-	-	-	-	-
SNEX 15-2500522	7.940	15.000	7.940	15.000	4.40	20.600	0.4	-	4	1	-	-	●	-	-	-	-	-	-	-	-	-	-
SNEX 15-2501820-R 80	8.100	15.000	7.910	15.000	4.40	83.000	0.4	175.0	4	1	-	-	-	-	-	-	-	-	-	-	-	-	-
SNEX 15-2500015	8.170	15.000	7.900	15.000	4.40	100.000	0.4	-	4	1	-	-	-	-	-	-	-	-	-	-	-	-	-
S-SNEX 15-2500169	8.280	15.000	8.280	15.000	4.40	27.800	0.4	-	4	1	●	-	-	-	-	-	-	-	-	-	-	-	-
SNEX 15-2501819-R 13	8.400	15.000	7.500	15.000	4.40	13.000	0.4	150.0	4	1	-	-	-	-	-	-	-	-	-	-	-	-	-
SNEX 15-2500014	9.130	15.000	7.937	15.000	4.40	23.500	0.4	-	4	1	-	-	-	-	-	-	-	-	-	-	-	-	-
S-SNEX 15-000953	9.140	15.000	7.940	15.000	4.40	18.000	0.4	155.0	4	1	○	-	-	-	-	-	-	-	-	-	-	-	-
SNEX 15-2500013	9.140	15.000	8.218	15.000	4.40	30.000	0.4	-	4	1	-	-	-	-	-	-	-	-	-	-	-	-	-
S-SNEX 15-000032	9.200	15.000	7.940	15.000	4.40	12.000	0.4	148.0	4	1	○	-	-	-	-	-	-	-	○	-	-	-	-
S-SNEX 15-000706	9.200	15.000	7.940	15.000	4.40	12.000	0.4	150.0	4	1	○	-	-	-	-	-	-	-	-	-	-	-	-
SNEX 15-2301000	5.790	15.875	5.450	15.875	4.40	90.000	0.4	-	4	1	-	-	-	-	-	-	-	-	-	-	-	-	-
SNEX 15-2425000	5.820	15.875	5.400	15.875	4.40	50.000	0.4	172.0	4	1	-	-	○	-	-	-	-	-	-	-	-	-	-
SNEX 15-2322000	5.870	15.875	5.485	15.875	4.40	80.000	0.4	-	4	1	-	-	-	-	-	-	-	-	-	-	-	-	-
SNEX 15-2318000	5.950	15.875	5.560	15.875	4.40	79.000	0.4	-	4	1	-	-	-	-	-	-	-	-	-	-	-	-	-
SNEX 15-2302000	5.960	15.875	5.580	15.875	4.40	80.000	0.4	-	4	1	-	-	-	-	-	-	-	-	-	-	-	-	-
SNEX 15-2224000	6.000	15.875	4.410	15.875	4.40	16.000	0.4	144.0	4	1	-	-	-	-	-	-	-	-	-	-	-	-	-
SNEX 15-2427000	6.070	15.875	4.910	15.875	4.40	16.000	0.4	159.4	4	1	-	-	○	-	-	-	-	-	-	-	-	-	-
SNEX 15-2426000	6.250	15.875	5.200	15.875	4.40	25.000	0.4	158.0	4	1	-	-	○	-	-	-	-	-	-	-	-	-	-
SNEX 15-2321000	6.350	15.875	5.050	15.875	4.40	12.000	0.4	154.0	4	1	-	-	○	-	-	-	-	-	-	-	-	-	-
SNCQ 15-2500317	6.350	15.875	5.330	15.875	5.50	13.000	0.8	-	4	1	-	-	-	-	-	-	-	-	-	-	-	-	-
S-SNEX 15-001870	6.350	15.875	5.330	15.875	5.60	13.000	0.8	-	4	1	-	-	-	-	-	-	-	-	○	-	-	-	-
SNEX 15-2225000	6.350	15.875	5.380	15.875	4.40	18.750	0.4	154.0	4	1	-	-	-	-	-	-	-	-	-	-	-	-	-
SNEX 15-2323000	6.350	15.875	5.200	15.875	4.40	20.000	0.4	158.0	4	1	-	○	-	-	-	-	-	-	-	-	-	-	-
SNCQ 15-2500318	6.350	15.875	6.200	15.875	5.50	80.000	0.8	-	4	1	-	-	-	-	-	-	-	-	-	-	-	-	-
S-SNEX 15-001871	6.350	15.875	6.200	15.875	5.60	80.000	0.8	-	4	1	-	-	-	-	-	-	-	-	○	-	-	-	-
SNEX 15-2500950	7.495	15.875	7.100	15.875	5.50	80.000	-	-	4	1	-	-	-	-	-	-	-	-	○	-	-	-	-
S-SNEX 15-001849	7.940	15.875	6.300	15.875	5.50	6.000	-	120.0	4	1	-	-	-	-	-	-	-	-	-	-	●	-	-
SNEX 15-2000000	7.940	15.875	5.350	15.875	4.90	8.475	-	-	4	1	-	-	-	○	-	-	-	-	-	-	-	-	-
SNEX 15-2000002	7.940	15.875	6.940	15.875	4.90	15.000	-	-	4	1	-	-	-	-	-	-	-	-	-	-	-	-	-
SNEX 15-2455000	7.940	15.875	6.300	15.875	4.90	15.000	-	140.0	4	1	-	-	-	-	-	-	-	-	-	-	-	-	-
SNEX 15-2424000	7.940	15.875	7.030	15.875	5.50	15.700	-	159.5	4	1	-	-	-	-	-	-	-	-	○	-	-	-	-
S-SNEX 15-2424000	7.940	15.875	7.030	15.875	5.50	15.700	-	159.5	4	1	○	-	-	-	-	-	-	-	-	-	-	-	-
SNEX 15-2000003	7.940	15.875	7.440	15.875	4.90	35.000	-	-	4	1	-	-	-	-	-	-	-	-	○	-	-	-	-
SNEX 27-1900000	13.30	27.000	8.520	27.000	9.12	15.000	0.8	124.0	4	1	-	-	-	-	-	-	-	-	-	-	-	-	-



(S-)SP.X 12 – 27

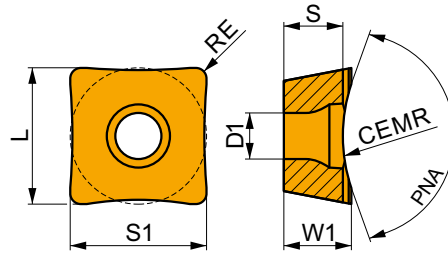

Product	W1 (mm)	L (mm)	S (mm)	S1 (mm)	D1 (mm)	CEMR (mm)	RE (mm)	PNA (°)	CEDC	NSIDE	7310	8215	M8310	M8325	M8326	M8330	M8340	M8345	M8346	M9315	M9325	M9340	
SPEX 12-2003004	6.35	12.700	–	12.700	4.40	0.00	0.8	–	4	1	–	–	○	–	–	–	–	–	–	–	–	–	○
SPEX 12-2003001	6.35	12.700	4.91	12.700	4.40	2.00	0.8	110.0	4	1	–	–	–	–	–	–	–	–	–	–	–	–	–
SPEX 12-2003002	6.35	12.700	5.13	12.700	4.40	3.00	0.8	110.0	4	1	–	–	–	○	–	–	–	–	–	–	–	–	–
SPEX 12-1646000	6.35	12.700	5.35	12.700	4.40	4.00	0.8	134.0	4	1	–	–	–	–	–	–	–	–	–	–	–	–	–
SPEX 12-2003000	6.35	12.700	5.35	12.700	4.40	4.00	0.8	110.0	4	1	–	–	–	–	–	–	–	–	–	–	–	–	–
SPEX 12-2003012	6.35	12.700	5.19	12.700	4.40	5.00	0.8	120.0	4	1	–	–	–	–	–	–	–	–	–	–	–	–	–
S-SPEX 12-1646001	6.35	12.700	5.35	12.700	4.40	5.00	0.8	134.0	4	1	–	–	–	–	–	–	○	–	○	–	–	–	–
SPEX 12-2003011	6.35	12.700	4.85	12.700	4.40	6.00	0.8	130.0	4	1	–	–	–	–	–	–	–	–	–	–	–	–	–
SPEX 12-1646003	6.35	12.700	5.35	12.700	4.40	6.50	0.8	140.0	4	1	–	–	–	–	–	–	–	–	–	–	–	–	–
S-SPEX 12-1646002	6.35	12.700	5.35	12.700	4.40	8.00	0.8	134.0	4	1	–	–	–	–	–	–	–	–	○	–	–	–	–
SPEX 12-2003006	6.35	12.700	5.05	12.700	4.40	10.00	0.8	134.7	4	1	–	–	–	–	–	–	–	–	–	–	–	○	–
SPEX 12-2003007	6.35	12.700	5.45	12.700	4.40	13.00	0.8	143.0	4	1	–	–	–	–	–	–	–	–	–	●	–	–	–
SPEX 12-2003005	6.35	12.700	5.55	12.700	4.40	15.00	0.8	149.5	4	1	–	–	–	–	–	–	–	–	–	–	–	–	–
SPEX 12-2003008	6.35	12.700	6.20	12.700	4.40	80.00	0.8	–	4	1	–	–	–	–	–	–	–	–	○	–	–	–	–
SPEX 12-2003003	7.25	13.050	5.75	13.050	4.40	5.00	0.8	100.0	4	1	–	–	–	–	–	–	–	–	–	–	–	–	–
SPEX 12-2003009	7.25	13.050	5.65	13.050	4.40	5.00	0.8	140.0	4	1	–	–	–	–	–	–	–	–	–	–	–	–	–
SPEX 15-1522001	7.94	15.875	7.24	15.875	5.50	30.00	0.8	158.0	4	1	–	–	–	–	–	–	–	–	–	–	–	–	–
SPEX 15-1522002	7.94	15.875	7.50	15.875	5.50	40.00	0.8	–	4	1	–	–	–	–	–	–	–	–	–	–	–	–	–
SPEX 15-1522003	7.94	15.875	7.74	15.875	5.50	80.00	0.8	–	4	1	–	–	–	–	–	–	–	–	–	–	–	–	–
SPGX 19-2280000	8.60	19.000	6.35	19.000	6.70	15.78	0.4	131.0	4	1	–	–	–	–	–	–	–	–	–	–	–	–	–
S-SPGX 19-000968	8.60	19.000	6.60	19.000	6.70	17.00	1.0	131.0	4	1	○	–	–	–	–	–	–	–	–	–	–	–	–
SPEX 27-2161000	13.30	27.085	8.45	27.085	9.12	15.00	0.8	124.0	4	1	–	–	–	–	–	–	–	–	–	–	–	–	–



(S-)SN.Q 15

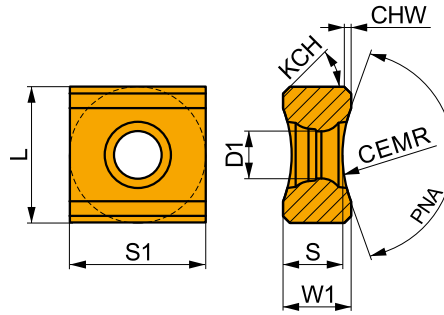

Product	W1	L	S	S1	D1	CEMR	PNA	CHW	KCH	CEDC	NSIDE	7310	8215	M8310	M8325	M8326	M8330	M8340	M8345	M8346	M9315	M9325	M9340	
	(mm)	(mm)	(mm)	(mm)	(mm)	(mm)	(°)	(mm)	(°)															
S-SNEQ 15-001652	7.94	15.875	6.90	15.875	5.5	8.00	140	0.5	45	4	2	—	—	—	—	—	—	—	—	—	○	—	—	—
S-SNCQ 15-510001	7.94	15.875	6.94	15.875	5.5	10.00	—	—	—	4	2	—	—	—	—	—	—	—	—	—	○	—	○	—
SNEQ 15-2064001	7.94	15.875	6.94	15.875	5.5	12.70	—	0.5	45	4	2	—	—	—	—	—	—	—	—	—	—	—	—	—
SNCQ 15-1806000	7.94	15.875	6.56	15.875	5.5	13.00	141	—	—	4	2	—	—	—	—	—	—	—	—	—	—	—	—	—
SNCQ 15-510002	7.94	15.875	6.94	15.875	5.5	13.00	—	—	—	4	2	—	—	●	—	—	—	—	—	●	—	○	—	—
S-SNEQ 15-2064000	7.94	15.875	7.19	15.875	5.5	15.00	—	0.5	45	4	2	—	—	—	—	—	—	—	—	—	○	—	—	—
SNCQ 15-510003	7.94	15.875	6.94	15.875	5.5	15.25	—	—	—	4	2	—	—	—	—	—	—	—	—	—	○	—	—	—
S-SNCQ 15-510003	7.94	15.875	6.94	15.875	5.5	15.25	—	—	—	4	2	—	—	—	—	—	—	—	—	—	—	○	—	—
S-SNCQ 15-000484	7.94	15.875	7.70	15.875	5.5	80.00	—	—	—	4	2	—	—	—	—	—	—	—	—	—	○	—	—	—

S-LNEX 15

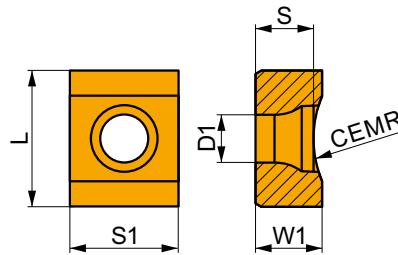

Product	W1	L	S	S1	D1	CEMR	CEDC	NSIDE	7310	8215	M8310	M8325	M8326	M8330	M8340	M8345	M8346	M9315	M9325	M9340		
	(mm)	(mm)	(mm)	(mm)	(mm)	(mm)																
S-LNEX 15-001853	7.8	15.875	6.8	12.7	5.65	13	2	1	—	—	—	—	—	—	—	—	—	○	—	—	—	—
S-LNEX 15-001854	7.8	15.875	7.6	12.7	5.65	80	2	1	—	—	—	—	—	—	—	—	—	○	—	—	—	—



(S-)LPGX 27

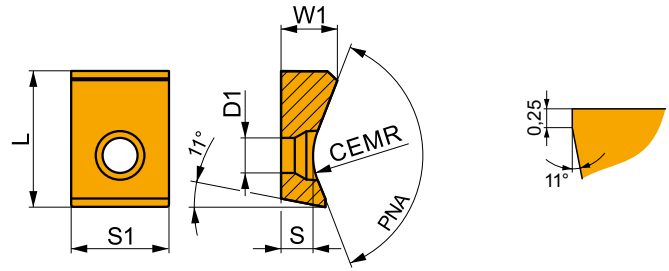

Product	W1	L	S	S1	D1	CEMR	PNA	CEDC	NSIDE	7310	8215	M8310	M8325	M8326	M8330	M8340	M8345	M8346	M9315	M9325	M9340	
	(mm)	(mm)	(mm)	(mm)	(mm)	(mm)	(°)															
LPGX 27-2351000	11.22	25.36	6.35	18.953	6.7	13.2	135.50	2	1	—	—	—	—	—	—	—	—	—	—	—	—	—
S-LPGX 27-1903000	10.91	26.337	6.35	18.953	6.7	15.5	135.00	2	1	○	—	—	—	—	—	—	—	—	—	—	—	—
LPGX 27-2501570	11.28	26.337	6.35	18.953	6.7	16.4	129.15	2	1	—	—	○	—	—	—	—	—	—	—	—	—	—

(S-)SP.W 14 – 19

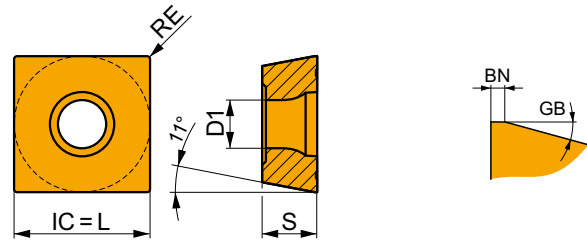

Product	IC	S	D1	RE	BN	GB	CEDC	NSIDE	7310	8215	M8310	M8325	M8326	M8330	M8340	M8345	M8346	M9315	M9325	M9340	
	(mm)	(mm)	(mm)	(mm)	(mm)	(°)															
SPEW 14-2162000	14.280	6.35	4.4	0.0	—	—	4	1	—	—	—	—	—	—	—	—	—	—	—	—	—
S-SPGW 15-1906000	15.875	6.35	5.5	0.5	0.25	0	4	1	○	—	—	—	—	—	—	—	—	—	—	—	—
SPGW 15-2500368	15.875	6.35	5.5	0.8	0.20	0	4	1	—	—	—	—	—	—	—	—	—	—	—	—	—
SPMW 19-1904000	19.050	6.35	6.6	0.4	0.15	15	4	1	—	—	—	—	—	—	—	—	—	—	—	—	—
S-SPGW 19-1905000	19.050	6.35	6.6	0.1	0.15	15	4	1	—	—	—	—	—	—	—	—	—	—	—	—	○



S-SPEN 12

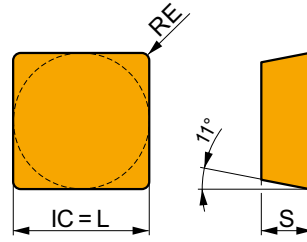

Product	IC	S	RE	CEDC	NSIDE	7310	8215	M8310	M8325	M8326	M8330	M8340	M8345	M8346	M9315	M9325	M9340	
	(mm)	(mm)	(mm)			(mm)												
S-SPEN 120408	12.7	4.76	0.8	4	1	—	●	○	—	—	—	—	—	—	—	—	—	—

S-SPEN 12; 15

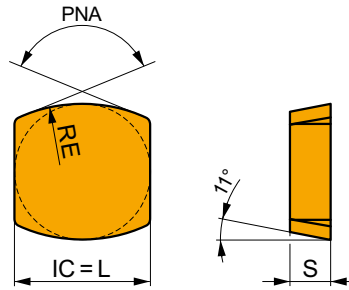

Product	IC	S	RE	PNA	CEDC	NSIDE	7310	8215	M8310	M8325	M8326	M8330	M8340	M8345	M8346	M9315	M9325	M9340
	(mm)	(mm)	(mm)	(°)														
S-SPEN 12-000987	12.700	4.76	20.00	150	2	1	—	○	—	—	—	—	—	—	—	—	—	—
S-SPEN 15-000780	15.875	4.76	7.00	112	2	1	—	○	—	—	—	—	—	—	—	—	—	—
S-SPEN 15-000859	15.875	4.76	8.00	—	4	1	—	○	—	—	—	—	—	—	—	—	—	—
S-SPEN 15-000988	15.875	4.76	11.50	100	2	1	—	○	—	—	—	—	—	—	—	—	—	—
S-SPEN 15-001205	15.875	4.76	12.70	—	2	1	—	○	—	—	—	—	—	—	—	—	—	—
S-SPEN 15-000856	15.875	4.76	16.00	—	2	1	—	○	—	—	—	—	—	—	—	—	—	—
S-SPEN 15-000595	15.875	4.76	18.00	132	2	1	—	○	—	—	—	—	—	—	—	—	—	—
S-SPEN 15-001108	15.875	4.76	19.05	—	2	1	—	○	—	—	—	—	—	—	—	—	—	—
S-SPEN 15-000857	15.875	4.76	22.00	—	2	1	—	○	—	—	—	—	—	—	—	—	—	—



S-RPGN 20

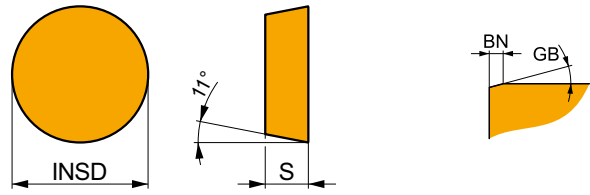

Product	INSD	S	BN	GB	NSIDE	7310	8215	M8310	M8325	M8326	M8330	M8340	M8345	M8346	M9315	M9325	M9340
	(mm)	(mm)	(mm)	(°)													
S-RPGN 20-000606	20	6.35	0.17	10	1	—	○	—	—	—	—	—	—	—	—	—	—

(S-)LC 16 – 32

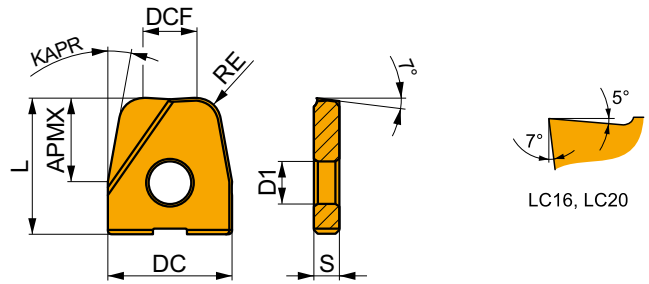

Product	DC	L	S	D1	RE	APMX	DCF	KAPR	CEDC	NSIDE	7310	8215	M8310	M8325	M8326	M8330	M8340	M8345	M8346	M9315	M9325	M9340
	(mm)	(mm)	(mm)	(mm)	(mm)	(mm)	(mm)	(°)														
LC 16-2381000-R3	15	16	3	5	3.00	9.9	11.5	1:6	2	2	—	—	—	—	—	—	—	—	—	—	—	—
LC 20-2382000-R3	20	18	3	5	3.00	16.0	16.0	1:6	2	2	—	—	—	—	—	—	—	—	—	—	—	—
S-LC 32-001510	32	28	5	8	0.25	12.5	9.5	47	2	2	—	—	—	—	—	—	—	—	—	—	—	—



(S-)LC 32

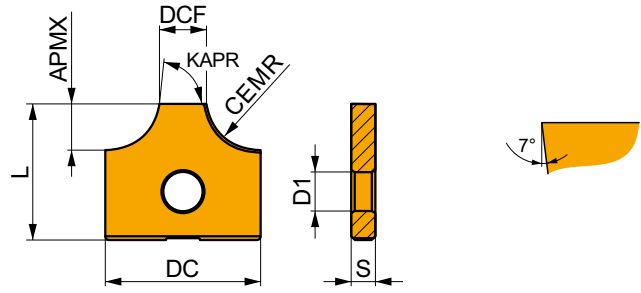

Product	DC (mm)	L (mm)	S (mm)	D1 (mm)	CEMR (mm)	APMX (mm)	DCF (mm)	KAPR (°)	CEDC	NSIDE	7310	8215	M8310	M8325	M8326	M8330	M8340	M8345	M8346	M9315	M9325	M9340	
											—	—	—	—	—	—	—	—	—	—	—	—	—
S-LC 32 R6-000424	32	28	5	8	6.04	6.06	17.83	80	2	2	—	—	—	—	—	—	—	—	—	—	—	—	—
LC 32-2383000-R6	32	28	5	8	6.25	4.36	18.24	62	2	2	—	—	—	—	—	—	—	—	—	—	—	—	—
LC 32-2385000-R10	32	28	5	8	10.50	9.49	10.89	78	2	2	—	—	—	—	—	—	—	—	—	—	—	—	—
LC 32-2384000-R13	32	28	5	8	14.40	11.95	6.96	75	2	2	—	—	—	—	—	—	—	—	—	—	—	—	—

RNGX 12

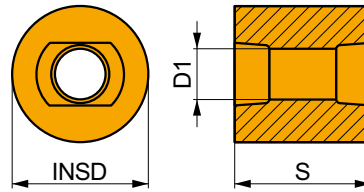

Product	INSD	S	D1	NSIDE	S30	7330
	(mm)	(mm)	(mm)			
RNGX 1212MO	12.000	12.000	4.4	2	○	○



ROEX 15

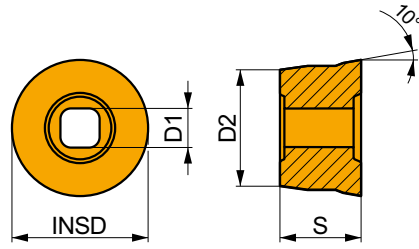

Product	INSD (mm)	S (mm)	D1 (mm)	D2 (mm)	NSIDE	S30	7330
ROEX 1509MOEN	15.9	9.525	4.6	14.65	1	●	—
ROEX 15-2501908	15.9	9.525	4.6	14.65	1	—	○

S-RNEX 15

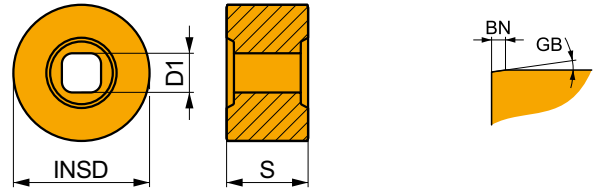

Product	INSD (mm)	S (mm)	D1 (mm)	BN (mm)	GB (°)	NSIDE	HF10	S30
S-RNEX 15-001309	15.875	9.525	4.6	0.24	20°30'	2	○	○

S-RNEX 16

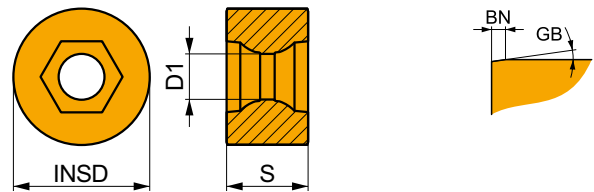

Product	INSD (mm)	S (mm)	D1 (mm)	BN (mm)	GB (°)	NSIDE	8215	S30
S-RNEX 16-000710	16.00	9.525	5.4	0.24	20°30'	2	○	—



GENERAL TECHNICAL INFORMATION





7		INTRODUCTION & ASSORTMENT HIGHLIGHTS	
13	RAILWAY INDUSTRY	PRODUCTION OF NEW RAILWAY WHEELS	
20		RAILWAY WHEEL RECONDITIONING	
26		AXLES MACHINING	
30		STATIONARY & DYNAMIC RAIL MILLING	
37		TURNOUTS MACHINING	
57		BASE PLATES MACHINING	
63		WAGON & BOGIE PARTS MACHINING	
73		TURNING ASSORTMENT	INSTRUCTIONS & NAVIGATORS
88			POSITIVE INSERTS
107	NEGATIVE INSERTS		
146		INDEXABLE MILLS	
166		TECHNICAL PART	



TURNING GRADES



Operation

Coating/Substrate

Generation

ISO range



D	Drilling
M	Milling
T	Turning
G	Grooving and Parting off

0 PVD 1 CVD	Special application
2 PVD 3 CVD	Free
4 PVD 5 CVD	Group K, H
6 PVD 7 CVD	Group M, S
8 PVD 9 CVD	Universal
B	CBN
C	Ceramic
D	PCD
T	Cermet

1 - 9

01 - 50	
	01 - 05
	05 - 10
	10 - 20
	20 - 30
	30 - 40
	40 - 50



TURNING GRADES

Grade Identification	Area of Application	Application	Feed	Cutting speed	Resistance to adverse Working Conditions	Coating	Colour	Substrate	Coolant benefit	Grade description
T9226	P15 - P35	■				MT-CVD	Yellow	FGM	+++	Grade designed for heavy roughing applications. A versatile grade with high resistance to mechanical damage and retains very good wear resistance. Usable at lower cutting speeds.
	M10 - M30	■								
	K15 - K35	■								
	S15 - S25	□								
T9310	P01 - P15	■				MT-CVD	Black	FGM	++	Grade with high abrasion resistance which can be used for slightly interrupted cutting. It will be used for finishing or semi-roughing operations. This material can also be used for roughing operations provided the machine-tool-workpiece configuration is sufficiently rigid.
	K05 - K20	■								
	H10 - H20	■								
T9315	P05 - P25	■				MT-CVD	Black	FGM	++	A versatile grade with excellent wear resistance properties even under intense cutting conditions. It can also be used for operations with interrupted cuts. With its well balanced properties this grade can be first choice for a wide range of turning operations. Not suited to low cutting speeds.
	K05 - K25	■								
	H10 - H20	■								
T9316	P10 - P20	■				MT-CVD	Yellow	FGM	+++	Grade designed for railway applications. A versatile grade with excellent wear resistance properties. Usable at lower and high cutting speeds.
	M05 - M15	■								
	K10 - K30	■								
	H15 - H25	■								
T9325	P15 - P35	■				MT-CVD	Black	FGM	++	From a technological perspective this is an extremely versatile grade with high resistance to mechanical damage in adverse cutting conditions and retains excellent wear resistance. The correct application of this material requires high cutting speeds.
	M10 - M30	■								
	K15 - K35	■								
	S10 - S20	■								
T9335	P20 - P45	■				MT-CVD	Black	FGM	+++	One of the toughest grades which is especially suitable for adverse cutting conditions at medium to high feed rates and medium cutting speeds. Compared to its predecessors, M15 - M40 it is not only tougher, but also more abrasion resistant which will be useful when using intensive cutting conditions.
	M15 - M40	■								
	S15 - S25	■								
T7325	P15 - P35	■				MT-CVD	Black	FGM	+++	One of the most universal turning grades. Especially designed for stainless steel machining. Optimal balance between wear resistance and performance reliability. Suitable for broad variety of application in turning operations.
	M10 - M25	■								
	S10 - S25	■								
T7335	P20 - P40	■				MT-CVD	Black	FGM	+++	Grade with functionally graded substrate, featuring very high operational reliability and very good wear-resistance. It is best suited to use in the machining of very tough M20 - M40 materials.
	M20 - M40	■								
	S15 - S25	■								
T5305	P05 - P15	■				MT-CVD	Black	H	+	Grade with very high resistance to chemical wear; suitable for finishing operations using high cutting speeds. With its high abrasion resistance, it is also suitable for productive K01 - K15, machining of hardened and treated materials.
	K01 - K15	■								
	H05 - H15	■								
T5315	P10 - P25	■				MT-CVD	Black	H	+	Grade intended primarily for productive machining which has high abrasion resistance and good operational reliability. Due to its properties, this material is particularly suitable for roughing and finishing operations for good or slightly adverse cutting conditions.
	K10 - K25	■								
	H15 - H25	■								
6630	P10 - P35	■				MT-CVD	Yellow	FGM	+++	A versatile turning material which is particularly suitable for applications with medium to low cutting speeds and medium to higher feed rates. It is an ideal first choice for conventional machines. It can be used for semi-roughing, but also for roughing and finishing operations
	M22 - M32	■								
	K22 - K30	■								
6640	P20 - P40	■				MT-CVD	Yellow	H	+++	One of the toughest turning materials which can be used especially in roughing operations, or where operational reliability under adverse cutting conditions is a priority. Another ideal choice for machines working with low to medium cutting speeds and medium to high feed rates.
	M20 - M35	■								
	K25 - K40	■								



TURNING GRADES

Grade Identification	Area of Application	Application	Feed	Cutting speed	Resistance to adverse Working Conditions	Coating	Colour	Substrate	Coolant benefit	Grade description
T6310	P01 - P15	■				PVD	grey	ultra submicron H	+++	High wear resistant turning grade with top PVD coating. Suitable for finishing operation and applications, where sharp cutting edge together with high flank wear resistance is of high importance
	M01 - M15	■								
	K05 - K20	■								
	N05 - N20	■								
	S01 - S15	■								
	H01 - H15	■								
T8315	P05 - P20	☑				PVD	yellow	submicron H	++	Grade featuring excellent abrasion resistance while maintaining above average operational reliability, it is suitable for machining at medium to high cutting speeds in short chipping harder materials.
	M05 - M20	■								
	K05 - K25	■								
	N05 - N25	■								
	S05 - S15	☑								
	H05 - H15	■								
T8430 NEW	P20 - P40	■				PVD	brown	submicron H	+++	Undoubtedly the most versatile cutting material, this is useful for machining of all types of machined materials and is practically applicable in almost all types of turning operations. Its main benefits are its high operational reliability and very good frictional properties; it is therefore suitable for applications at medium and lower cutting speeds.
	M20 - M35	■								
	K25 - K40	☑								
	N15 - N30	☑								
	S15 - S25	☑								
	H15 - H25	☑								
T8345	P30 - P50	■				PVD	yellow	submicron H	+++	This is the toughest turning grade, which is intended mainly for machining under the worst cutting conditions and in applications with the highest requirements for operating reliability. Because of these properties, this material is recommended for lower cutting speeds.
	M20 - M40	☑								
	K30 - K40	☑								
	S20 - S30	☑								
HF7	M10 - M20	☑				-	grey	submicron H	++	Uncoated grade which is primarily designed for machining non-ferrous metals; but can also be used for other machined materials (except steel). This material can be used in turning, milling, and even boring.
	K10 - K25	■								
	N10 - N25	■								



MILLING GRADES

Grade Identification	Area of Application	Application	Feed	Cutting speed	Resistance to adverse Working Conditions	Coating	Colour	Substrate	Coolant benefit	Grade description
M9315	P05 – P25	■				MT-CVD	Black	H	---	Milling grade with high abrasion resistance even at high thermal loads, main application area is higher cutting speeds with medium or small depths of cut.
	K10 – K30	■								
	H10 – H20	■								
M9325	P10 – P30	■				MT-CVD	Black	H	---	This grade has an ideal balance between wear resistance and toughness, it is mainly designed for roughing operations. Advantages are excellent wear resistance even at relatively high cutting speeds with excellent reliability, this grade is more suitable for applications using higher speeds and lower feed rates.
	K10 – K30	■								
	H15 – H20	■								
M9340	P35 – P50	■				MT-CVD	Black	H	---	A very tough grade, where the main advantage is the high strength of the cutting edge and resistance to adverse cutting conditions. Although this material has an MT-CVD M30 – M40 coating, it is possible to use emulsion cooling for its application, especially in optimum cutting conditions.
	M30 – M40	■								
	S15 – S20	■								
M5315	P05 – P20	■				MT-CVD	Black	H	---	One of the most abrasion-resistant milling grades which should be used under stable conditions. Its main advantage is the extremely high resistance to thermal stress and abrasive K05 – K25 wear. It is mainly used for machining hard and very hard materials, particularly cast iron.
	K05 – K25	■								
	H05 – H20	■								
M8310	P01 – P10	■				PVD	Dark Purple	ultra submicron H	-	Grade specially developed for copy milling, featuring high resistance to abrasion. It is suitable for machining at higher cutting speeds under stable cutting conditions, and for machining virtually all groups of machined materials (particularly stronger and harder materials).
	M01 – M10	■								
	K01 – K10	■								
	H05 – H15	■								
8215	P10 – P20	■				PVD	Yellow	submicron H	+ / -	One of the most versatile milling grades, in terms of both the range of workpiece materials and the range of possible applications. It is characterised by high wear resistance and operational reliability. Its other advantages include excellent resistance to cracking induced by temperature shock. With its unique properties, this material is undoubtedly one of the pillars of the milling range.
	M10 – M20	■								
	K10 – K25	■								
	N10 – N25	■								
	S10 – S15	■								
M8325	P20 – P40	■				PVD	Dark Purple	S	-	The main application area of this grade is machining all kinds of steels (including stainless) in the "soft state". It can also be used for machining softer cast irons. Suitable for M15 – M30 machining at medium speeds under average cutting conditions.
	M15 – M30	■								
M8330	P20 – P40	■				PVD	Yellow	submicron H	+ / -	This grade is universal and can be used for machining various types of materials. However, it's priority application area lies within steels and ductile cast irons. It is recommended for milling at medium speeds under unstable cutting conditions.
	M20 – M35	■								
	K20 – K40	■								
	N15 – N30	■								
	S15 – S25	■								
M8340	P25 – P50	■				PVD	Yellow	submicron H	+ / -	One of the toughest grade dedicated for machining with lower cutting speed and unfavorable conditions. This grade is ideal for all operations where the main requirement is for a tough cutting edge.
	M20 – M40	■								
	K20 – K40	■								
	S20 – S30	■								



MILLING GRADES

Grade Identification	Area of Application	Application	Feed	Cutting speed	Resistance to adverse Working Conditions	Coating	Colour	Substrate	Coolant benefit	Grade description
M8345	P30 – P50	■				PVD	Dark Purple	H	-	This grade has exceptional operational reliability and is designed for heavy cuts in unfavourable conditions in difficult and tough materials.
	M30 – M40	■								
M6330	P20 – P35	■				PVD	Yellow	H	+ / -	Milling grade with extraordinary service reliability. Especially suitable for machining of hard to machine materials. Powerful in applications where unfavourable conditions and heavy cuts dominate.
	M20 – M35	■								
	S20 – S30	■								
M4303	P01 – P10	▣				PVD	Dark Grey	ultra submicron H	-	The most wear resistant grade for mold & die applications. Offers exceptional performance at high cutting speeds and low feeds in stable cutting conditions. Suitable for finishing operations in difficult workpiece materials.
	K01 – K10	■								
	N01 – N10	▣								
M8326	P20 – P40	■				PVD	Dark Purple	H	-	Special grade for heavy duty. The main application area of this grade is machining all kinds of steels (including stainless) in the „soft state“. It can also be used for machining softer cast irons. Suitable for M15 – M30 machining at medium speeds under average cutting conditions.
	M15 – M30	▣								
M8346	P30 – P50	■				PVD	Dark Purple	H	-	Special grade for heavy duty. This grade has exceptional operational reliability and is designed for heavy cuts in unfavourable conditions in difficult and tough materials.
	M30 – M40	■								
7310	P01 – P10	■				PVD	Yellow	ultra submicron H	-	One of the most abrasion-resistant materials, it is highly versatile and finds its application especially in finishing operations, i.e. at high cutting speeds and small chip cross-sections taken under ideal cutting conditions. The ideal choice for machining hard to very hard materials.
	M01 – M10	▣								
	K01 – K10	■								
7330	P20 – P35	■				PVD	Dark Purple	submicron H	-	A very versatile material suitable for finishing as well as for semi-roughing operations. It is a material which, while maintaining very good abrasion resistance, also retains very good operational reliability.
	M20 – M30	▣								
	K20 – K30	■								
	H15 – H20	▣								
HF7	M10 – M20	▣				-	Dark Grey	ultra submicron H	++	Uncoated grade which is primarily designed for machining non-ferrous metals; can also be used for other machined materials (except steel). This grade can be used in turning, milling, and even boring.
	K10 – K25	■								
	N10 – N25	■								
S30	P25 – P30	■				-	Grey	S	+ / -	Uncoated material with good resistance to cratering. It is designed exclusively for machining carbon and alloy steels at low cutting speeds.

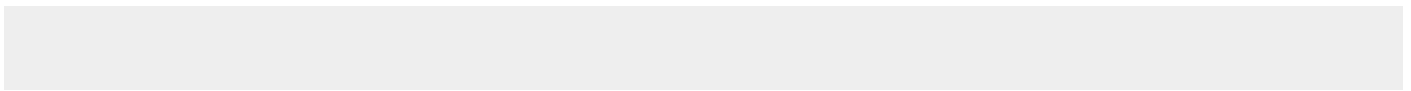

Substrate	
H	WC-Co based substrate
submicron H	WC-Co based substrate fine grained (< 1 μm)
ultra submicron H	WC-Co based substrate very fine grained (< 0,5 μm)
S	Substrate with cubic carbides
FGM	Functionally graded substrate
Cermet	Cemented carbide without WC
ceramics	Cutting ceramics
PCD	Polycrystalline Diamond
CBN	Cubic Boron Nitride
HSS	High speed steel

Coating	
MT-CVD	Medium-temperature chemical method of coating
PVD	Low-temperature physical method of coating
-	Uncoated grade

Coolant benefit - Turning	
+++	Use of coolant is essential
++	Highly recommended
+	Recommended
+/-	Optional
--	Do not use coolant
-	Coolant not recommended

Coolant benefit - Milling

---	Very negative effect on tool life – cooling is not recommended
-	Slightly negative effect on tool life
+/-	Influence of cooling may be both positive and negative – decisive factor is specific working conditions
++	Positive effect on tool life – cooling is recommended

Level of influence





TYPES OF TRANSPORT RAILS

TYPE A

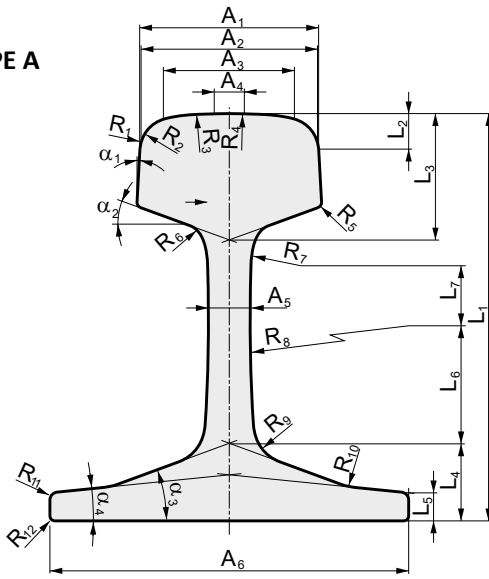

TYPE B

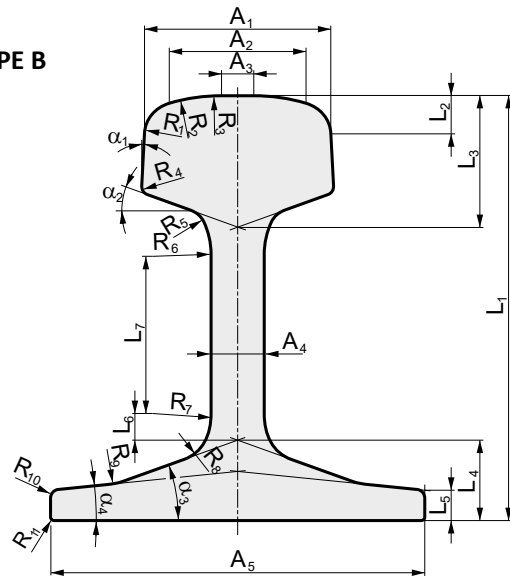

PROFILE	46E1	46E2	46E3	46E4	49E1	49E2	49E5	50E1	50E2	50E3	50E4	50E5	50E6	52E1	54E1	54E2	54E3
Former designation	SBB I	U33	NP 46	46 UNI	DIN 549	S49 T	-	U50E	50EB-T	BV 50	UIC 50	50 UNI	U 50	52 RATP	UIC 54	UIC 54 E	DIN 554
Rail profile type	C	B	C	C	A	A	A	B	B	A	A	A	B	A	A	A	A
A ₁ (mm)	65	62	73.72	65	67	67	67	65	72	70	70	67	65	65	70	67	67
A ₂ (mm)	-	40.588	-	-	-	-	66	43.838	52.053	-	-	-	43.838	-	-	-	-
A ₃ (mm)	43.881	27.946	53.761	-	46.835	-	62.98	30.942	20.456	49.982	49.727	-	30.942	-	49.727	46.31	46.835
A ₄ (mm)	18.881	15	23.015	38.378	15.267	40.471	41.342	15.5	15	18.233	20.025	40.471	15.5	42.456	20.024	18.946	15.267
A ₅ (mm)	16	134	-	16	14	14	14	134	140	14	15	14	140	15	16	16	16
A ₆ (mm)	14	-	14	14	125	125	125	-	-	133	125	135	-	150	140	125	125
A ₇ (mm)	18	-	-	18	-	-	-	-	-	-	-	-	-	-	-	-	-
A ₈ (mm)	125	-	120	135	-	-	-	-	-	-	-	-	-	-	-	-	-
L ₁ (mm)	145	145	142	145	149	148	149	153	151	155	152	148	153	150	159	161	154
L ₂ (mm)	14.3	13.42	14.18	13.75	14	13.62	14.28	13.58	14.3	14.23	14.1	13.62	13.58	-	14.1	13.85	14
L ₃ (mm)	45	47	42.5	45	51.5	50.5	51.5	49	44	48	49.4	50.5	49	55	49.4	51.4	55
L ₄ (mm)	25	27	25	25	27.5	27.5	27.5	28	28	27	28	27.5	28	32	30.2	30.2	29
L ₅ (mm)	-	10.5	-	-	10.5	10.5	10.5	11.5	11.13	10	10	10	11.2	10	11	12	12
L ₆ (mm)	64.45	-	55	52.5	24.5	24.5	24.5	-	10	48	47.1	24.5	-	43	46	46	46
L ₇ (mm)	53.65	-	30	30	30	30	30	-	59	-	18.6	30	-	-	-	-	-
L ₈ (mm)	-	-	-	-	-	-	-	-	-	-	-	-	-	-	-	-	-
L ₉ (mm)	-	-	-	-	-	-	-	-	-	-	-	-	-	-	-	-	-
R ₁ (mm)	13	13	13	14	13	14	7.64	13	13	13	13	14	13	12	13	13	13
R ₂ (mm)	-	60	-	-	-	-	15.5	60	80	-	-	-	60	-	-	-	-
R ₃ (mm)	80	200	80	-	80	-	16.5	200	300	80	80	-	200	-	80	80	80
R ₄ (mm)	300	2	300	400	300	400	115	2	2	300	300	400	2	350	300	300	300
R ₅ (mm)	1	7	1.5	1	2	2	2	12	8	2	3	2	12	5	3	2	5
R ₆ (mm)	6	-	6	5	7	7	7	-	30.81	7	8	7	-	12	8	8	16
R ₇ (mm)	-	-	-	-	80	80	80	-	30.81	-	22	80	-	400	22	22	-
R ₈ (mm)	30	7	80	-	120	120	120	12	8	450	508	120	12	600	508	508	500
R ₉ (mm)	30	20	120	-	-	-	-	20	10	-	-	-	20	-	-	-	-
R ₁₀ (mm)	6	3	6	5	-	-	-	3	5	-	-	-	3	-	-	-	-
R ₁₁ (mm)	2	2	3	2	2	2	2	2	2	2	2	2	2	2	2	2	2
R ₁₂ (mm)	1	-	1	1	-	-	-	-	-	-	-	-	-	-	-	-	-
R ₁₃ (mm)	-	-	-	-	3	3	3	-	-	3	3	3	-	4	3	3	3
R ₁₄ (mm)	-	-	-	-	1.5	1.5	2	-	-	1	2	2	-	3	2	2	2
α ₁ (°)	0°	1:20 2°51'45" 2.8624°	1:16.5 3°28'6" 3.4682°	1:20 2°51'45" 2.8624°	1:17.2 3°19'39" 3.3274°	1:16 3°34'35" 3.576°	1:17.2 3°19'39" 3.3274°	1:20 2°51'45" 2.8624°	1:20 2°51'45" 2.8624°	1:20 2°51'45" 2.8624°	1:20 2°51'45" 2.8624°	1:16 3°34'35" 3.3576°	1:20 2°51'45" 2.8624°	0°	1:20 2°51'45" 2.8624°	1:20 2°51'45" 2.8624°	1:17.2 3°19'39" 3.3274°
α ₂ (°)	14°21'0" 14.0362°	18°26'06" 18.4349°	14°21'0" 14.0362°	14°21'0" 14.0362°	18°26'06" 18.4349°	18°26'06" 18.4349°	18°26'06" 18.4349°	18°26'06" 18.4349°	18°26'06" 18.4349°	18°26'06" 18.4349°	18°26'06" 18.4349°	19°58'59" 19.983°	18°26'06" 18.4349°	26°33'54" 26.565°	19°58'59" 19.983°	19°58'59" 19.983°	18°26'06" 18.4349°
α ₃ (°)	14°21'0" 14.0362°	18°26'06" 18.4349°	14°21'0" 14.0362°	14°21'0" 14.0362°	18°26'06" 18.4349°	18°26'06" 18.4349°	18°26'06" 18.4349°	18°26'06" 18.4349°	18°26'06" 18.4349°	18°26'06" 18.4349°	18°26'06" 18.4349°	19°58'59" 19.983°	18°26'06" 18.4349°	26°33'54" 26.565°	19°58'59" 19.983°	19°58'59" 19.983°	18°26'06" 18.4349°
α ₄ (°)	-	1:10 5°42'38" 5.7106°	-	-	7°17'47" 7.2965°	7°17'47" 7.2965°	7°17'47" 7.2965°	5°42'38" 5.7106°	7°7'30" 7.125°	6°51'42" 6.8618°	7°6'58" 7.1162°	7°7'30" 7.125°	5°42'38" 5.7106°	5°42'38" 5.711°	5°42'38" 5.711°	5°42'38" 5.711°	7°17'47" 7.2965°



TYPES OF TRANSPORT RAILS

TYPE C

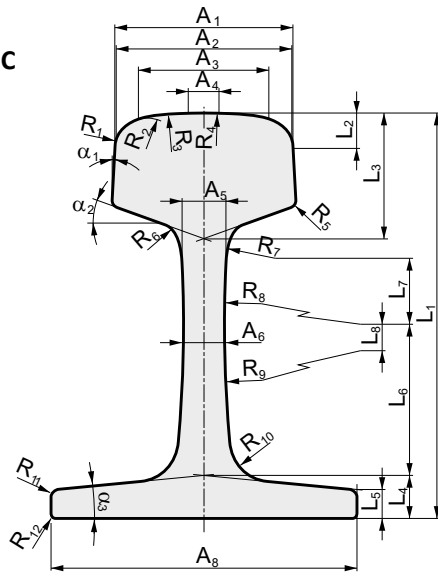

PROFILE	54E4	54E5	55E1	56E1	60E1	60E2	R50	R65	Rail 90ARA-A	Rail 100B	Rail 100RE	Rail 115RE	Rail 119RE	Rail 132RE	Rail 136RE	Rail 141RE
Former designation	-	54E1AHC	U55	BS 113lb BR Variant	UIC 60	-			TR45	100 ARA-B		TR57			TR68	
Rail profile type	A	A	B	B	A	A	C	C	C	C	C	C	C	C	C	C
A ₁ (mm)	67	70.2	62	69.85	72	72	72	73	63	65.0875	65.4456	68.04	66.5	75.17	72.95	74.31
A ₂ (mm)	66	-	40.588	51.235	-	70.774	-	-	-	-	-	61.6	-	-	-	-
A ₃ (mm)	62.98	51.97	27.946	11.787	52.053	48.913	45.7	49.1	45.2	52.8	-	52.6	43.43	65.9	52.75	57.2
A ₄ (mm)	41.342	5.91	19	20	20.456	23.778	20	20	-	31.8	47.6	28	31.2	38.1	35.56	28
A ₅ (mm)	16	16	134	140	16.5	16.5	-	-	-	-	-	-	-	-	-	-
A ₆ (mm)	125	140	-	-	150	150	16	18	14.3	14.3	14.3	15.9	15.9	16.7	17.5	17.5
A ₇ (mm)	-	-	-	-	-	-	-	-	-	-	-	-	-	-	-	-
A ₈ (mm)	-	-	-	-	-	-	132	150	130.2	130.6	136.5	139.7	139.7	152.4	152.4	152.4
L ₁ (mm)	154	159	155	158.75	172	172	152	180	142.9	143.3	152.4	168.3	173	181	185.7	188.9
L ₂ (mm)	14.28	15.4	13.42	14.53	14.3	14.3	15.4	15.67	9.6	7.035	9.71	12.7	14.732	13.06	14.29	15.9
L ₃ (mm)	55	49.4	53	49.21	51	51	42	45	37.3	43.3	42.1	42.9	47.6	44.5	49.2	54.8
L ₄ (mm)	29	30.2	31	30.16	31.5	31.5	27	30	25.4	27.4	27	28.6	28.6	30.2	30.2	30.2
L ₅ (mm)	12	11	14	11.2	11.5	11.5	10.5	11.2	-	-	9.92	11.1	11.1	11.1	11.1	11.2
L ₆ (mm)	46	46	-	-	60.75	60.75	31.5	52.5	48.4	36.3	48.4	53.9	54	68.2	75.82	68.2
L ₇ (mm)	-	-	-	-	19.5	19.5	-	45.1	-	-	-	25	30.39	25.87	21.2	27.33
L ₈ (mm)	-	-	-	-	51.5	51.6	0	0	0	0	0	0	0	0	0	0
L ₉ (mm)	-	-	-	-	32	32	-	-	-	-	-	-	-	-	-	-
R ₁ (mm)	7.64	13	13	12.7	13	8	15	15	9.5	9.5	9.5	9.5	14.3	9.5	14.3	14.3
R ₂ (mm)	15.5	-	60	80	-	16	-	-	-	-	-	14.3	-	-	-	-
R ₃ (mm)	16.5	80	200	305	80	70	80	80	-	38.1	-	44.5	38.1	31.8	31.75	44.5
R ₄ (mm)	115	300	2	3	300	200	500	500	355.6	203.2	355.6	203.2	355.6	254	355.6	203.2
R ₅ (mm)	5	3	12	8	3	3	3	3	1.6	1.6	1.6	1.6	6.4	1.6	7.94	7.94
R ₆ (mm)	16	8	-	-	7	7	10	7	9.5	7.9	9.5	19.05	19.1	8	7.94	7.94
R ₇ (mm)	-	22	-	-	35	35	-	15	-	-	-	76.2	76.2	19.05	19.05	19.05
R ₈ (mm)	500	508	12	15	120	120	325	370	355.6	304.8	355.6	355.6	355.6	203.2	203.2	203.2
R ₉ (mm)	-	-	23	20	120	120	350	400	355.6	304.8	355.6	355.6	355.6	406.4	508	508
R ₁₀ (mm)	-	-	3	3	35	35	20	25	9.5	7.9	15.9	19.05	19.05	22.2	19.05	19.05
R ₁₁ (mm)	2	2	2	1.5	7	7	4	4	1.6	1.6	1.6	1.6	1.6	3.2	3.2	3.2
R ₁₂ (mm)	-	-	-	-	40	40	2	2	1.6	1.6	1.6	1.6	1.6	1.6	1.6	1.6
R ₁₃ (mm)	3	3	-	-	4	4	-	-	-	-	-	-	-	-	-	-
R ₁₄ (mm)	2	2	-	-	2	2	-	-	-	-	-	-	-	-	-	-
alpha ₁ (°)	1:17.2 3°19'39" 3.3274°	1:20 2°51'45" 2.8624°	1:20 2°51'45" 2.8624°	1:20 2°51'45" 2.8624°	1:20 2°51'45" 2.8624°	1:20 2°51'45" 2.8624°	1:20 2°51'45" 2.8624°	1:20 2°51'45" 2.8624°	1:16 3°34'35" 3.5763°	1:19 3°0'46" 3.013°	1:16 3°34'35" 3.5763°	1:40 1°25'56" 1.4321°	1:40 1°25'56" 1.4321°	1:40 1°25'56" 1.4321°	1:40 1°25'56" 1.4321°	1:11.43 5° 5°
alpha ₂ (°)	13 18°26'06" 18.4349°	12.75 19°58'59" 19.983°	13 18°26'06" 18.4349°	12.75 19°58'59" 19.983°	12.75 19°58'59" 19.983°	12.75 19°58'59" 19.983°	14 14°2'10" 14.0362°	14 14°2'10" 14.0362°	14 14°2'10" 14.0362°	14.33 13° 13°	14 14°2'10" 14.0362°	14 14°2'10" 14.0362°	14 14°2'10" 14.0362°	14 14°2'10" 14.0362°	14 14°2'10" 14.0362°	13 18°26'6" 18.4349°
alpha ₃ (°)	13 18°26'06" 18.4349°	12.75 19°58'59" 19.983°	13 18°26'06" 18.4349°	12.75 19°58'59" 19.983°	12.75 19°58'59" 19.983°	12.75 19°58'59" 19.983°	14 14°2'10" 14.0362°	14 14°2'10" 14.0362°	14 14°2'10" 14.0362°	14.33 13° 13°	14 14°2'10" 14.0362°	14 14°2'10" 14.0362°	14 14°2'10" 14.0362°	14 14°2'10" 14.0362°	14 14°2'10" 14.0362°	14 14°2'10" 14.0362°
alpha ₄ (°)	1:7.81 7°17'47" 7.2965°	1:10 5°42'38" 5.711°	1:10 5°42'38" 5.7106°	1:10 5°42'38" 5.7106°	1:14 4°58" 4.0856°	1:14 4°58" 4.0856°	-	-	-	-	-	-	-	-	-	-



RAIL STEEL GRADES

Rail steel grades		Chemical composition (% by mass)											Mechanical properties		
		C	Si	Mn	P	S	Cr	Al	V	Rm (MPa)	Elongation (%)	BHN Hardness Centre line			
Specification Grade															
High speed and mixed traffic															
UIC 860-0	700	0.40/0.60	0.05/0.35	0.80/1.25	≤ 0.050	≤ 0.050							680/830	≥ 14	
	900A	0.60/0.80	0.10/0.50	0.80/1.30	≤ 0.040	≤ 0.040							880/1030	≥ 10	
	900B	0.55/0.75	0.10/0.50	1.30/1.70	≤ 0.040	≤ 0.040							880/1030	≥ 10	
EN 13674-1	R200	0.40/0.60	0.15/0.58	0.70/1.20	≤ 0.035	0.008/0.035	≤ 0.15	≤ 0.004	≤ 0.03	≤ 0.004	≤ 0.03	≤ 0.03	≥ 680	≥ 14	200/240
	R220	0.50/0.60	0.20/0.60	1.00/1.25	≤ 0.025	0.008/0.025	≤ 0.15	≤ 0.004	≤ 0.03	≤ 0.004	≤ 0.03	≤ 0.03	≥ 770	≥ 12	220/260
	R260	0.62/0.80	0.15/0.58	0.70/1.20	≤ 0.025	0.008/0.025	≤ 0.15	≤ 0.004	≤ 0.03	≤ 0.004	≤ 0.03	≤ 0.03	≥ 880	≥ 10	260/300
	R260Mn	0.55/0.75	0.15/0.60	1.30/1.70	≤ 0.025	0.008/0.025	≤ 0.15	≤ 0.004	≤ 0.03	≤ 0.004	≤ 0.03	≤ 0.03	≥ 880	≥ 10	260/300
	R350HT	0.72/0.80	0.15/0.58	0.70/1.20	≤ 0.020	≤ 0.025	≤ 0.15	≤ 0.004	≤ 0.03	≤ 0.004	≤ 0.03	≤ 0.03	≥ 1175	≥ 9	350/390
	R350LHT	0.72/0.80	0.15/0.58	0.70/1.20	≤ 0.020	≤ 0.025	≤ 0.30	≤ 0.004	≤ 0.03	≤ 0.004	≤ 0.03	≤ 0.03	≥ 1175	≥ 9	350/390
	R370CrHT	0.70/0.82	0.40/1.00	0.70/1.10	≤ 0.020	≤ 0.020	0.40/0.60	≤ 0.004	≤ 0.03	≤ 0.004	≤ 0.03	≤ 0.03	≥ 1280	≥ 9	370/410
EN 13674-2	R260Cr	0.40/0.60	0.20/0.45	1.20/1.60	≤ 0.025	≤ 0.025	0.40/0.60	≤ 0.004	≤ 0.06	≤ 0.004	≤ 0.06	≤ 0.06	≥ 880	≥ 10	260/300
IRS	880	0.60/0.80	0.10/0.50	0.80/1.30	≤ 0.030	≤ 0.030	-	≤ 0.015	-	-	-	-	≥ 880	≥ 10	≥ 260
	1080HH	0.60/0.80	0.10/0.50	0.80/1.30	≤ 0.030	≤ 0.030	-	≤ 0.015	-	-	-	-	≥ 1080	≥ 10	340/390

Heavy haul															
Arema	Standard	0.74/0.86	0.10/0.60	0.75/1.25	≤ 0.020	≤ 0.020	≤ 0.3	≤ 0.01	≤ 0.01	≤ 0.01	≤ 0.01	≤ 0.01	≥ 985	≥ 10	≥ 310
	Low alloy standard	0.72/0.82	0.10/0.50	0.80/1.10	≤ 0.020	≤ 0.020	0.25/0.40	≤ 0.005	≤ 0.01	≤ 0.01	≤ 0.01	≤ 0.01	≥ 985	≥ 10	≥ 310
	Low alloy intermediate	0.72/0.82	0.10/1.00	0.70/1.25	≤ 0.020	≤ 0.020	0.40/0.70	≤ 0.005	≤ 0.01	≤ 0.01	≤ 0.01	≤ 0.01	≥ 1015	≥ 8	≥ 325
	Standard high strength	0.74/0.86	0.10/0.60	0.75/1.25	≤ 0.020	≤ 0.020	≤ 0.3	≤ 0.01	≤ 0.01	≤ 0.01	≤ 0.01	≤ 0.01	≥ 1180	≥ 10	≥ 370
	Low alloy high strength	0.72/0.82	0.10/1.00	0.70/1.25	≤ 0.020	≤ 0.020	0.40/0.70	≤ 0.005	≤ 0.01	≤ 0.01	≤ 0.01	≤ 0.01	≥ 1180	≥ 10	≥ 370
EN 13674-1	R350HT	0.72/0.80	0.15/0.58	0.70/1.20	≤ 0.020	≤ 0.020	≤ 0.15	≤ 0.004	≤ 0.03	≤ 0.004	≤ 0.03	≤ 0.03	≥ 1175	≥ 9	350/390
	R350LHT	0.72/0.80	0.15/0.58	0.70/1.20	≤ 0.020	≤ 0.020	≤ 0.30	≤ 0.004	≤ 0.03	≤ 0.004	≤ 0.03	≤ 0.03	≥ 1175	≥ 9	350/390
	R370CrHT	0.70/0.82	0.40/1.00	0.70/1.10	≤ 0.020	≤ 0.020	0.40/0.60	≤ 0.004	≤ 0.03	≤ 0.004	≤ 0.03	≤ 0.03	≥ 1280	≥ 9	370/410

Urban transport															
EN 14811	R200	0.40/0.60	0.15/0.58	0.70/1.20	≤ 0.035	≤ 0.035	≤ 0.15	≤ 0.004	≤ 0.04	≤ 0.004	≤ 0.04	≤ 0.04	≥ 680	≥ 14	200/240
	R220G1	0.50/0.65	0.15/0.58	1.00/1.25	≤ 0.025	≤ 0.025	≤ 0.15	≤ 0.004	≤ 0.04	≤ 0.004	≤ 0.04	≤ 0.04	≥ 780	≥ 12	220/260
	R260	0.62/0.80	0.15/0.58	0.70/1.20	≤ 0.025	≤ 0.025	≤ 0.15	≤ 0.004	≤ 0.04	≤ 0.004	≤ 0.04	≤ 0.04	≥ 880	≥ 10	260/300
Customer	R200V	0.40/0.48	0.15/0.58	0.70/1.10	≤ 0.035	≤ 0.035			0.08/0.20				≥ 680	≥ 15	200/260
B57865	Conductor Rail	≤ 0.08	≤ 0.05	≤ 0.30	≤ 0.05	≤ 0.05								Resistance < 11.04 μΩ.cm	
Customer	Conductor Rail	0.04/0.06		0.25/0.45	≤ 0.025	≤ 0.020							≥ 300	Resistance < 14 μΩ.cm	
	700V	0.20/0.30	0.20/0.30	1.20/1.50	≤ 0.025	≤ 0.025	≤ 0.10	≤ 0.004	0.10/0.16	≤ 0.004	0.10/0.16	≤ 0.004	≥ 685	≥ 14	200/240
	900V	0.41/0.51	0.20/0.30	1.10/1.40	≤ 0.025	≤ 0.025	≤ 0.15	≤ 0.004	0.10/0.15	≤ 0.004	0.10/0.15	≤ 0.004	≥ 885	≥ 10	260/300



CALCULATION OF ANGLE 1:X

Incline or gradient is often used to indicate the steepness of a slope which is the magnitude of its incline or slope as compared to the horizontal.

The incline or gradient, is generally described by the 'rise' (**1**) compared with the 'run' (**X**).

Example: 1:20 means that for every 20 millimeters, the height will increase by 1 millimeter.

To calculate the angle of the incline, you can use the mathematical equation:

$$\tan^{-1}\alpha = 1/X$$

Inclination 1:X	α (°)	α (°,'")	$90^\circ-\alpha$ (°)	$90^\circ-\alpha$ (°,'")
1:1.75	29.744	29°44'42"	60.255	60°15'18"
1:2	26.565	26°33'54"	63.435	63°26'6"
1:2.25	23.962	23°57'45"	66.038	66°2'15"
1:2.75	19.983	19°58'59"	70.017	70°1'11"
1:3	18.435	18°26'6"	71.565	71°33'54"
1:4	14.036	14°2'10"	75.964	75°57'50"
1:4.85	11.650	11°39'11"	78.350	78°20'59"
1:5	11.310	11°18'36"	78.690	78°41'24"
1:6	9.462	9°27'44"	80.538	80°32'16"
1:7	8.130	8°7'48"	81.870	81°52'12"
1:8	7.125	7°7'30"	82.875	82°52'30"
1:9	6.340	6°20'25"	83.660	83°39'35"
1:10	5.711	5°42'38"	84.289	84°17'22"
1:11	5.194	5°11'40"	84.806	84°48'20"
1:12	4.764	4°45'49"	85.236	85°14'11"
1:13	4.399	4°23'55"	85.601	85°36'5"
1:14	4.086	4°5'8"	85.914	85°54'52"
1:15	3.814	3°48'51"	86.186	86°11'9"
1:16	3.576	3°34'35"	86.424	86°25'25"
1:17	3.366	3°21'59"	86.634	86°38'11"
1:18	3.180	3°10'47"	86.820	86°49'13"
1:19	3.013	3°0'46"	86.987	86°59'14"
1:20	2.862	2°51'45"	87.138	87°8'15"
1:21	2.726	2°43'35"	87.274	87°16'25"
1:22	2.603	2°36'9"	87.397	87°23'51"
1:23	2.490	2°29'22"	87.510	87°30'38"
1:24	2.386	2°23'9"	87.614	87°36'51"
1:25	2.291	2°17'26"	87.709	87°42'34"
1:40	1.432	1°25'56"	88.568	88°34'5"

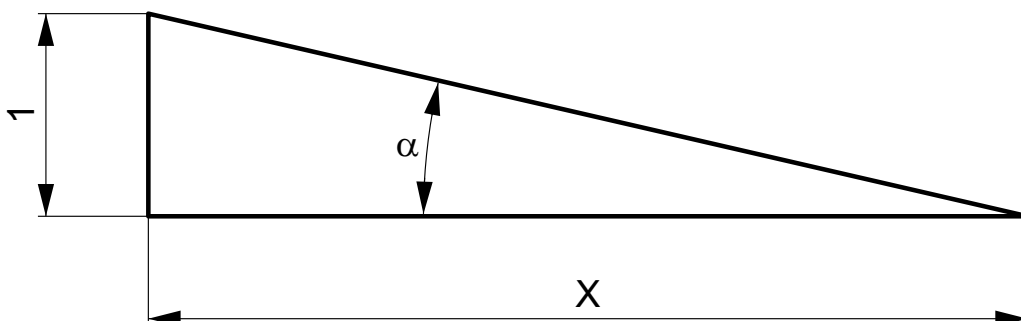



FORMULA FOR CALCULATING CUTTING DATA - TURNING

Value	Formula	Unit	Note
Number of revolutions	$n = \frac{v_c \cdot 1000}{D \cdot p}$	(1/min)	<p>n Number of revolutions (1/min)</p> <p>D Diameter (of tool or workpiece) (mm)</p> <p>v_c Cutting speed (m/min)</p> <p>f_{rev} Feed per revolution (mm/rev)</p> <p>f_{min} Feed per minute (Linear Feedrate) (mm/min)</p>
Cutting speed	$v_c = \frac{p \cdot D \cdot n}{1000}$	(m/min)	
Feed per revolution	$f_{rev} = \frac{f_{min}}{n}$	(mm/rev)	
Feed per minute (Linear Feedrate)	$f_{min} = v_f = f_{rev} \cdot n$	(mm/min)	
Max. height of profile R_{max}	$R_{max} = \frac{125 \cdot f_{rev}^2}{RE}$	(μm)	
Surface finish R_a	$R_a = \frac{43,9 \cdot f_{rev}^{1,88}}{RE^{0,97}}$	(μm)	<p>R_{max} max. height of profile (mm)</p> <p>R_a surface finish (mm)</p> <p>f_{rev} feed per revolution (mm/rev)</p> <p>RE nose radius (mm)</p>
Chip cross section	$A = f_{rev} \cdot a_p$	(mm ²)	<p>A Chip cross section (mm²)</p> <p>f_{rev} Feed per revolution (mm/rev)</p> <p>a_p Axial depth of cut (mm)</p> <p>κ_r Primary edge setting angle (°)</p> <p>h Chip thickness (mm)</p> <p>v_c Cutting speed (m/min)</p> <p>f_{min} Feed per minute (Linear Feedrate) (mm/min)</p> <p>Q Material removal rate per minute (cm³/min)</p> <p>INSD Insert diameter (mm)</p>
Chip thickness (For insert with straight edge)	$h = f_{rev} \cdot \sin \kappa_r$	(mm)	
Chip thickness (For round cutting insert)	$h = f_{rev} \cdot \sqrt{\frac{a_p}{INSD}}$	(mm)	
Metal removal rate	$Q = a_p \cdot f_{rev} \cdot v_c$	(cm ³ /min)	
Power demand	$P_c = \frac{a_p \cdot f_{rev}^{1-c} \cdot k_{c1} \cdot v_c \cdot k_{\kappa_r}}{6 \cdot 10^4 \cdot \eta}$	(kW)	<p>P_c Power demand (kW)</p> <p>a_p Depth of cut (mm)</p> <p>f_{rev} Feed (mm/rev)</p> <p>c Constant KTV (1)</p> <p>k_c Specific cutting force (MPa)</p> <p>k_{κ_r} κ_r angle constant (1)</p> <p>η Efficiency (usually η = 0,75) (1)</p> <p>x Machined material constant (1)</p>
Approximate power demand	$P_c = \frac{a_p \cdot f_{rev} \cdot v_c}{x}$	(kW)	

Material	Steel	Cast iron	Al
Coefficient x	20	25	100



FORMULA FOR CALCULATING CUTTING DATA - MILLING

Value	Unit	Formula
Number of revolutions	(rev/min)	$n = \frac{v_c \times 1000}{DC \times p}$
Cutting speed	(m/min)	$v_c = \frac{p \times DC \times n}{1000}$
Feed per revolution	(mm/rev)	$f_{rev} = \frac{f_{min}}{n} = f_z \times z$
Feed per minute (speed of feed)	(mm/min)	$f_{min} = v_f = f_{rev} \times n = f_z \times z \times n$
Feed per tooth	(mm/tooth)	$f_z = \frac{f_{rev}}{z} = \frac{f_{min}}{n \times z}$
Chip cross section	(mm ²)	$A = f_z \times a_p$
Chip thickness (for inserts with a straight edge)	(mm)	$h = f_z \times \sin KAPR$
Chip thickness (for round cutting inserts)	(mm)	$h = f_z \times \sqrt{\frac{a_p}{INSD}}$
Metal removal rate	(cm ³ /min)	$Q = \frac{a_p \times a_e \times f_{min}}{1000}$
Power demand	(kW)	$P_c = \frac{a_p \times a_e \times f_{min}}{60 \times 10^6 \times h} \times k_c \times k_g$
Approximate power demand	(kW)	$P_c = \frac{a_p \times a_e \times f_{min}}{x}$

Note:

	Quantity	Unit
n	Number of revolutions	(rev/min)
DC	Diameter (of tool or work piece)	(mm)
v_c	Cutting speed	(m/min)
f_{rev}	Feed per revolution	(mm/rev)
A	Chip cross section	(mm ²)
a_p	Axial depth of cut (depth of cut)	(mm)
a_e	Radial depth of cut (width of cut)	(mm)
KAPR	Setting angle	(°)
f_{min}	Feed per minute (sometimes called speed of feed)	(mm/min)
f_z	Feed per tooth	(mm/tooth)
z	Number of teeth	(-)
INSD	Diameter of insert	(mm)

	Quantity	Unit
h	Chip thickness	(mm)
Q	Material removal rate per minute	(cm ³ /min)
P_c	Power demand	(kW)
k_c	Cutting force per mm ²	(MPa)
k_γ	Coefficient of influence of angle γ ₀	(°)
η	Machine efficiency usually η = 0.75	(-)
x	Coefficient of influence of work piece material	(-)

Material	Steel	Cast iron	Al
Coefficient x	24 000	30 000	120 000



HARDNESS TABLE

Hardness and Tensile Strength

HV	HRC	HB	Tensile Strength	
			(N/mm ²)	(Tons/ sq. in.)
940	68	—	—	—
900	67	—	—	—
864	66	—	—	—
829	65	—	—	—
800	64	—	—	—
773	63	—	—	—
745	62	—	—	—
720	61	—	—	—
698	60	—	—	—
675	59	—	—	—
655	58	—	2200	142
650	—	618	2180	141
640	—	608	2145	139
639	57	607	2140	138
630	—	599	2105	136
620	—	589	2070	134
615	56	584	2050	133
610	—	580	2030	131
600	—	570	1995	129
596	55	567	1980	128
590	—	561	1955	126
580	—	551	1920	124
578	54	549	1910	124
570	—	542	1880	122
560	53	532	1845	119
550	—	523	1810	117
544	52	517	1790	116
540	—	513	1775	115
530	—	504	1740	113
527	51	501	1730	112
520	—	494	1700	110
514	50	488	1680	109
510	—	485	1665	108
500	—	475	1630	105
497	49	472	1620	105
490	—	466	1595	103
484	48	460	1570	102
480	—	456	1555	101
473	47	449	1530	99
470	—	447	1520	98
460	—	437	1485	96
458	46	435	1480	96
450	—	428	1455	94
446	45	424	1440	93
440	—	418	1420	92

HV	HRC	HB	Tensile Strength	
			(N/mm ²)	(Tons/ sq. in.)
434	44	413	1400	91
423	43	402	1360	88
413	42	393	1330	86
403	41	383	1300	84
392	40	372	1260	82
382	39	363	1230	80
373	38	354	1200	78
364	37	346	1170	76
355	36	337	1140	74
350	—	333	1125	73
345	35	328	1110	72
340	—	323	1095	71
336	34	319	1080	70
330	—	314	1060	69
327	33	311	1050	68
320	—	304	1030	67
317	32	301	1020	66
310	31	295	995	64
302	30	287	970	63
300	—	285	965	62
295	—	280	950	61
293	29	278	940	61
290	—	276	930	60
287	28	273	920	60
285	—	271	915	59
280	27	266	900	58
275	—	261	880	57
272	26	258	870	56
270	—	257	865	56
268	25	255	860	56
265	—	252	850	55
260	24	247	835	54
255	23	242	820	53
250	22	238	800	52
245	—	233	785	51
243	21	231	780	50
240	—	228	770	50
235	—	223	755	49
230	—	219	740	48
225	—	214	720	47
220	—	209	705	46
215	—	204	690	45
210	—	199	675	44
205	—	195	660	43
200	—	190	640	41

SIMPLY RELIABLE

As a professional you can judge the quality of work by just looking at the chip. Our chip is a clean and uncomplicated shape that in itself tells a story. It is a clear and consistent signal and that's why we use it as a symbol for being **Simply Reliable**.

DORMER PRAMET

www.dormerpramet.com



**CONTACTS TO LOCAL
SALES SUPPORT
ALWAYS UP TO DATE!**



DP-CAT-RAIL-SHORT-2022-EN

FOLLOW US...



ONLINE



SEGMENTS



LIBRARY APP.



CALCULATOR APP.

