

DORMER PRAMET

NEW PRODUCTS

2023.1



 PRAMET



T9415

NEW GENERATION MT-CVD GRADE

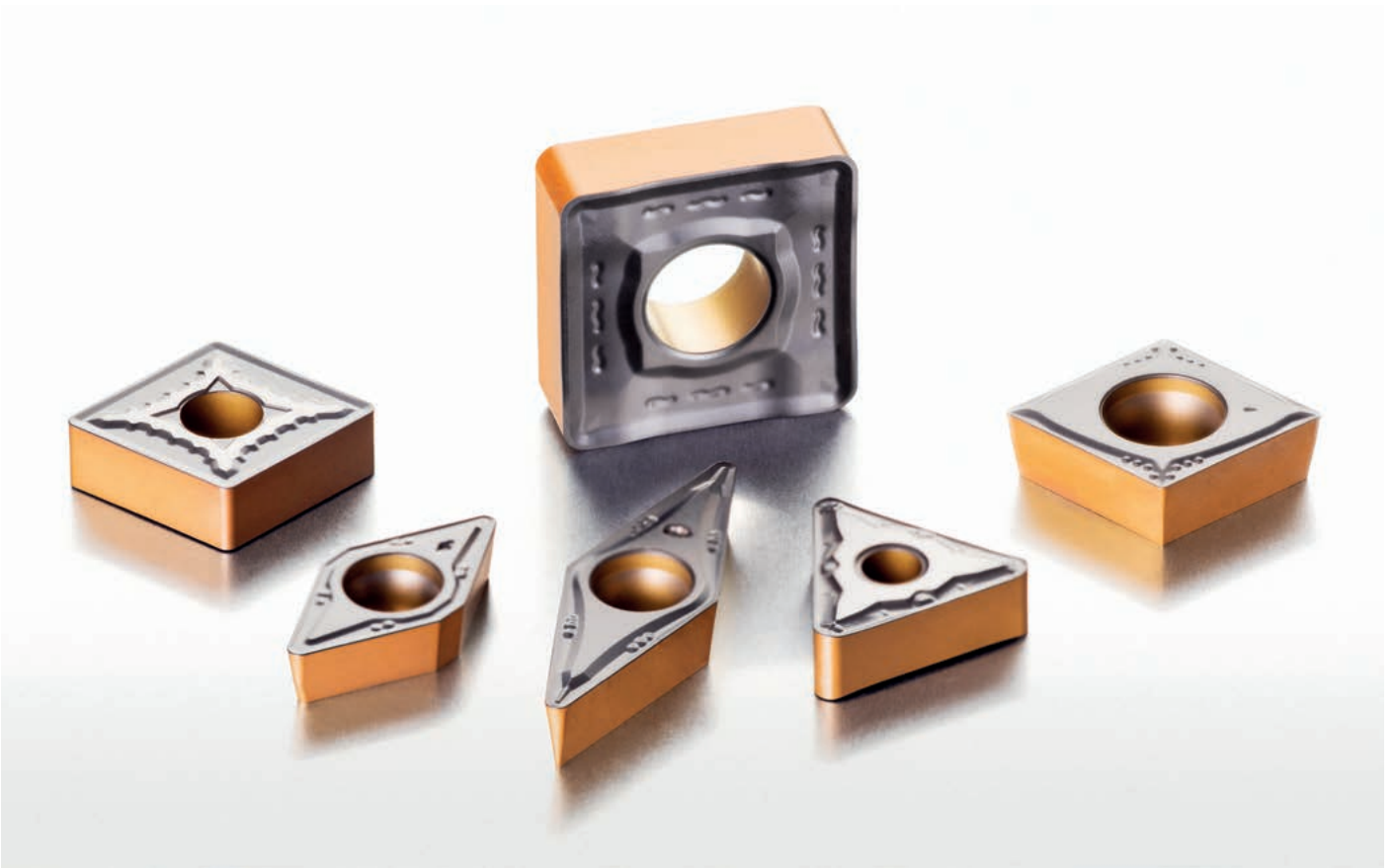

SON06C

**ECONOMICAL 16-EDGE
FACE MILLING**

SLN12X

**PRODUCTIVE TANGENTIAL
SHOULDER MILLING**





DORMER PRAMET



ON TOP OF EFFICIENCY

T9415 | Our most advanced steel turning grade
verified by customers.



www.dormerpramet.com/T9415

PRAMET



4	TURNING	T9415	NEW GENERATION MT-CVD GRADE
38		T8430	ADDITIONAL CHIPBREAKERS AND RADII
40		KR	CAST IRON TURNING EXPANSION
42		S-TYPE	SLIDING HEAD TURNING TOOLS
44		P & M	NEW LINE OF TOOLS FOR NEGATIVE INSERTS
46	MILLING	SON06C	ECONOMICAL 16-EDGED FACE MILLING
56		SSD13F	VERSATILE FACE MILLING
64		SLN12X	PRODUCTIVE TANGENTIAL SHOULDER MILLING
72		SNGX 11	STRONG HIGH FEED GEOMETRY – HM
74		SBN10	ADDITIONAL SHELL MILL CUTTERS
76		SWN04C	HIGH PRECISION CUTTERS REVAMPED
79			TECHNICAL PART



T9415

NEW GENERATION MT-CVD GRADE

INTRODUCTION



A new generation turning grade has been introduced offering one of the highest levels of productivity and versatility in the market today. The T9415 is our most advanced MT-CVD grade, bringing greater stability and performance in various cutting conditions. It covers a broad application range, replacing our previous T9310 and T9315 grades. In addition, it also partly overlaps with grade T9325, making T9415 the first choice for steel turning.

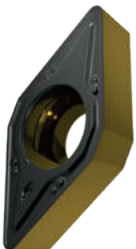

T9415

- Positive inserts
- Steels, cast irons, hard steels

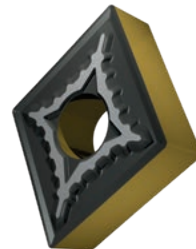

T9415

- Negative inserts
- Steels, cast irons, hard steels



TURNING INSERTS

FEATURES & BENEFITS

Greatly improved application range.



FIRST CHOICE GRADE

for various steel (ISO-P) turning.

New MT-CVD coating is 30 % thicker resulting in greater resistance to flank wear, crater wear and plastic deformation.



TOOL LIFE AND PRODUCTIVITY

significantly increased compared to previous grades.

Newly developed post-treatment process reinforces stability of cutting edge.



IMPROVED RELIABILITY,

especially in unstable conditions.

Inserts produced on state-of-the-art electronic presses.



HIGH PRECISION

improves indexing accuracy and reduces idle time.

Optimized cutting-edge geometry.



REDUCED CUTTING FORCES

and enhanced performance.

Insert seating face ground after coating provides larger contact area and enhances heat transfer away from the cutting zone.



BETTER SEATING STABILITY

and improved overall tool life.

Manufactured using the latest technologies.



SUSTAINABLE

and environmentally friendly offer.

TiN coated gold colored insert flanks.



EASIER WEAR DETECTION.

APPLICATION AREA OF MT-CVD TURNING GRADES

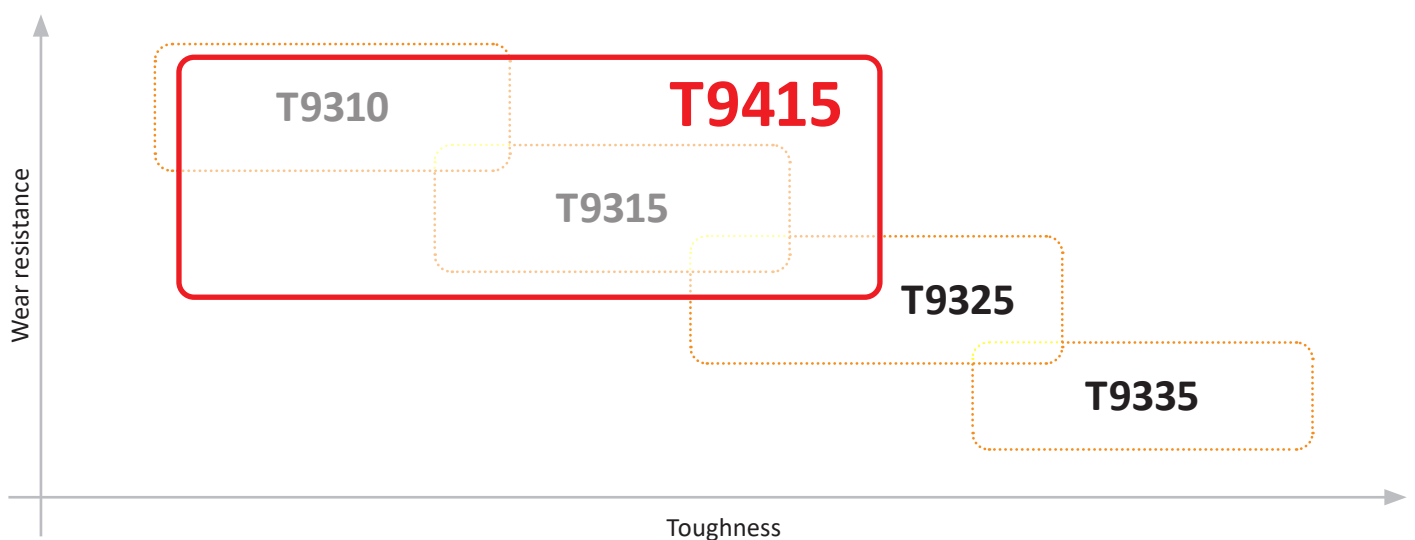



T9415

NEW GENERATION MT-CVD GRADE

GRADE COMPOSITION

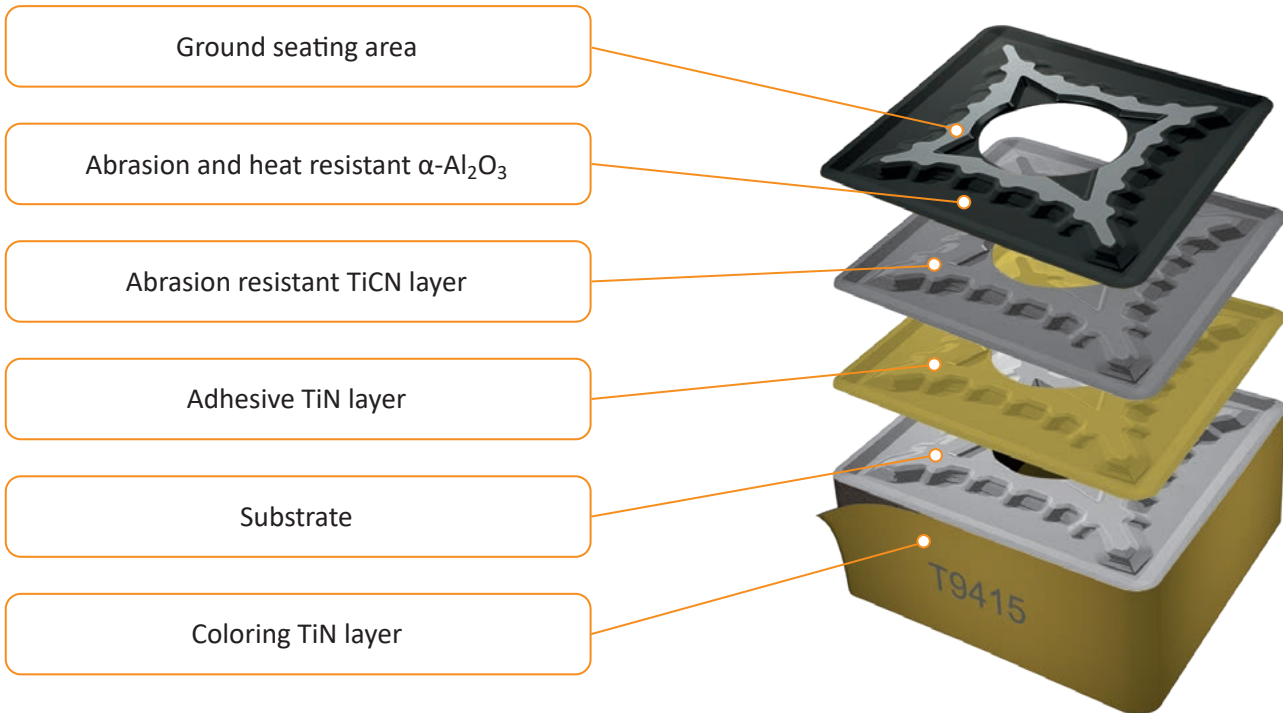

New CVD coating is 30 % thicker compared to previous grade.

FEATURES SPIDER DIAGRAM

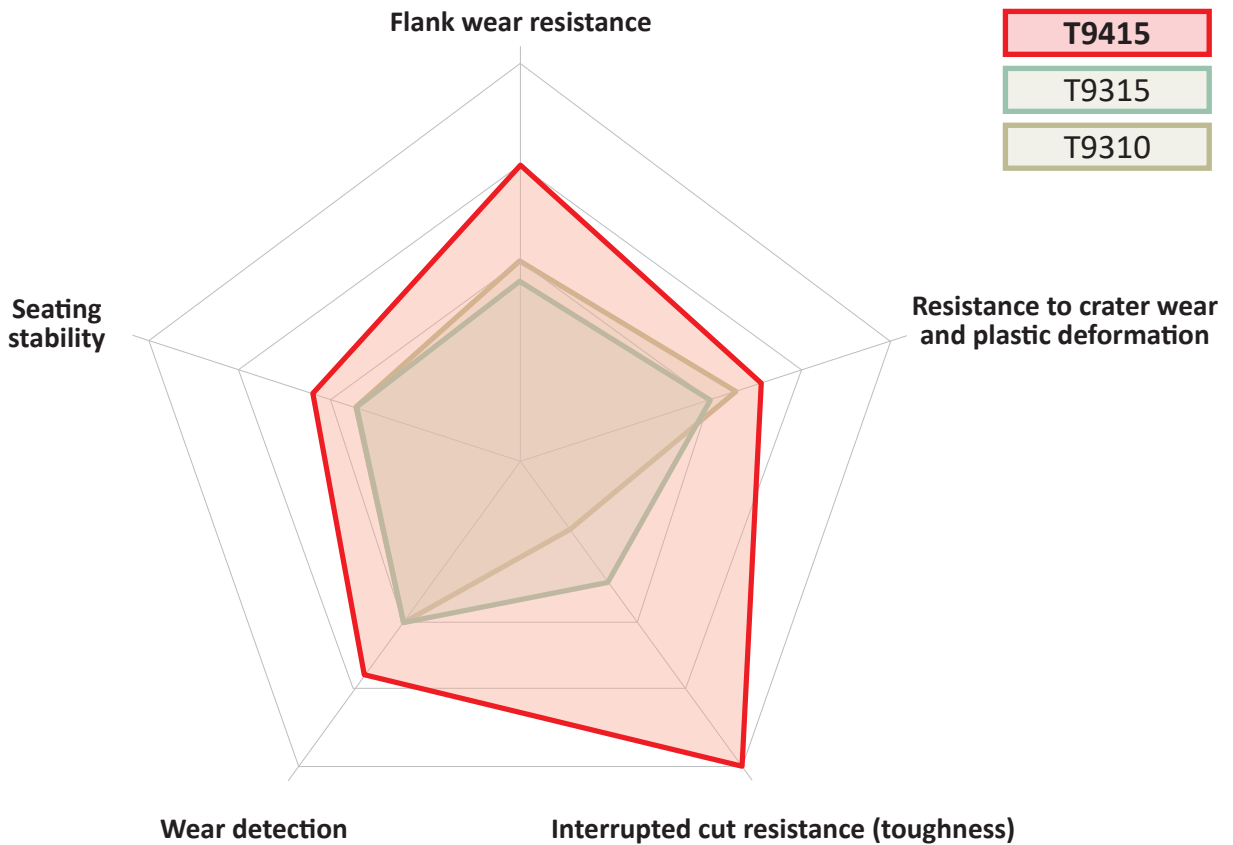

MACHINING EXAMPLES

Photos from continuous cutting. All taken after 16 minutes.

Material: C45 (Medium carbon steel)
 Machining: Continuous cut
 Application: Longitudinal turning
 Coolant: Yes

Cutting conditions		
v_c (m/min)	f_n (mm/r)	a_p (mm)
300	0.25	2
Insert		
CNMG 120408E-M		

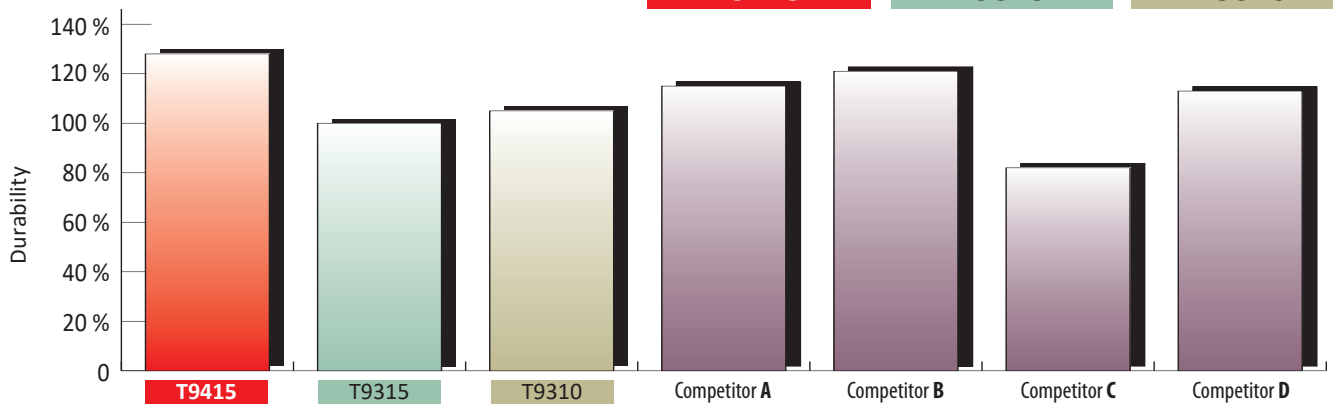

Material: 37Cr4 (Chromium steel)
 Machining: Interrupted cut
 Application: Longitudinal turning
 Coolant: No

Cutting conditions		
v_c (m/min)	f_n (mm/r)	a_p (mm)
120	0.2	1
Insert		
CNMG 120408E-M		

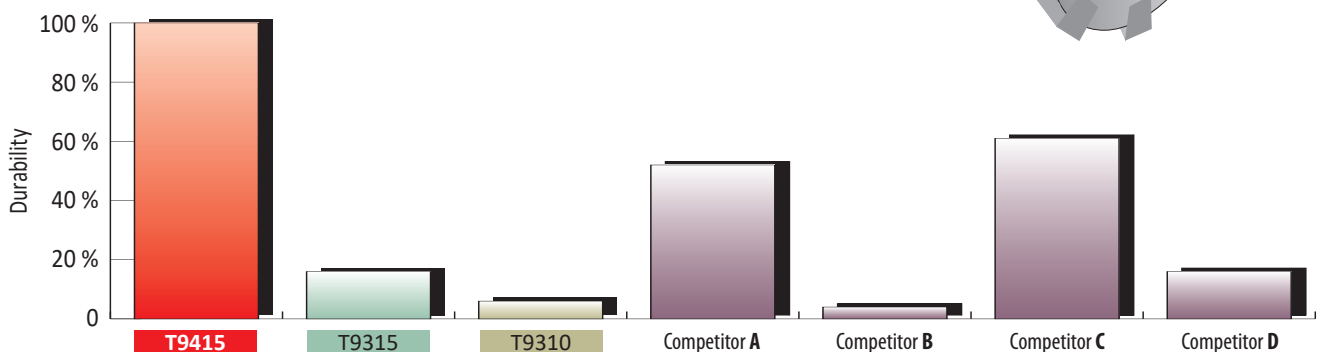
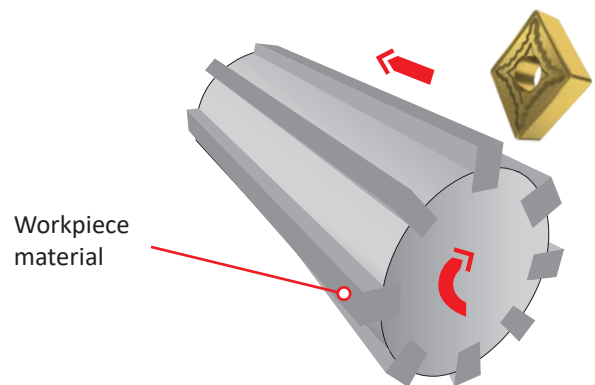

v_c = cutting speed, f_n = feed per revolution, a_p = depth of cut



T9415

NEW GENERATION MT-CVD GRADE

SUCCESS STORIES – T9415

Company: Subcontractor for a leading Brazilian oil and gas company.

Component: Separator ring

Material: SAE 1045 (Carbon Steel)

Hardness: 250 HB

Application: Internal continuous turning. Workpiece is clamped directly into lathe through hydraulic clamping system.

Previous results: With previous competitor insert, five pieces were completed.

Result with T9415: A total of 10 pieces completed, doubling production.

Dormer Pramet solution

CNMG 120412E-RM:T9415

Machining data

v_c (m/min)	f_n (mm/r)	a_p (mm)
250	0.3	3

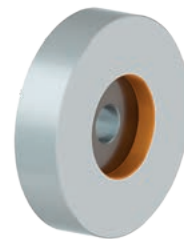

Company: Italian manufacturer of shaft locking devices for the power generation and process industries.

Material: C45N (Medium carbon steel)

Hardness: 172 – 242 HB

Coolant: Yes

Application: External continuous turning, short cuts

Previous result: External turning of part diameter was carried out by a competitor solution. The customer wanted better tool life, while still achieving high quality surface finish.

Result with T9415: Using the new grade resulted in a 20 % increase in tool life, bringing considerable savings to the customer.

Dormer Pramet solution

CNMG 120412E-RM:T9415

Machining data

v_c (m/min)	f_n (mm/r)	a_p (mm)
200	0.35	3



Company: Industrial valves producer in Italy

Component: Die

Material: DIN 1.2344 (Tool steel)

Hardness: Variable due to faulty heat treatment

Coolant: Yes

Application: Vertical lathe face turning operation with variable hardness of workpiece material.

Previous results: Durability of initial T9325 grade did not resist to the mix of hard and soft cutting conditions. This led to rapid extensive wear of insert and poor surface finish of workpiece.

Result with T9415: The grade worked very well in low cutting speed and feed. It provided the best performance in roughing operations. With one cutting edge, a large component with a 2500 mm diameter was machined.

Dormer Pramet solution

SNMM 250924E-HR:T9415

Machining data

v_c (m/min)	f_n (mm/r)	a_p (mm)
40	0.5	8

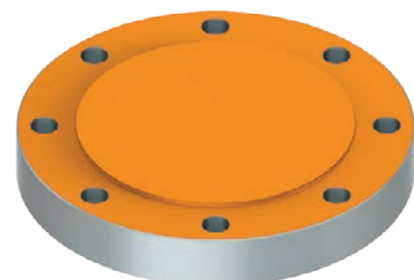



TURNING INSERTS

Company: Czech manufacturer of quality precision parts for energy, building and automotive industries.

Component: Double end-stud

Material: 15142 (42CrMo4 alloy structural steel)

Coolant: Yes

Application: External continuous turning of slim workpiece

Previous result: The customer used a previous generation turning grade which completed three pieces per cutting edge.

Dormer Pramet solution		
TNMG 160408E-SM:T9415		
Machining data		
v_c (m/min)	f_n (mm/r)	a_p (mm)
250	0.4	3



Result with T9415: Applying the new grade, the customer was able to machine at a higher speed and completed six pieces with one cutting edge. This not only significantly increased productivity, but also doubled the life of the cutting tool.

Company: Chinese automotive engineering company

Component: Diesel engine balance block

Material: Q235 (plain carbon structural steel)

Hardness: 180 – 230 HB

Coolant: No

Application: Heavily interrupted cut

Previous result: The customer used a competitor's grade that produced four pieces per cutting edge. The burrs on the workpiece were limiting the insert lifetime.

Dormer Pramet solution		
CNMG 190616E-RM:T9415		
Machining data		
v_c (m/min)	f_n (mm/r)	a_p (mm)
150	0.35	0.6

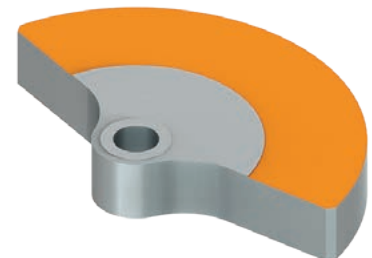

Result with T9415: New grade withstood existing cutting conditions, outperforming the previous option. It helped create six pieces with one cutting edge.











T9415

NEW GENERATION MT-CVD GRADE

WHAT GRADE TO CHOOSE?

					
	T9415	T9310	T9315	T9325	T9335
High cutting speed, high system rigidity (stable working conditions)				-	-
High cutting speed, system rigidity slightly limited (depth of cut changing)		-			-
Medium cutting speed, system rigidity limited (slightly interrupted cut)		-	-		
Low cutting speed, low system rigidity (interrupted cut)	-	-	-	-	

TECHNICAL INFORMATION

Grade identification	Area of application	Application	Feed	Cutting speed	Resistance to adverse working conditions	Coating	Colour	Substrate	Coolant benefit
T9415	P05 – P30					MT-CVD		FGM	++
	K05 – K25								
	H10 – H20								

Grade description:

Highly wear-resistant material designed primarily for finish turning of common carbon and alloy steels. Despite its high abrasion resistance, it is also suitable for interrupted cutting operations. We recommend this material as the first choice for most turning operations, especially in high production applications.



TURNING INSERTS



ISO INSERTS POSITIVE – CHIPBREAKER NAVIGATOR

 Very unstable working conditions

 Unstable working conditions

 Stable working conditions

 Thin-walled and slim workpieces

 1st choice for stable working conditions
 Variants for different working conditions

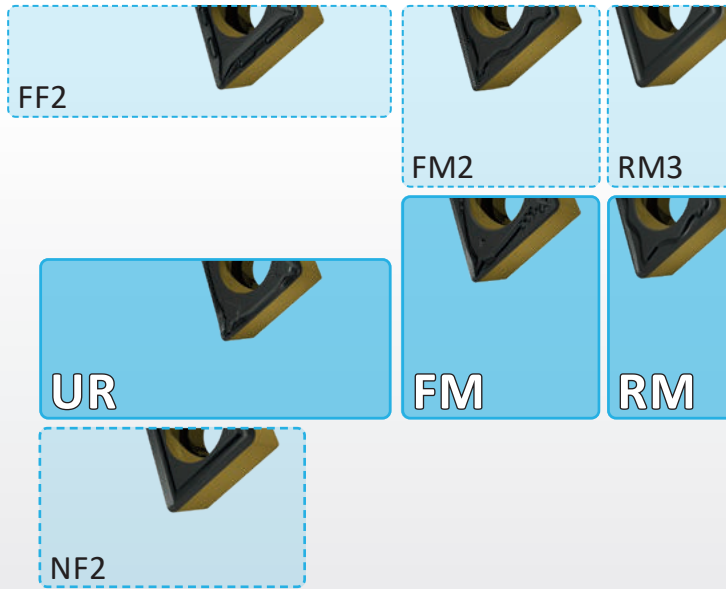



ISO INSERTS NEGATIVE – CHIPBREAKER NAVIGATOR

 Very unstable working conditions





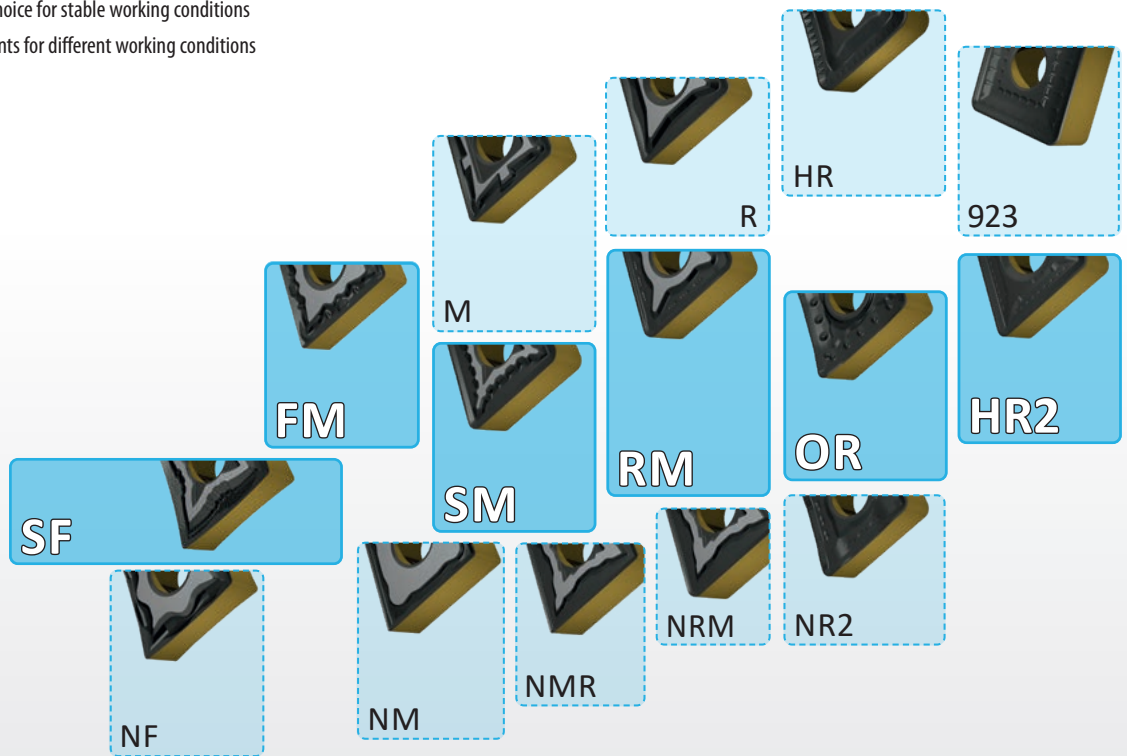

 Unstable working conditions

 Stable working conditions

 Thin-walled and slim workpieces

 1st choice for stable working conditions
 Variants for different working conditions



					
	0.05 – 0.2 mm/r		0.2 – 0.4 mm/r	0.4 – 1.0 mm/r	> 1.0 mm/r
	0.05 – 2 mm		2 – 4 mm	4 – 10 mm	> 10 mm



CCMT



	IC	D1	L	S
	(mm)	(mm)	(mm)	(mm)
0602	6.350	2.80	6.40	2.38
0803	7.940	3.40	8.10	3.18
09T3	9.525	4.40	9.70	3.97
1204	12.700	5.50	12.90	4.76

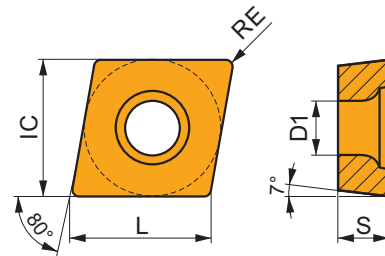

Suitability and starting values for cutting speed (vc), feed (f) and depth of cut (ap). Refer to our Machining Calculator app for further calculations.

Product	RE (mm)	P			M			K			N			S			H		
		vc (m/min)	f (mm/rev)	ap (mm)	vc (m/min)	f (mm/rev)	ap (mm)	vc (m/min)	f (mm/rev)	ap (mm)	vc (m/min)	f (mm/rev)	ap (mm)	vc (m/min)	f (mm/rev)	ap (mm)	vc (m/min)	f (mm/rev)	ap (mm)

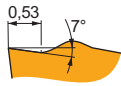
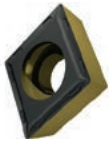

FF2 geometry with positive design for fine-finish to finish machining, and continuous to slightly interrupted cuts.

CCMT 060202E-FF2	T9415	0.2	395	0.05	0.8	–	–	–	375	0.05	0.8	–	–	–	–	–	–	–	–
CCMT 060204E-FF2	T9415	0.4	305	0.12	1.0	–	–	–	285	0.12	1.0	–	–	–	–	–	–	–	–
CCMT 09T304E-FF2	T9415	0.4	300	0.12	1.2	–	–	–	285	0.12	1.2	–	–	–	–	–	–	–	–
CCMT 09T308E-FF2	T9415	0.8	300	0.20	1.2	–	–	–	285	0.20	1.2	–	–	–	–	–	–	–	–

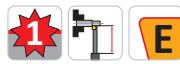
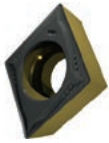

FM geometry for finish to semi-rough machining, and continuous to slightly interrupted cuts.

CCMT 060202E-FM	T9415	0.2	335	0.10	1.0	–	–	–	315	0.10	1.0	–	–	–	–	–	–	–	–
CCMT 060204E-FM	T9415	0.4	310	0.15	1.0	–	–	–	290	0.15	1.0	–	–	–	–	–	–	–	–
CCMT 060208E-FM	T9415	0.8	335	0.20	1.0	–	–	–	315	0.20	1.0	–	–	–	–	–	–	–	–
CCMT 09T302E-FM	T9415	0.2	330	0.10	1.2	–	–	–	310	0.10	1.2	–	–	–	–	–	–	–	–
CCMT 09T304E-FM	T9415	0.4	305	0.15	1.2	–	–	–	285	0.15	1.2	–	–	–	–	–	–	–	–
CCMT 09T308E-FM	T9415	0.8	330	0.20	1.2	–	–	–	310	0.20	1.2	–	–	–	–	–	–	–	–
CCMT 120404E-FM	T9415	0.4	295	0.15	1.7	–	–	–	280	0.15	1.7	–	–	–	–	–	–	–	–
CCMT 120408E-FM	T9415	0.8	315	0.20	1.7	–	–	–	295	0.20	1.7	–	–	–	–	–	–	–	–

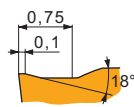
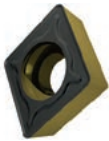

FM2 geometry for finish to medium machining, and continuous to interrupted cuts.

CCMT 080304E-FM2	T9415	0.4	305	0.12	1.0	–	–	–	285	0.12	1.0	–	–	–	–	–	–	–	–
CCMT 09T304E-FM2	T9415	0.4	305	0.12	1.0	–	–	–	285	0.12	1.0	–	–	–	–	–	–	–	–
CCMT 09T308E-FM2	T9415	0.8	320	0.17	1.0	–	–	–	300	0.17	1.0	–	–	–	–	–	–	–	–

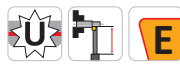
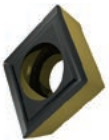

NF2 geometry with positive design for fine-finish to semi-rough machining, and continuous cuts.

CCMT 060204E-NF2	T9415	0.4	315	0.12	0.8	–	–	–	295	0.12	0.8	–	–	–	–	–	–	–	–
CCMT 080304E-NF2	T9415	0.4	305	0.12	1.0	–	–	–	285	0.12	1.0	–	–	–	–	–	–	–	–
CCMT 09T304E-NF2	T9415	0.4	300	0.12	1.2	–	–	–	285	0.12	1.2	–	–	–	–	–	–	–	–
CCMT 09T308E-NF2	T9415	0.8	340	0.14	1.2	–	–	–	320	0.14	1.2	–	–	–	–	–	–	–	–

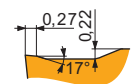
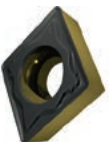

RM geometry for semi-rough to rough machining, and continuous to interrupted cuts.

CCMT 09T304E-RM	T9415	0.4	255	0.25	2.2	–	–	–	240	0.25	2.2	–	–	–	–	–	–	50	0.18	0.3
CCMT 09T308E-RM	T9415	0.8	285	0.30	2.2	–	–	–	270	0.30	2.2	–	–	–	–	–	–	55	0.15	0.7



Suitability and starting values for cutting speed (vc), feed (f) and depth of cut (ap). Refer to our Machining Calculator app for further calculations.

Product	RE (mm)	P			M			K			N			S			H		
		vc (m/min)	f (mm/rev)	ap (mm)	vc (m/min)	f (mm/rev)	ap (mm)	vc (m/min)	f (mm/rev)	ap (mm)	vc (m/min)	f (mm/rev)	ap (mm)	vc (m/min)	f (mm/rev)	ap (mm)	vc (m/min)	f (mm/rev)	ap (mm)

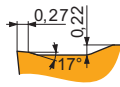
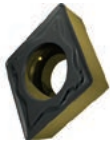

RM geometry for semi-rough to rough machining, and continuous to interrupted cuts.

CCMT 120408E-RM	T9415	0.8	280	0.30	2.7	–	–	–	265	0.30	2.7	–	–	–	–	–	–	55	0.15	0.7
CCMT 120412E-RM	T9415	1.2	280	0.33	2.7	–	–	–	265	0.33	2.7	–	–	–	–	–	–	55	0.17	1.0

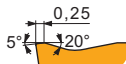
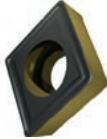

RM3 geometry for semi-rough to rough machining, and continuous to interrupted cuts.

CCMT 120404E-RM3	T9415	0.4	215	0.25	2.5	–	–	–	200	0.25	2.5	–	–	–	–	–	–	40	0.13	0.3
CCMT 120408E-RM3	T9415	0.8	250	0.27	2.5	–	–	–	235	0.27	2.5	–	–	–	–	–	–	50	0.14	0.7
CCMT 120412E-RM3	T9415	1.2	255	0.30	2.5	–	–	–	240	0.30	2.5	–	–	–	–	–	–	50	0.15	1.0

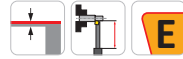
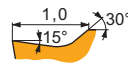
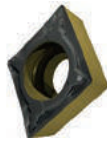

UR geometry for fine to finish machining, and continuous to slightly interrupted cuts.

CCMT 060202E-UR	T9415	0.2	295	0.10	0.8	–	–	–	280	0.10	0.8	–	–	–	–	–	–	–	–	–
CCMT 060204E-UR	T9415	0.4	270	0.15	1.0	–	–	–	255	0.15	1.0	–	–	–	–	–	–	–	–	–
CCMT 060208E-UR	T9415	0.8	290	0.20	1.0	–	–	–	275	0.20	1.0	–	–	–	–	–	–	–	–	–
CCMT 09T304E-UR	T9415	0.4	265	0.15	1.2	–	–	–	250	0.15	1.2	–	–	–	–	–	–	–	–	–
CCMT 09T308E-UR	T9415	0.8	285	0.20	1.2	–	–	–	270	0.20	1.2	–	–	–	–	–	–	–	–	–
CCMT 120404E-UR	T9415	0.4	255	0.15	1.7	–	–	–	240	0.15	1.7	–	–	–	–	–	–	–	–	–
CCMT 120408E-UR	T9415	0.8	275	0.20	1.7	–	–	–	260	0.20	1.7	–	–	–	–	–	–	–	–	–
CCMT 120412E-UR	T9415	1.2	265	0.27	1.7	–	–	–	250	0.27	1.7	–	–	–	–	–	–	–	–	–

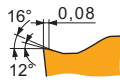
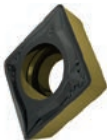

W-FM wiper geometry for fine to finish machining with increased feed rates and improved surface finish.

CCMT 060204W-FM	T9415	0.4	250	0.30	0.8	–	–	–	235	0.30	0.8	–	–	–	–	–	–	–	–	–
CCMT 09T304W-FM	T9415	0.4	305	0.15	1.2	–	–	–	285	0.15	1.2	–	–	–	–	–	–	–	–	–

CNMG



	IC (mm)	D1 (mm)	L (mm)	S (mm)
0903	9.525	3.81	9.70	3.18
1204	12.700	5.16	12.90	4.76
1606	15.875	6.35	16.10	6.35
1906	19.050	7.94	19.30	6.35
2509	25.400	9.12	25.80	9.53

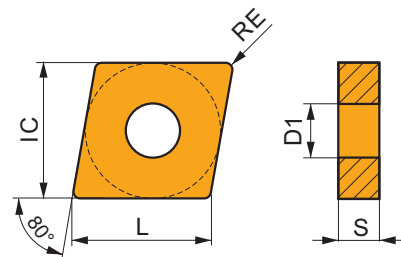

Suitability and starting values for cutting speed (vc), feed (f) and depth of cut (ap). Refer to our Machining Calculator app for further calculations.

Product	RE (mm)	P			M			K			N			S			H		
		vc (m/min)	f (mm/rev)	ap (mm)	vc (m/min)	f (mm/rev)	ap (mm)	vc (m/min)	f (mm/rev)	ap (mm)	vc (m/min)	f (mm/rev)	ap (mm)	vc (m/min)	f (mm/rev)	ap (mm)	vc (m/min)	f (mm/rev)	ap (mm)

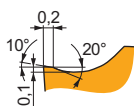

FM geometry with positive design for finish to semi-rough machining, and continuous to slightly interrupted cuts.

CNMG 090304E-FM	T9415	0.4	305	0.20	1.4	–	–	–	285	0.20	1.4	–	–	–	–	–	–	–	–	–
-----------------	-------	-----	-----	------	-----	---	---	---	-----	------	-----	---	---	---	---	---	---	---	---	---



Suitability and starting values for cutting speed (vc), feed (f) and depth of cut (ap). Refer to our Machining Calculator app for further calculations.

Product	RE (mm)	P			M			K			N			S			H		
		vc (m/min)	f (mm/rev)	ap (mm)	vc (m/min)	f (mm/rev)	ap (mm)	vc (m/min)	f (mm/rev)	ap (mm)	vc (m/min)	f (mm/rev)	ap (mm)	vc (m/min)	f (mm/rev)	ap (mm)	vc (m/min)	f (mm/rev)	ap (mm)

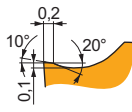
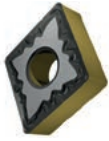

FM geometry with positive design for finish to semi-rough machining, and continuous to slightly interrupted cuts.

CNMG 090308E-FM	T9415	0.8	365	0.20	1.4	–	–	–	345	0.20	1.4	–	–	–	–	–	–	–	–
CNMG 120404E-FM	T9415	0.4	290	0.20	2.1	–	–	–	275	0.20	2.1	–	–	–	–	–	–	–	–
CNMG 120408E-FM	T9415	0.8	350	0.20	2.1	–	–	–	330	0.20	2.1	–	–	–	–	–	–	–	–
CNMG 120412E-FM	T9415	1.2	330	0.27	2.1	–	–	–	310	0.27	2.1	–	–	–	–	–	–	–	–

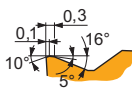
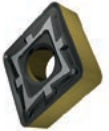

M geometry for finish to semi-rough machining, and continuous to interrupted cuts.

CNMG 090308E-M	T9415	0.8	275	0.32	1.8	–	–	–	260	0.32	1.8	–	–	–	–	–	55	0.16	0.5
CNMG 120404E-M	T9415	0.4	265	0.20	2.1	–	–	–	250	0.20	2.1	–	–	–	–	–	50	0.13	0.3
CNMG 120408E-M	T9415	0.8	270	0.32	2.1	–	–	–	255	0.32	2.1	–	–	–	–	–	50	0.16	0.7
CNMG 120412E-M	T9415	1.2	265	0.40	2.1	–	–	–	250	0.40	2.1	–	–	–	–	–	50	0.20	1.0
CNMG 160608E-M	T9415	0.8	255	0.32	3.6	–	–	–	240	0.32	3.6	–	–	–	–	–	50	0.16	0.7
CNMG 160612E-M	T9415	1.2	250	0.40	3.6	–	–	–	235	0.40	3.6	–	–	–	–	–	50	0.20	1.0
CNMG 190608E-M	T9415	0.8	250	0.32	4.2	–	–	–	235	0.32	4.2	–	–	–	–	–	50	0.16	0.7
CNMG 190612E-M	T9415	1.2	245	0.40	4.2	–	–	–	230	0.40	4.2	–	–	–	–	–	45	0.20	1.0
CNMG 190616E-M	T9415	1.6	255	0.40	4.2	–	–	–	240	0.40	4.2	–	–	–	–	–	50	0.20	1.3

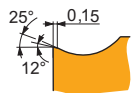
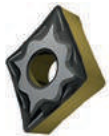

NF geometry with highly positive design for fine-finish to medium machining, and continuous cuts.

CNMG 120404E-NF	T9415	0.4	315	0.17	1.7	–	–	–	295	0.17	1.7	–	–	–	–	–	–	–	–
CNMG 120408E-NF	T9415	0.8	360	0.19	1.7	–	–	–	340	0.19	1.7	–	–	–	–	–	–	–	–
CNMG 120412E-NF	T9415	1.2	315	0.30	2.1	–	–	–	295	0.30	2.1	–	–	–	–	–	–	–	–

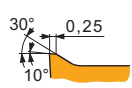
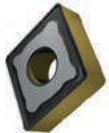

NM geometry with highly positive design for fine-finish, medium and rough machining, with continuous cuts.

CNMG 120404E-NM	T9415	0.4	305	0.20	2.1	–	–	–	–	–	–	–	–	–	–	–	–	–	–
CNMG 120408E-NM	T9415	0.8	335	0.25	2.1	–	–	–	–	–	–	–	–	–	–	–	–	–	–

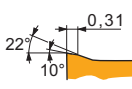

NMR geometry with positive design for medium to rough machining, and continuous cuts.

CNMG 120404E-NMR	T9415	0.4	245	0.25	2.0	–	–	–	–	–	–	–	–	–	–	–	–	–	–
CNMG 120408E-NMR	T9415	0.8	255	0.35	2.7	–	–	–	–	–	–	–	–	–	–	–	–	–	–
CNMG 120412E-NMR	T9415	1.2	255	0.40	2.7	–	–	–	–	–	–	–	–	–	–	–	–	–	–
CNMG 120416E-NMR	T8430	1.6	155	0.45	2.7	85	0.41	2.7	–	–	–	30	0.32	2.2	–	–	–	–	–
CNMG 160608E-NMR	T9415	0.8	245	0.35	4.0	–	–	–	–	–	–	–	–	–	–	–	–	–	–
CNMG 160612E-NMR	T9415	1.2	245	0.40	4.0	–	–	–	–	–	–	–	–	–	–	–	–	–	–
CNMG 160616E-NMR	T9415	1.6	240	0.45	6.0	–	–	–	–	–	–	–	–	–	–	–	–	–	–
CNMG 190608E-NMR	T9415	0.8	225	0.35	8.0	–	–	–	–	–	–	–	–	–	–	–	–	–	–
CNMG 190616E-NMR	T8430	1.6	145	0.45	5.2	80	0.41	5.2	–	–	–	30	0.32	4.2	–	–	–	–	–
	T9415	1.6	240	0.45	5.2	–	–	–	–	–	–	–	–	–	–	–	–	–	–

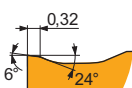

NRM geometry with positive design for semi-rough to rough machining, and continuous to moderate interrupted cuts.

CNMG 120408-NRM	T8430	0.8	150	0.35	4.0	80	0.32	4.0	–	–	–	30	0.25	3.2	–	–	–	–	–
	T9415	0.8	245	0.35	4.0	–	–	–	–	–	–	–	–	–	–	–	–	–	–
CNMG 120412-NRM	T8430	1.2	150	0.40	4.0	80	0.36	4.0	–	–	–	30	0.28	3.2	–	–	–	–	–
	T9415	1.2	245	0.40	4.0	–	–	–	–	–	–	–	–	–	–	–	–	–	–



Suitability and starting values for cutting speed (vc), feed (f) and depth of cut (ap). Refer to our Machining Calculator app for further calculations.

Product	RE (mm)	P			M			K			N			S			H		
		vc (m/min)	f (mm/rev)	ap (mm)	vc (m/min)	f (mm/rev)	ap (mm)	vc (m/min)	f (mm/rev)	ap (mm)	vc (m/min)	f (mm/rev)	ap (mm)	vc (m/min)	f (mm/rev)	ap (mm)	vc (m/min)	f (mm/rev)	ap (mm)

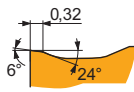

NRM geometry with positive design for semi-rough to rough machining, and continuous to moderate interrupted cuts.

CNMG 160608-NRM	T9415	0.8	235	0.35	6.0														
CNMG 160612-NRM	T9415	1.2	235	0.40	6.0														
CNMG 160616-NRM	T8430	1.6	145	0.45	6.0	80	0.41	6.0					30	0.32	4.8				
	T9415	1.6	240	0.45	6.0														
CNMG 190612-NRM	T8430	1.2	140	0.40	8.0	75	0.36	8.0					30	0.28	6.4				
	T9415	1.2	230	0.40	8.0														
CNMG 190616-NRM	T8430	1.6	140	0.45	8.0	75	0.41	8.0					30	0.32	6.4				
	T9415	1.6	230	0.45	8.0														

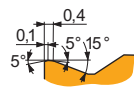
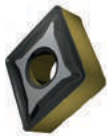

R geometry for semi-rough to rough machining, and continuous to interrupted cuts.

CNMG 120408E-R	T9415	0.8	230	0.40	4.0				215	0.40	4.0					45	0.20	0.7	
CNMG 120412E-R	T9415	1.2	235	0.45	4.0				220	0.45	4.0					45	0.23	1.0	
CNMG 160612E-R	T9415	1.2	230	0.45	5.5				215	0.45	5.5					45	0.23	1.0	
CNMG 190612E-R	T9415	1.2	225	0.45	7.0				210	0.45	7.0					45	0.23	1.0	
CNMG 190616E-R	T9415	1.6	225	0.50	7.0				210	0.50	7.0					45	0.25	1.3	

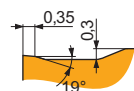

RM geometry for semi-rough to rough machining, and continuous to interrupted cuts.

CNMG 120408E-RM	T9415	0.8	265	0.40	4.0				250	0.40	4.0								
CNMG 120412E-RM	T9415	1.2	270	0.45	4.0				255	0.45	4.0								
CNMG 120416E-RM	T9415	1.6	275	0.50	4.0				260	0.50	4.0								
CNMG 160608E-RM	T9415	0.8	255	0.40	6.0				240	0.40	6.0								
CNMG 160612E-RM	T9415	1.2	260	0.45	6.0				245	0.45	6.0								
CNMG 160616E-RM	T9415	1.6	265	0.50	6.0				250	0.50	6.0								
CNMG 190608E-RM	T9415	0.8	250	0.40	7.5				235	0.40	7.5								
CNMG 190612E-RM	T9415	1.2	250	0.45	7.5				235	0.45	7.5								
CNMG 190616E-RM	T8430	1.6	150	0.50	7.5	80	0.45	7.5	125	0.50	7.5		30	0.35	6.0				
	T9415	1.6	255	0.50	7.5				240	0.50	7.5								
CNMG 250924E-RM	T9415	2.4	125	0.80	12.0				115	0.80	12.0								

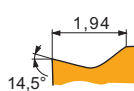
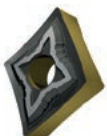

SF geometry with positive design for fine-finish machining of thin walls and continuous cuts.

CNMG 120404E-SF	T9415	0.4	315	0.17	1.0				295	0.17	1.0					60	0.13	0.3	
-----------------	-------	-----	-----	------	-----	--	--	--	-----	------	-----	--	--	--	--	----	------	-----	--

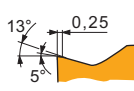
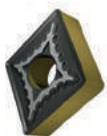

SM geometry with positive design for medium machining, and continuous to interrupted cuts.

CNMG 120404E-SM	T9415	0.4	280	0.20	2.0				265	0.20	2.0					55	0.13	0.3	
CNMG 120408E-SM	T9415	0.8	305	0.25	2.0				285	0.25	2.0					60	0.13	0.7	
CNMG 120412E-SM	T9415	1.2	300	0.30	2.0				285	0.30	2.0					60	0.15	1.0	
CNMG 160612E-SM	T9415	1.2	290	0.30	3.0				275	0.30	3.0					55	0.15	1.0	
CNMG 190612E-SM	T9415	1.2	280	0.30	4.0				265	0.30	4.0					55	0.15	1.0	

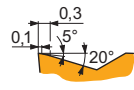
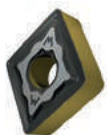

W-M wiper geometry for semi-rough to rough machining with increased feed rates and improved surface finish.

CNMG 120408W-M	T9415	0.8	245	0.45	1.5				230	0.45	1.5								
----------------	-------	-----	-----	------	-----	--	--	--	-----	------	-----	--	--	--	--	--	--	--	--



Suitability and starting values for cutting speed (vc), feed (f) and depth of cut (ap). Refer to our Machining Calculator app for further calculations.

Product	RE (mm)	P			M			K			N			S			H		
		vc (m/min)	f (mm/rev)	ap (mm)	vc (m/min)	f (mm/rev)	ap (mm)	vc (m/min)	f (mm/rev)	ap (mm)	vc (m/min)	f (mm/rev)	ap (mm)	vc (m/min)	f (mm/rev)	ap (mm)	vc (m/min)	f (mm/rev)	ap (mm)

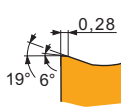
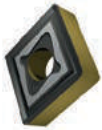

W-MR wiper geometry for finish to rough machining with increased feed rates and improved surface finish.

CNMG 120404W-MR	T9415	0.4	240	0.30	1.5	—	—	—	225	0.30	1.5	—	—	—	—	—	—	—
CNMG 120408W-MR	T9415	0.8	245	0.45	1.5	—	—	—	230	0.45	1.5	—	—	—	—	—	—	—
CNMG 120412W-MR	T9415	1.2	245	0.55	1.5	—	—	—	230	0.55	1.5	—	—	—	—	—	—	—

CNMM



	IC (mm)	D1 (mm)	L (mm)	S (mm)
1204	12.700	5.16	12.90	4.76
1606	15.875	6.35	16.10	6.35
1906	19.050	7.94	19.30	6.35
2509	25.400	9.12	25.80	9.53

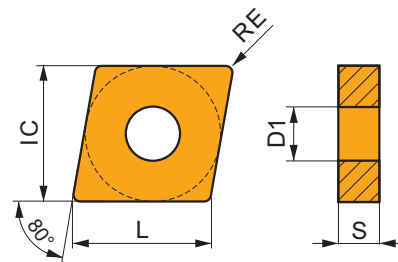

Suitability and starting values for cutting speed (vc), feed (f) and depth of cut (ap). Refer to our Machining Calculator app for further calculations.

Product	RE (mm)	P			M			K			N			S			H		
		vc (m/min)	f (mm/rev)	ap (mm)	vc (m/min)	f (mm/rev)	ap (mm)	vc (m/min)	f (mm/rev)	ap (mm)	vc (m/min)	f (mm/rev)	ap (mm)	vc (m/min)	f (mm/rev)	ap (mm)	vc (m/min)	f (mm/rev)	ap (mm)

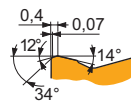
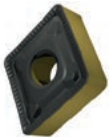

HR geometry for rough to heavy-rough machining, and continuous to interrupted cuts.

CNMM 190624E-HR	T9415	2.4	120	0.65	10.0	—	—	—	110	0.65	10.0	—	—	—	—	—	—	—
CNMM 250924E-HR	T9415	2.4	120	0.65	14.0	—	—	—	110	0.65	14.0	—	—	—	—	—	—	—

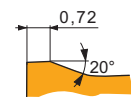
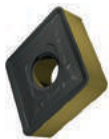

HR2 geometry for rough to heavy-rough machining, and continuous to interrupted cuts.

CNMM 190616-HR2	T9415	1.6	115	0.65	10.0	—	—	—	105	0.65	10.0	—	—	—	—	—	—	—
CNMM 190624-HR2	T9415	2.4	110	0.85	10.0	—	—	—	100	0.85	10.0	—	—	—	—	—	—	—
CNMM 250924-HR2	T9415	2.4	110	0.85	12.0	—	—	—	100	0.85	12.0	—	—	—	—	—	—	—

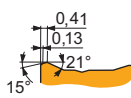

NR2 geometry for semi-rough to rough machining, and continuous to interrupted cuts.

CNMM 120408E-NR2	T9415	0.8	250	0.40	5.0	—	—	—	235	0.40	5.0	—	—	—	—	—	—	—
CNMM 190616E-NR2	T9415	1.6	240	0.50	9.0	—	—	—	225	0.50	9.0	—	—	—	—	—	—	—
CNMM 250924E-NR2	T9415	2.4	120	0.80	12.0	—	—	—	110	0.80	12.0	—	—	—	—	—	—	—

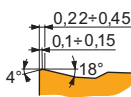

OR geometry for semi-rough to rough machining, and continuous to interrupted cuts.

CNMM 120408E-OR	T9415	0.8	250	0.40	5.0	—	—	—	235	0.40	5.0	—	—	—	—	—	—	—
CNMM 120412E-OR	T9415	1.2	250	0.45	5.0	—	—	—	235	0.45	5.0	—	—	—	—	—	—	—
CNMM 160608E-OR	T9415	0.8	245	0.40	6.0	—	—	—	230	0.40	6.0	—	—	—	—	—	—	—
CNMM 160612E-OR	T9415	1.2	250	0.45	6.0	—	—	—	235	0.45	6.0	—	—	—	—	—	—	—
CNMM 160616E-OR	T9415	1.6	250	0.50	6.0	—	—	—	235	0.50	6.0	—	—	—	—	—	—	—



Suitability and starting values for cutting speed (vc), feed (f) and depth of cut (ap). Refer to our Machining Calculator app for further calculations.

Product	RE (mm)	P			M			K			N			S			H		
		vc (m/min)	f (mm/rev)	ap (mm)	vc (m/min)	f (mm/rev)	ap (mm)	vc (m/min)	f (mm/rev)	ap (mm)	vc (m/min)	f (mm/rev)	ap (mm)	vc (m/min)	f (mm/rev)	ap (mm)	vc (m/min)	f (mm/rev)	ap (mm)

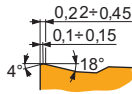
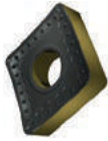

OR geometry for semi-rough to rough machining, and continuous to interrupted cuts.

CNMM 190612E-OR	T9415	1.2	240	0.45	9.0	—	—	—	225	0.45	9.0	—	—	—	—	—	—	—	—
CNMM 190616E-OR	T9415	1.6	240	0.50	9.0	—	—	—	225	0.50	9.0	—	—	—	—	—	—	—	—
CNMM 190624E-OR	T9415	2.4	215	0.80	9.0	—	—	—	200	0.80	9.0	—	—	—	—	—	—	—	—
CNMM 250924E-OR	T9415	2.4	110	1.00	12.0	—	—	—	100	1.00	12.0	—	—	—	—	—	—	—	—

DCMT



	IC (mm)	D1 (mm)	L (mm)	S (mm)
0702	6.350	2.80	7.80	2.38
11T3	9.525	4.40	11.60	3.97
1504	12.700	5.50	15.50	4.76

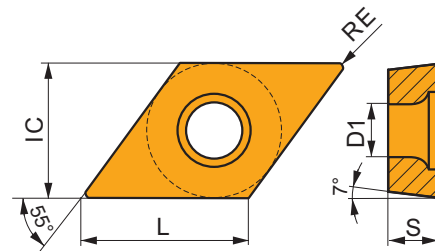

Suitability and starting values for cutting speed (vc), feed (f) and depth of cut (ap). Refer to our Machining Calculator app for further calculations.

Product	RE (mm)	P			M			K			N			S			H		
		vc (m/min)	f (mm/rev)	ap (mm)	vc (m/min)	f (mm/rev)	ap (mm)	vc (m/min)	f (mm/rev)	ap (mm)	vc (m/min)	f (mm/rev)	ap (mm)	vc (m/min)	f (mm/rev)	ap (mm)	vc (m/min)	f (mm/rev)	ap (mm)

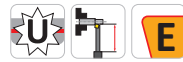
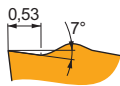

FF2 geometry with positive design for fine-finish to finish machining, and continuous to slightly interrupted cuts.

DCMT 070204E-FF2	T9415	0.4	250	0.12	0.8	—	—	—	235	0.12	0.8	—	—	—	—	—	—	—	—
DCMT 070208E-FF2	T9415	0.8	265	0.17	0.8	—	—	—	250	0.17	0.8	—	—	—	—	—	—	—	—
DCMT 11T304E-FF2	T9415	0.4	250	0.12	0.8	—	—	—	235	0.12	0.8	—	—	—	—	—	—	—	—
DCMT 11T308E-FF2	T9415	0.8	265	0.17	0.8	—	—	—	250	0.17	0.8	—	—	—	—	—	—	—	—

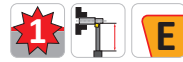

FM geometry for finish to semi-rough machining, and continuous to slightly interrupted cuts.

DCMT 070202E-FM	T9415	0.2	275	0.10	0.8	—	—	—	260	0.10	0.8	—	—	—	—	—	—	—	—
DCMT 070204E-FM	T9415	0.4	275	0.12	0.8	—	—	—	260	0.12	0.8	—	—	—	—	—	—	—	—
DCMT 11T302E-FM	T9415	0.2	275	0.10	0.8	—	—	—	260	0.10	0.8	—	—	—	—	—	—	—	—
DCMT 11T304E-FM	T9415	0.4	275	0.12	0.8	—	—	—	260	0.12	0.8	—	—	—	—	—	—	—	—
DCMT 11T308E-FM	T9415	0.8	290	0.17	0.8	—	—	—	275	0.17	0.8	—	—	—	—	—	—	—	—
DCMT 11T312E-FM	T9415	1.2	265	0.22	1.2	—	—	—	250	0.22	1.2	—	—	—	—	—	—	—	—

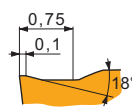
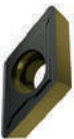

FM2 geometry for finish to medium machining, and continuous to interrupted cuts.

DCMT 070204E-FM2	T9415	0.4	250	0.12	0.8	—	—	—	235	0.12	0.8	—	—	—	—	—	—	—	—
DCMT 11T304E-FM2	T9415	0.4	250	0.12	0.8	—	—	—	235	0.12	0.8	—	—	—	—	—	—	—	—
DCMT 11T308E-FM2	T9415	0.8	265	0.17	0.8	—	—	—	250	0.17	0.8	—	—	—	—	—	—	—	—



Suitability and starting values for cutting speed (vc), feed (f) and depth of cut (ap). Refer to our Machining Calculator app for further calculations.

Product	RE (mm)	P			M			K			N			S			H		
		vc (m/min)	f (mm/rev)	ap (mm)	vc (m/min)	f (mm/rev)	ap (mm)	vc (m/min)	f (mm/rev)	ap (mm)	vc (m/min)	f (mm/rev)	ap (mm)	vc (m/min)	f (mm/rev)	ap (mm)	vc (m/min)	f (mm/rev)	ap (mm)

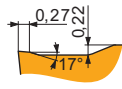

RM geometry for semi-rough to rough machining, and continuous to interrupted cuts.

DCMT 11T304E-RM	T9415	0.4	235	0.20	1.0	—	—	—	220	0.20	1.0	—	—	—	—	—	—	45	0.14	0.3
DCMT 11T308E-RM	T9415	0.8	255	0.27	1.0	—	—	—	240	0.27	1.0	—	—	—	—	—	—	50	0.14	0.7
DCMT 11T312E-RM	T9415	1.2	260	0.27	1.2	—	—	—	245	0.27	1.2	—	—	—	—	—	—	50	0.14	0.9
DCMT 150408E-RM	T9415	0.8	235	0.27	1.9	—	—	—	220	0.27	1.9	—	—	—	—	—	—	45	0.14	0.7

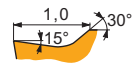

UR geometry for fine to finish machining, and continuous to slightly interrupted cuts.

DCMT 070202E-UR	T9415	0.2	235	0.10	0.8	—	—	—	220	0.10	0.8	—	—	—	—	—	—	—	—	—
DCMT 070204E-UR	T9415	0.4	240	0.12	0.8	—	—	—	225	0.12	0.8	—	—	—	—	—	—	—	—	—
DCMT 11T302E-UR	T9415	0.2	235	0.10	0.8	—	—	—	220	0.10	0.8	—	—	—	—	—	—	—	—	—
DCMT 11T304E-UR	T9415	0.4	240	0.12	0.8	—	—	—	225	0.12	0.8	—	—	—	—	—	—	—	—	—
DCMT 11T308E-UR	T9415	0.8	250	0.17	0.8	—	—	—	235	0.17	0.8	—	—	—	—	—	—	—	—	—
DCMT 11T312E-UR	T9415	1.2	230	0.22	1.2	—	—	—	215	0.22	1.2	—	—	—	—	—	—	—	—	—

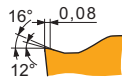

W-FM wiper geometry for fine to finish machining with increased feed rates and improved surface finish.

DCMX 11T304W-FM	T9415	0.4	200	0.30	0.8	—	—	—	190	0.30	0.8	—	—	—	—	—	—	—	—	—
-----------------	-------	-----	-----	------	-----	---	---	---	-----	------	-----	---	---	---	---	---	---	---	---	---

DNMG



	IC (mm)	D1 (mm)	L (mm)	S (mm)
1104	9.525	3.81	11.60	4.76
1504	12.700	5.16	15.50	4.76
1506	12.700	5.16	15.50	6.35

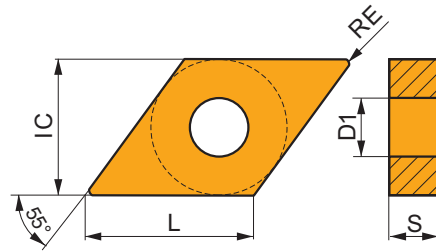

Suitability and starting values for cutting speed (vc), feed (f) and depth of cut (ap). Refer to our Machining Calculator app for further calculations.

Product	RE (mm)	P			M			K			N			S			H		
		vc (m/min)	f (mm/rev)	ap (mm)	vc (m/min)	f (mm/rev)	ap (mm)	vc (m/min)	f (mm/rev)	ap (mm)	vc (m/min)	f (mm/rev)	ap (mm)	vc (m/min)	f (mm/rev)	ap (mm)	vc (m/min)	f (mm/rev)	ap (mm)

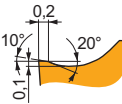

FM geometry with positive design for finish to semi-rough machining, and continuous to slightly interrupted cuts.

DNMG 110404E-FM	T9415	0.4	260	0.20	0.8	—	—	—	245	0.20	0.8	—	—	—	—	—	—	—	—	—
DNMG 110408E-FM	T9415	0.8	305	0.20	0.8	—	—	—	285	0.20	0.8	—	—	—	—	—	—	—	—	—
DNMG 150404E-FM	T9415	0.4	235	0.20	1.7	—	—	—	220	0.20	1.7	—	—	—	—	—	—	—	—	—
DNMG 150408E-FM	T9415	0.8	280	0.20	1.7	—	—	—	265	0.20	1.7	—	—	—	—	—	—	—	—	—
DNMG 150604E-FM	T9415	0.4	235	0.20	1.7	—	—	—	220	0.20	1.7	—	—	—	—	—	—	—	—	—
DNMG 150608E-FM	T9415	0.8	280	0.20	1.7	—	—	—	265	0.20	1.7	—	—	—	—	—	—	—	—	—
DNMG 150612E-FM	T9415	1.2	275	0.25	1.7	—	—	—	260	0.25	1.7	—	—	—	—	—	—	—	—	—
DNMG 150616E-FM	T9415	1.6	270	0.30	1.7	—	—	—	255	0.30	1.7	—	—	—	—	—	—	—	—	—



Suitability and starting values for cutting speed (vc), feed (f) and depth of cut (ap). Refer to our Machining Calculator app for further calculations.

Product	RE (mm)	P			M			K			N			S			H		
		vc (m/min)	f (mm/rev)	ap (mm)	vc (m/min)	f (mm/rev)	ap (mm)	vc (m/min)	f (mm/rev)	ap (mm)	vc (m/min)	f (mm/rev)	ap (mm)	vc (m/min)	f (mm/rev)	ap (mm)	vc (m/min)	f (mm/rev)	ap (mm)

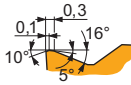

M geometry for finish to semi-rough machining, and continuous to interrupted cuts.

DNMG 110404E-M	T9415	0.4	225	0.20	1.2	-	-	-	210	0.20	1.2	-	-	-	-	-	-	45	0.14	0.3
DNMG 110408E-M	T9415	0.8	235	0.30	1.2	-	-	-	220	0.30	1.2	-	-	-	-	-	-	45	0.15	0.7
DNMG 110412E-M	T9415	1.2	220	0.40	1.2	-	-	-	205	0.40	1.2	-	-	-	-	-	-	40	0.20	0.9
DNMG 150404E-M	T9415	0.4	210	0.20	1.9	-	-	-	195	0.20	1.9	-	-	-	-	-	-	40	0.14	0.3
DNMG 150408E-M	T9415	0.8	220	0.30	1.9	-	-	-	205	0.30	1.9	-	-	-	-	-	-	40	0.15	0.7
DNMG 150412E-M	T9415	1.2	210	0.40	1.9	-	-	-	195	0.40	1.9	-	-	-	-	-	-	40	0.20	0.9
DNMG 150604E-M	T9415	0.4	210	0.20	1.9	-	-	-	195	0.20	1.9	-	-	-	-	-	-	40	0.14	0.3
DNMG 150608E-M	T9415	0.8	220	0.30	1.9	-	-	-	205	0.30	1.9	-	-	-	-	-	-	40	0.15	0.7
DNMG 150612E-M	T9415	1.2	210	0.40	1.9	-	-	-	195	0.40	1.9	-	-	-	-	-	-	40	0.20	0.9

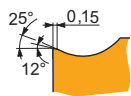

NF geometry with highly positive design for fine-finish to medium machining, and continuous cuts.

DNMG 110408E-NF	T9415	0.8	315	0.17	1.0	-	-	-	295	0.17	1.0	-	-	-	-	-	-	-	-	-
DNMG 150404E-NF	T9415	0.4	260	0.15	1.7	-	-	-	245	0.15	1.7	-	-	-	-	-	-	-	-	-
DNMG 150408E-NF	T9415	0.8	300	0.17	1.7	-	-	-	285	0.17	1.7	-	-	-	-	-	-	-	-	-
DNMG 150604E-NF	T9415	0.4	260	0.15	1.9	-	-	-	245	0.15	1.9	-	-	-	-	-	-	-	-	-
DNMG 150608E-NF	T9415	0.8	295	0.17	1.9	-	-	-	280	0.17	1.9	-	-	-	-	-	-	-	-	-

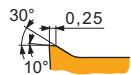
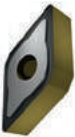

NM geometry with highly positive design for fine-finish, medium to rough machining, and continuous cuts.

DNMG 150608E-NM	T9415	0.8	275	0.25	1.9	-	-	-	-	-	-	-	-	-	-	-	-	-	-	-
-----------------	-------	-----	-----	------	-----	---	---	---	---	---	---	---	---	---	---	---	---	---	---	---

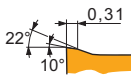
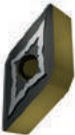

NMR geometry with positive design for medium to rough machining, and continuous cuts.

DNMG 110408E-NMR	T9415	0.8	240	0.30	0.8	-	-	-	-	-	-	-	-	-	-	-	-	-	-	-
DNMG 150408E-NMR	T9415	0.8	220	0.30	1.9	-	-	-	-	-	-	-	-	-	-	-	-	-	-	-
DNMG 150604E-NMR	T9415	0.4	210	0.20	1.9	-	-	-	-	-	-	-	-	-	-	-	-	-	-	-
DNMG 150608E-NMR	T9415	0.8	220	0.30	1.9	-	-	-	-	-	-	-	-	-	-	-	-	-	-	-
DNMG 150612E-NMR	T9415	1.2	235	0.30	1.9	-	-	-	-	-	-	-	-	-	-	-	-	-	-	-

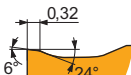

NRM geometry with positive design for semi-rough to rough machining, and continuous to moderate interrupted cuts.

DNMG 150608-NRM	T9415	0.8	210	0.30	3.0	-	-	-	-	-	-	-	-	-	-	-	-	-	-	-
-----------------	-------	-----	-----	------	-----	---	---	---	---	---	---	---	---	---	---	---	---	---	---	---

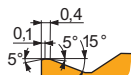

R geometry for semi-rough to rough machining, and continuous to interrupted cuts.

DNMG 150608E-R	T9415	0.8	190	0.40	3.0	-	-	-	180	0.40	3.0	-	-	-	-	-	-	35	0.20	0.7
DNMG 150612E-R	T9415	1.2	200	0.40	3.0	-	-	-	190	0.40	3.0	-	-	-	-	-	-	40	0.20	0.9

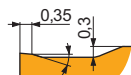

RM geometry for semi-rough to rough machining, and continuous to interrupted cuts.

DNMG 110408E-RM	T9415	0.8	230	0.40	2.0	-	-	-	215	0.40	2.0	-	-	-	-	-	-	-	-	-
DNMG 110412E-RM	T9415	1.2	265	0.30	2.0	-	-	-	250	0.30	2.0	-	-	-	-	-	-	-	-	-
DNMG 150408E-RM	T9415	0.8	220	0.40	3.0	-	-	-	205	0.40	3.0	-	-	-	-	-	-	-	-	-
DNMG 150412E-RM	T9415	1.2	230	0.40	3.0	-	-	-	215	0.40	3.0	-	-	-	-	-	-	-	-	-



Suitability and starting values for cutting speed (vc), feed (f) and depth of cut (ap). Refer to our Machining Calculator app for further calculations.

Product	RE (mm)	P			M			K			N			S			H		
		vc (m/min)	f (mm/rev)	ap (mm)	vc (m/min)	f (mm/rev)	ap (mm)	vc (m/min)	f (mm/rev)	ap (mm)	vc (m/min)	f (mm/rev)	ap (mm)	vc (m/min)	f (mm/rev)	ap (mm)	vc (m/min)	f (mm/rev)	ap (mm)

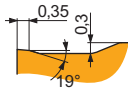

RM geometry for semi-rough to rough machining, and continuous to interrupted cuts.

DNMG 150608E-RM	T9415	0.8	220	0.40	3.0	—	—	—	205	0.40	3.0	—	—	—	—	—	—	—	—
DNMG 150612E-RM	T9415	1.2	230	0.40	3.0	—	—	—	215	0.40	3.0	—	—	—	—	—	—	—	—
DNMG 150616E-RM	T9415	1.6	245	0.40	3.0	—	—	—	230	0.40	3.0	—	—	—	—	—	—	—	—

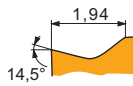

SF geometry with positive design for fine-finish machining of thin walls and continuous cuts.

DNMG 150608E-SF	T9415	0.8	290	0.17	1.5	—	—	—	275	0.17	1.5	—	—	—	—	—	55	0.12	0.7
-----------------	-------	-----	-----	------	-----	---	---	---	-----	------	-----	---	---	---	---	---	----	------	-----

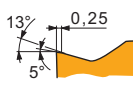

SM geometry with positive design for medium machining, and continuous to interrupted cuts.

DNMG 150604E-SM	T9415	0.4	225	0.20	1.7	—	—	—	210	0.20	1.7	—	—	—	—	—	45	0.14	0.3
DNMG 150608E-SM	T9415	0.8	250	0.25	1.7	—	—	—	235	0.25	1.7	—	—	—	—	—	50	0.13	0.7
DNMG 150612E-SM	T9415	1.2	245	0.30	1.7	—	—	—	230	0.30	1.7	—	—	—	—	—	45	0.15	0.9

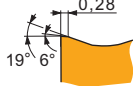

W-MR wiper geometry for finish to rough machining with increased feed rates and improved surface finish.

DNMG 150608W-MR	T9415	0.8	205	0.40	1.5	—	—	—	190	0.40	1.5	—	—	—	—	—	—	—	—
DNMG 150612W-MR	T9415	1.2	200	0.50	1.5	—	—	—	190	0.50	1.5	—	—	—	—	—	—	—	—

DNMM



	IC (mm)	D1 (mm)	L (mm)	S (mm)
1506	12.700	5.16	15.50	6.35

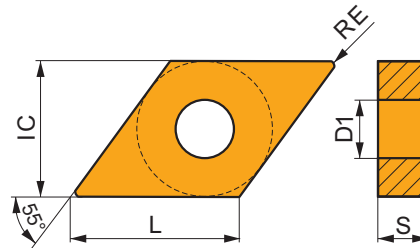

Suitability and starting values for cutting speed (vc), feed (f) and depth of cut (ap). Refer to our Machining Calculator app for further calculations.

Product	RE (mm)	P			M			K			N			S			H		
		vc (m/min)	f (mm/rev)	ap (mm)	vc (m/min)	f (mm/rev)	ap (mm)	vc (m/min)	f (mm/rev)	ap (mm)	vc (m/min)	f (mm/rev)	ap (mm)	vc (m/min)	f (mm/rev)	ap (mm)	vc (m/min)	f (mm/rev)	ap (mm)

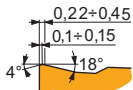

OR geometry for semi-rough to rough machining, and continuous to interrupted cuts.

DNMM 150612E-OR	T9415	1.2	220	0.40	3.0	—	—	—	205	0.40	3.0	—	—	—	—	—	—	—	—
-----------------	-------	-----	-----	------	-----	---	---	---	-----	------	-----	---	---	---	---	---	---	---	---



ECMT

	IC (mm)	D1 (mm)	L (mm)	S (mm)
0602	6.350	2.80	6.50	2.38
0803	7.940	3.40	8.20	3.18

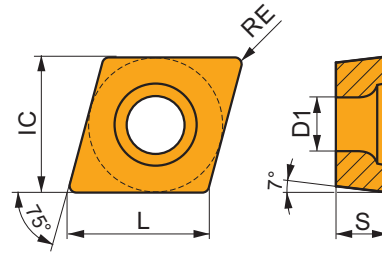

Suitability and starting values for cutting speed (vc), feed (f) and depth of cut (ap). Refer to our Machining Calculator app for further calculations.

Product	RE (mm)	P			M			K			N			S			H		
		vc (m/min)	f (mm/rev)	ap (mm)	vc (m/min)	f (mm/rev)	ap (mm)	vc (m/min)	f (mm/rev)	ap (mm)	vc (m/min)	f (mm/rev)	ap (mm)	vc (m/min)	f (mm/rev)	ap (mm)	vc (m/min)	f (mm/rev)	ap (mm)

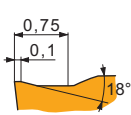
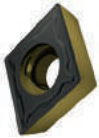

FM2 geometry for finish to medium machining, and continuous to interrupted cuts.

ECMT 060204E-FM2	T9415	0.4	285	0.12	0.8	–	–	–	270	0.12	0.8	–	–	–	–	–	–	–	–
ECMT 080304E-FM2	T9415	0.4	275	0.12	1.0	–	–	–	260	0.12	1.0	–	–	–	–	–	–	–	–
ECMT 080308E-FM2	T9415	0.8	290	0.17	1.0	–	–	–	275	0.17	1.0	–	–	–	–	–	–	–	–

EPMT

	IC (mm)	D1 (mm)	L (mm)	S (mm)
0502	5.560	2.50	5.70	2.38

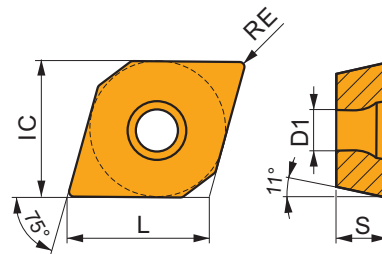

Suitability and starting values for cutting speed (vc), feed (f) and depth of cut (ap). Refer to our Machining Calculator app for further calculations.

Product	RE (mm)	P			M			K			N			S			H		
		vc (m/min)	f (mm/rev)	ap (mm)	vc (m/min)	f (mm/rev)	ap (mm)	vc (m/min)	f (mm/rev)	ap (mm)	vc (m/min)	f (mm/rev)	ap (mm)	vc (m/min)	f (mm/rev)	ap (mm)	vc (m/min)	f (mm/rev)	ap (mm)

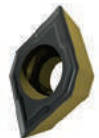

NF2 geometry with positive design for fine-finish to semi-rough machining, and continuous cuts.

EPMT 050202E-NF2	T9415	0.2	355	0.05	0.8	–	–	–	335	0.05	0.8	–	–	–	–	–	–	–	–
------------------	-------	-----	-----	------	-----	---	---	---	-----	------	-----	---	---	---	---	---	---	---	---



RCMT



	INSD (mm)	D1 (mm)	S (mm)
0602	6.000	2.80	2.38
0803	8.000	3.40	3.18
10T3	10.000	4.40	3.97
1204	12.000	4.40	4.76
1606	16.000	5.50	6.35
2006	20.000	6.50	6.35
3009	30.000	10.00	9.53

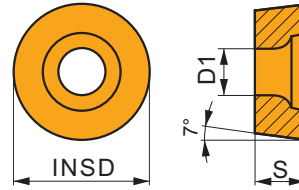

Suitability and starting values for cutting speed (vc), feed (f) and depth of cut (ap). Refer to our Machining Calculator app for further calculations.

Product	RE (mm)	P			M			K			N			S			H		
		vc (m/min)	f (mm/rev)	ap (mm)	vc (m/min)	f (mm/rev)	ap (mm)	vc (m/min)	f (mm/rev)	ap (mm)	vc (m/min)	f (mm/rev)	ap (mm)	vc (m/min)	f (mm/rev)	ap (mm)	vc (m/min)	f (mm/rev)	ap (mm)

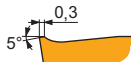
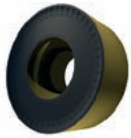

Geometry 37 for semi-rough to heavy-rough machining, and continuous to interrupted cuts.

RCMT 1606MOS-37	T9415	-	200	0.60	3.0	-	-	-	190	0.60	3.0	-	-	-	-	-	-	-	-
-----------------	-------	---	-----	------	-----	---	---	---	-----	------	-----	---	---	---	---	---	---	---	---

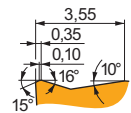

Geometry 371 for semi-rough to heavy-rough machining, and continuous to interrupted cuts.

RCMT 2006MOS-371	T9415	-	185	0.80	3.0	-	-	-	175	0.80	3.0	-	-	-	-	-	-	-	-
------------------	-------	---	-----	------	-----	---	---	---	-----	------	-----	---	---	---	---	---	---	---	---

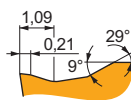

FM geometry for finish to semi-rough machining, and continuous to slightly interrupted cuts.

RCMT 0602MOE-FM	T9415	-	320	0.45	1.2	-	-	-	300	0.45	1.2	-	-	-	-	-	-	-	-
RCMT 0803MOE-FM	T9415	-	280	0.60	1.6	-	-	-	265	0.60	1.6	-	-	-	-	-	-	-	-
RCMT 10T3MOE-FM	T9415	-	275	0.65	1.7	-	-	-	260	0.65	1.7	-	-	-	-	-	-	-	-
RCMT 1204MOE-FM	T9415	-	260	0.70	1.8	-	-	-	245	0.70	1.8	-	-	-	-	-	-	-	-

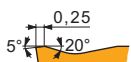
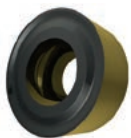

RM3 geometry for semi-rough to rough machining, and continuous to interrupted cuts.

RCMT 0803MOE-RM3	T9415	-	275	0.50	1.3	-	-	-	260	0.50	1.3	-	-	-	-	-	55	0.25	0.5
RCMT 1204MOE-RM3	T9415	-	255	0.60	1.8	-	-	-	240	0.60	1.8	-	-	-	-	-	50	0.30	0.8
RCMT 1606MOE-RM3	T9415	-	245	0.65	2.0	-	-	-	230	0.65	2.0	-	-	-	-	-	45	0.33	1.1

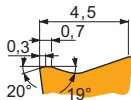
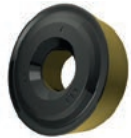

RR4 geometry for heavy rough machining, and continuous to heavy interrupted cuts.

RCMT 3009MO-RR4	T9415	-	95	1.10	4.0	-	-	-	90	1.10	4.0	-	-	-	-	-	-	-	-
-----------------	-------	---	----	------	-----	---	---	---	----	------	-----	---	---	---	---	---	---	---	---

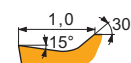
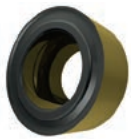

UR geometry for fine to finish machining, and continuous to slightly interrupted cuts.

RCMT 0602MOE-UR	T9415	-	285	0.40	1.2	-	-	-	270	0.40	1.2	-	-	-	-	-	-	-	-
RCMT 0803MOE-UR	T9415	-	265	0.45	1.6	-	-	-	250	0.45	1.6	-	-	-	-	-	-	-	-
RCMT 10T3MOE-UR	T9415	-	260	0.50	1.4	-	-	-	245	0.50	1.4	-	-	-	-	-	-	-	-
RCMT 1204MOE-UR	T9415	-	245	0.55	1.8	-	-	-	230	0.55	1.8	-	-	-	-	-	-	-	-









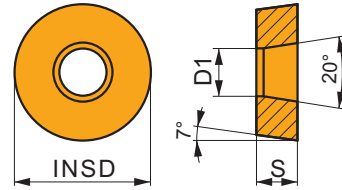



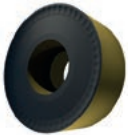
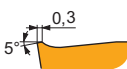
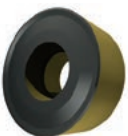
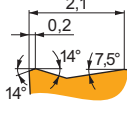

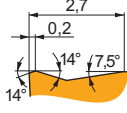
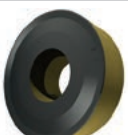
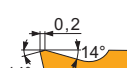
RCMX

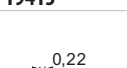

	INSD (mm)	D1 (mm)	S (mm)
1204	12.000	4.20	4.76
1606	16.000	5.20	6.35
2006	20.000	6.50	6.35
2507	25.000	7.20	7.94
3209	32.000	9.50	9.53



Suitability and starting values for cutting speed (vc), feed (f) and depth of cut (ap). Refer to our Machining Calculator app for further calculations.

Product	RE (mm)	P			M			K			N			S			H		
		vc (m/min)	f (mm/rev)	ap (mm)	vc (m/min)	f (mm/rev)	ap (mm)	vc (m/min)	f (mm/rev)	ap (mm)	vc (m/min)	f (mm/rev)	ap (mm)	vc (m/min)	f (mm/rev)	ap (mm)	vc (m/min)	f (mm/rev)	ap (mm)
  Geometry 37 for semi-rough to heavy-rough machining, and continuous to interrupted cuts.	T9415	-	200	0.60	3.0	-	-	-	190	0.60	3.0	-	-	-	-	-	-	-	-
  Geometry 321 for semi-rough to heavy-rough machining, and continuous to interrupted cuts.	T9415	-	170	1.00	3.0	-	-	-	160	1.00	3.0	-	-	-	-	-	-	-	-
  Geometry 331 for semi-rough to heavy-rough machining, and continuous to interrupted cuts.	T9415	-	155	1.20	3.5	-	-	-	145	1.20	3.5	-	-	-	-	-	-	-	-
  RF1 geometry for finish to semi-rough machining, and continuous to interrupted cuts.	T9415	-	105	0.80	3.5	-	-	-	95	0.80	3.5	-	-	-	-	-	-	-	-
  RF1 geometry for finish to semi-rough machining, and continuous to interrupted cuts.	T9415	-	100	1.00	3.5	-	-	-	95	1.00	3.5	-	-	-	-	-	-	-	-
  RM1 geometry for finish to rough machining, and continuous to interrupted cuts.	T9415	-	100	1.00	3.5	-	-	-	95	1.00	3.5	-	-	-	-	-	-	-	-
  RM1 geometry for finish to rough machining, and continuous to interrupted cuts.	T9415	-	100	1.00	3.5	-	-	-	95	1.00	3.5	-	-	-	-	-	-	-	-
  RM2 geometry for semi-rough to rough machining, and continuous to interrupted cuts.	T9415	-	95	1.10	3.5	-	-	-	90	1.10	3.5	-	-	-	-	-	-	-	-
  RM2 geometry for semi-rough to rough machining, and continuous to interrupted cuts.	T9415	-	95	1.00	4.5	-	-	-	90	1.00	4.5	-	-	-	-	-	-	-	-
 RR2 geometry for heavy rough machining, and continuous to interrupted cuts.	T9415	-	70	1.40	4.5	-	-	-	65	1.40	4.5	-	-	-	-	-	10	0.70	2.0



RNMG

PRAMET

	INSD (mm)	D1 (mm)	S (mm)
1204	12.700	5.16	4.76
1506	15.875	6.35	6.35
1906	19.050	7.94	6.35
2509	25.400	9.12	9.53

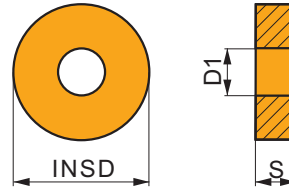

Suitability and starting values for cutting speed (vc), feed (f) and depth of cut (ap). Refer to our Machining Calculator app for further calculations.

Product	RE (mm)	P			M			K			N			S			H		
		vc (m/min)	f (mm/rev)	ap (mm)	vc (m/min)	f (mm/rev)	ap (mm)	vc (m/min)	f (mm/rev)	ap (mm)	vc (m/min)	f (mm/rev)	ap (mm)	vc (m/min)	f (mm/rev)	ap (mm)	vc (m/min)	f (mm/rev)	ap (mm)

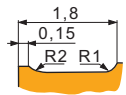
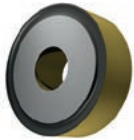

Geometry 08 for semi-rough to heavy-rough machining, and continuous to interrupted cuts.

RNMG 120400E-08	T9415	-	190	0.70	3.0	-	-	-	180	0.70	3.0	-	-	-	-	-	-	35	0.35	0.8
RNMG 150600E-08	T9415	-	190	0.70	3.0	-	-	-	180	0.70	3.0	-	-	-	-	-	-	35	0.35	1.0
RNMG 190600E-08	T9415	-	190	0.70	3.0	-	-	-	180	0.70	3.0	-	-	-	-	-	-	35	0.35	1.3

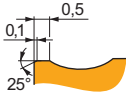
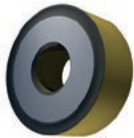

Geometry 081 for rough to heavy-rough machining, and continuous to interrupted cuts.

RNMG 250900E-081	T9415	-	100	0.90	5.0	-	-	-	95	0.90	5.0	-	-	-	-	-	-	20	0.45	1.7
------------------	-------	---	-----	------	-----	---	---	---	----	------	-----	---	---	---	---	---	---	----	------	-----

SCMT

PRAMET

	IC (mm)	D1 (mm)	L (mm)	S (mm)
09T3	9.525	4.40	9.53	3.97
1204	12.700	5.50	12.70	4.76

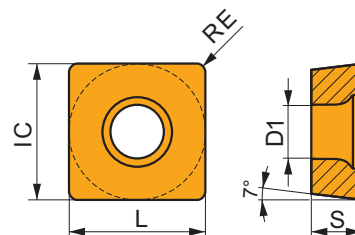

Suitability and starting values for cutting speed (vc), feed (f) and depth of cut (ap). Refer to our Machining Calculator app for further calculations.

Product	RE (mm)	P			M			K			N			S			H		
		vc (m/min)	f (mm/rev)	ap (mm)	vc (m/min)	f (mm/rev)	ap (mm)	vc (m/min)	f (mm/rev)	ap (mm)	vc (m/min)	f (mm/rev)	ap (mm)	vc (m/min)	f (mm/rev)	ap (mm)	vc (m/min)	f (mm/rev)	ap (mm)

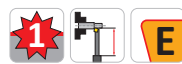
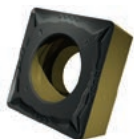







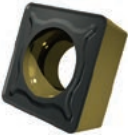
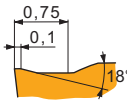

FM geometry for finish to semi-rough machining, and continuous to slightly interrupted cuts.

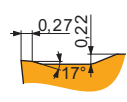
SCMT 09T304E-FM	T9415	0.4	320	0.15	1.2	-	-	-	300	0.15	1.2	-	-	-	-	-	-	-	-	-
SCMT 09T308E-FM	T9415	0.8	350	0.20	1.2	-	-	-	330	0.20	1.2	-	-	-	-	-	-	-	-	-
SCMT 120404E-FM	T9415	0.4	315	0.15	1.6	-	-	-	295	0.15	1.6	-	-	-	-	-	-	-	-	-
SCMT 120408E-FM	T9415	0.8	340	0.20	1.6	-	-	-	320	0.20	1.6	-	-	-	-	-	-	-	-	-
SCMT 120412E-FM	T9415	1.2	320	0.27	1.6	-	-	-	300	0.27	1.6	-	-	-	-	-	-	-	-	-

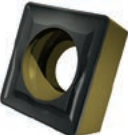
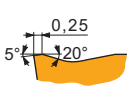

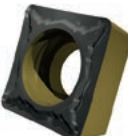
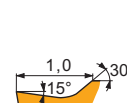
Suitability and starting values for cutting speed (vc), feed (f) and depth of cut (ap). Refer to our Machining Calculator app for further calculations.

Product	RE (mm)	P			M			K			N			S			H		
		vc (m/min)	f (mm/rev)	ap (mm)	vc (m/min)	f (mm/rev)	ap (mm)	vc (m/min)	f (mm/rev)	ap (mm)	vc (m/min)	f (mm/rev)	ap (mm)	vc (m/min)	f (mm/rev)	ap (mm)	vc (m/min)	f (mm/rev)	ap (mm)
  																			
SCMT 09T308E-FM2	T9415 0.8	340	0.17	1.0	–	–	–	320	0.17	1.0	–	–	–	–	–	–	–	–	–
  																			
SCMT 09T308E-RM	T9415 0.8	295	0.30	2.0	–	–	–	280	0.30	2.0	–	–	–	–	–	–	55	0.15	0.7
SCMT 120408E-RM	T9415 0.8	295	0.30	2.3	–	–	–	280	0.30	2.3	–	–	–	–	–	–	55	0.15	0.7
  																			
SCMT 120408E-RM3	T9415 0.8	265	0.27	2.3	–	–	–	250	0.27	2.3	–	–	–	–	–	–	50	0.14	0.7
  																			
SCMT 09T304E-UR	T9415 0.4	280	0.15	1.2	–	–	–	265	0.15	1.2	–	–	–	–	–	–	–	–	–
SCMT 09T308E-UR	T9415 0.8	300	0.20	1.2	–	–	–	285	0.20	1.2	–	–	–	–	–	–	–	–	–





SNMG

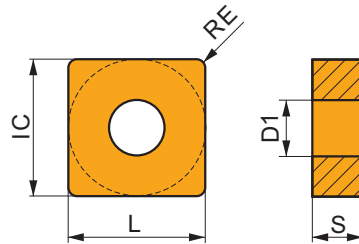

	IC (mm)	D1 (mm)	L (mm)	S (mm)
1204	12.700	5.16	12.70	4.76
1506	15.875	6.35	15.88	6.35
1906	19.050	7.94	19.05	6.35
2509	25.400	9.12	25.40	9.53

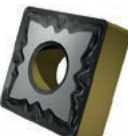
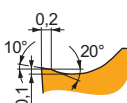

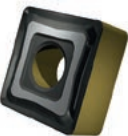
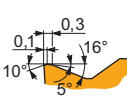
Suitability and starting values for cutting speed (vc), feed (f) and depth of cut (ap). Refer to our Machining Calculator app for further calculations.

Product	RE (mm)	P			M			K			N			S			H		
		vc (m/min)	f (mm/rev)	ap (mm)	vc (m/min)	f (mm/rev)	ap (mm)	vc (m/min)	f (mm/rev)	ap (mm)	vc (m/min)	f (mm/rev)	ap (mm)	vc (m/min)	f (mm/rev)	ap (mm)	vc (m/min)	f (mm/rev)	ap (mm)
  																			
SNMG 120404E-FM	T9415 0.4	305	0.20	2.1	–	–	–	285	0.20	2.1	–	–	–	–	–	–	–	–	–
SNMG 120408E-FM	T9415 0.8	365	0.20	2.1	–	–	–	345	0.20	2.1	–	–	–	–	–	–	–	–	–
SNMG 120412E-FM	T9415 1.2	345	0.27	2.1	–	–	–	325	0.27	2.1	–	–	–	–	–	–	–	–	–
  																			
SNMG 120408E-M	T9415 0.8	280	0.32	2.1	–	–	–	265	0.32	2.1	–	–	–	–	–	–	55	0.16	0.7
SNMG 120412E-M	T9415 1.2	275	0.40	2.1	–	–	–	260	0.40	2.1	–	–	–	–	–	–	55	0.20	1.0



Suitability and starting values for cutting speed (vc), feed (f) and depth of cut (ap). Refer to our Machining Calculator app for further calculations.

Product	RE (mm)	P			M			K			N			S			H		
		vc (m/min)	f (mm/rev)	ap (mm)	vc (m/min)	f (mm/rev)	ap (mm)	vc (m/min)	f (mm/rev)	ap (mm)	vc (m/min)	f (mm/rev)	ap (mm)	vc (m/min)	f (mm/rev)	ap (mm)	vc (m/min)	f (mm/rev)	ap (mm)

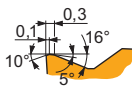
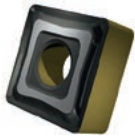

M geometry for finish to semi-rough machining, and continuous to interrupted cuts.

SNMG 150612E-M	T9415	1.2	260	0.40	3.4	—	—	—	245	0.40	3.4	—	—	—	—	—	—	50	0.20	1.0
SNMG 190612E-M	T9415	1.2	255	0.40	4.0	—	—	—	240	0.40	4.0	—	—	—	—	—	—	50	0.20	1.0
SNMG 190616E-M	T9415	1.6	270	0.40	4.0	—	—	—	255	0.40	4.0	—	—	—	—	—	—	50	0.20	1.3

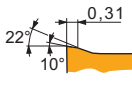

NMR geometry with positive design for medium to rough machining, and continuous cuts.

SNMG 150612E-NMR	T8430	1.2	155	0.40	3.8	85	0.36	3.8	—	—	—	—	—	30	0.28	3.0	—	—	—
SNMG 190616E-NMR	T8430	1.6	150	0.45	5.2	80	0.41	5.2	—	—	—	—	—	30	0.32	4.2	—	—	—
	T9415	1.6	250	0.45	5.2	—	—	—	—	—	—	—	—	—	—	—	—	—	—

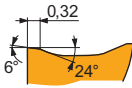
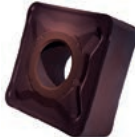

NRM geometry with positive design for semi-rough to rough machining, and continuous to moderate interrupted cuts.

SNMG 120412-NRM	T8430	1.2	165	0.40	3.0	90	0.36	3.0	—	—	—	—	—	35	0.28	2.4	—	—	—
	T9415	1.2	265	0.40	3.0	—	—	—	—	—	—	—	—	—	—	—	—	—	—
SNMG 150616-NRM	T8430	1.6	150	0.45	5.0	80	0.41	5.0	—	—	—	—	—	30	0.32	4.0	—	—	—
	T9415	1.6	250	0.45	5.0	—	—	—	—	—	—	—	—	—	—	—	—	—	—
SNMG 250924-NRM	T9415	2.4	125	0.70	9.0	—	—	—	115	0.70	9.0	—	—	—	—	—	—	—	—

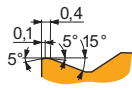
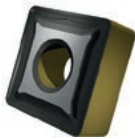

R geometry for semi-rough to rough machining, and continuous to interrupted cuts.

SNMG 120416E-R	T9415	1.6	250	0.50	3.8	—	—	—	235	0.50	3.8	—	—	—	—	—	50	0.25	1.3
SNMG 150612E-R	T9415	1.2	245	0.45	4.5	—	—	—	230	0.45	4.5	—	—	—	—	—	45	0.23	1.0
SNMG 190616E-R	T9415	1.6	240	0.50	6.0	—	—	—	225	0.50	6.0	—	—	—	—	—	45	0.25	1.3

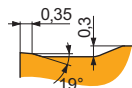
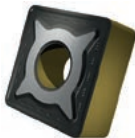

RM geometry for semi-rough to rough machining, and continuous to interrupted cuts.

SNMG 120408E-RM	T9415	0.8	280	0.40	4.0	—	—	—	265	0.40	4.0	—	—	—	—	—	—	—	—
SNMG 120412E-RM	T9415	1.2	280	0.45	4.0	—	—	—	265	0.45	4.0	—	—	—	—	—	—	—	—
SNMG 120416E-RM	T9415	1.6	290	0.50	4.0	—	—	—	275	0.50	4.0	—	—	—	—	—	—	—	—
SNMG 150612E-RM	T9415	1.2	275	0.45	5.0	—	—	—	260	0.45	5.0	—	—	—	—	—	—	—	—
SNMG 150616E-RM	T9415	1.6	285	0.50	5.0	—	—	—	270	0.50	5.0	—	—	—	—	—	—	—	—
SNMG 190612E-RM	T9415	1.2	270	0.45	7.0	—	—	—	255	0.45	7.0	—	—	—	—	—	—	—	—
SNMG 190616E-RM	T8430	1.6	165	0.50	7.0	90	0.45	7.0	135	0.50	7.0	—	—	35	0.35	5.6	—	—	—
	T9415	1.6	270	0.50	7.0	—	—	—	255	0.50	7.0	—	—	—	—	—	—	—	—
SNMG 250924E-RM	T9415	2.4	130	0.80	12.0	—	—	—	120	0.80	12.0	—	—	—	—	—	—	—	—

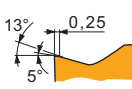
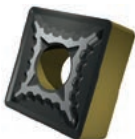

SM geometry with positive design for medium machining and continuous to interrupted cuts.

SNMG 120408E-SM	T9415	0.8	325	0.25	1.8	—	—	—	305	0.25	1.8	—	—	—	—	—	65	0.13	0.7
SNMG 120412E-SM	T9415	1.2	325	0.30	1.8	—	—	—	305	0.30	1.8	—	—	—	—	—	65	0.15	1.0



SNMM

	IC (mm)	D1 (mm)	L (mm)	S (mm)
1204	12.700	5.16	12.70	4.76
1506	15.875	6.35	15.88	6.35
1906	19.050	7.94	19.05	6.35
2507	25.400	9.12	25.40	7.94
2509	25.400	9.12	25.40	9.53

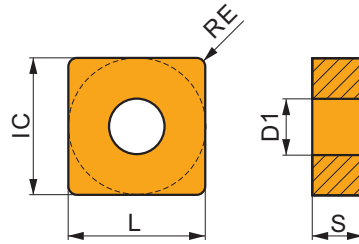

Suitability and starting values for cutting speed (vc), feed (f) and depth of cut (ap). Refer to our Machining Calculator app for further calculations.

Product	RE (mm)	P			M			K			N			S			H		
		vc (m/min)	f (mm/rev)	ap (mm)	vc (m/min)	f (mm/rev)	ap (mm)	vc (m/min)	f (mm/rev)	ap (mm)	vc (m/min)	f (mm/rev)	ap (mm)	vc (m/min)	f (mm/rev)	ap (mm)	vc (m/min)	f (mm/rev)	ap (mm)

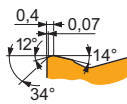
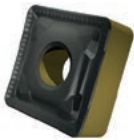

HR geometry for rough to heavy-rough machining, and continuous to interrupted cuts.

SNMM 190624E-HR	T9415	2.4	130	0.65	9.0	–	–	–	120	0.65	9.0	–	–	–	–	–	–	–	–
SNMM 250724E-HR	T9415	2.4	125	0.65	13.0	–	–	–	115	0.65	13.0	–	–	–	–	–	–	–	–
SNMM 250924E-HR	T9415	2.4	125	0.65	13.0	–	–	–	115	0.65	13.0	–	–	–	–	–	–	–	–

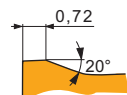
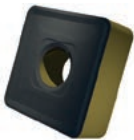

HR2 geometry for rough to heavy-rough machining, and continuous to interrupted cuts.

SNMM 190616-HR2	T9415	1.6	125	0.65	8.9	–	–	–	115	0.65	8.9	–	–	–	–	–	–	–	–
SNMM 190624-HR2	T9415	2.4	120	0.85	8.9	–	–	–	110	0.85	8.9	–	–	–	–	–	–	–	–
SNMM 250924-HR2	T9415	2.4	115	0.85	11.0	–	–	–	105	0.85	11.0	–	–	–	–	–	–	–	–

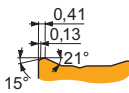
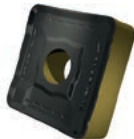

NR2 geometry for semi-rough to rough machining, and continuous to interrupted cuts.

SNMM 190616E-NR2	T9415	1.6	260	0.50	8.0	–	–	–	245	0.50	8.0	–	–	–	–	–	–	–	–
SNMM 250724E-NR2	T9415	2.4	125	0.80	12.0	–	–	–	115	0.80	12.0	–	–	–	–	–	–	–	–
SNMM 250924E-NR2	T9415	2.4	125	0.80	12.0	–	–	–	115	0.80	12.0	–	–	–	–	–	–	–	–

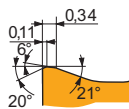
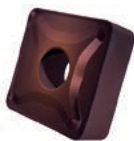

NRM geometry with positive design for semi-rough to rough machining, and continuous to moderate interrupted cuts.

SNMM 250724-NRM	T9415	2.4	130	0.65	9.0	–	–	–	120	0.65	9.0	–	–	–	–	–	–	–	–
SNMM 250924-NRM	T8430	2.4	130	0.70	9.0	70	0.63	9.0	105	0.70	9.0	–	–	–	25	0.49	7.2	–	–

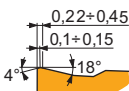
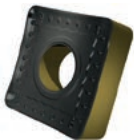

OR geometry for semi-rough to rough machining, and continuous to interrupted cuts.

SNMM 120408E-OR	T9415	0.8	265	0.40	4.7	–	–	–	250	0.40	4.7	–	–	–	–	–	–	–	–
SNMM 120412E-OR	T9415	1.2	270	0.45	4.7	–	–	–	255	0.45	4.7	–	–	–	–	–	–	–	–
SNMM 150616E-OR	T9415	1.6	265	0.50	6.0	–	–	–	250	0.50	6.0	–	–	–	–	–	–	–	–
SNMM 190612E-OR	T9415	1.2	250	0.45	8.0	–	–	–	235	0.45	8.0	–	–	–	–	–	–	–	–
SNMM 190616E-OR	T9415	1.6	260	0.50	8.0	–	–	–	245	0.50	8.0	–	–	–	–	–	–	–	–
SNMM 190624E-OR	T9415	2.4	225	0.80	8.0	–	–	–	210	0.80	8.0	–	–	–	–	–	–	–	–
SNMM 250724E-OR	T9415	2.4	120	1.00	12.0	–	–	–	110	1.00	12.0	–	–	–	–	–	–	–	–
SNMM 250924E-OR	T9415	2.4	120	1.00	12.0	–	–	–	110	1.00	12.0	–	–	–	–	–	–	–	–



Suitability and starting values for cutting speed (vc), feed (f) and depth of cut (ap). Refer to our Machining Calculator app for further calculations.

Product	RE (mm)	P			M			K			N			S			H		
		vc (m/min)	f (mm/rev)	ap (mm)	vc (m/min)	f (mm/rev)	ap (mm)	vc (m/min)	f (mm/rev)	ap (mm)	vc (m/min)	f (mm/rev)	ap (mm)	vc (m/min)	f (mm/rev)	ap (mm)	vc (m/min)	f (mm/rev)	ap (mm)

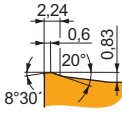
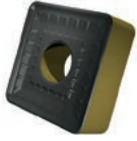

Geometry 923 for semi-rough to heavy-rough machining, and continuous to heavy interrupted cuts.

SNMM 250924S-923	T9415	2.4	115	0.85	11.0	-	-	-	105	0.85	11.0	-	-	-	-	-	-	-	-
------------------	-------	-----	-----	------	------	---	---	---	-----	------	------	---	---	---	---	---	---	---	---

TCMT



	IC (mm)	D1 (mm)	L (mm)	S (mm)
06T1	3.970	2.20	6.90	1.98
0902	5.560	2.50	9.60	2.38
1102	6.350	2.80	11.00	2.38
16T3	9.525	4.40	16.50	3.97

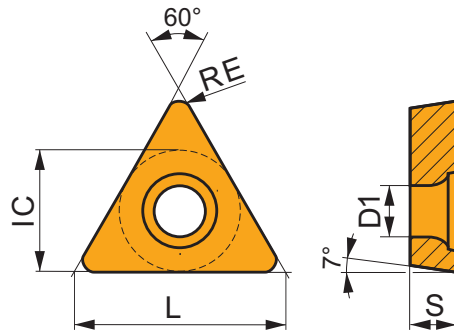

Suitability and starting values for cutting speed (vc), feed (f) and depth of cut (ap). Refer to our Machining Calculator app for further calculations.

Product	RE (mm)	P			M			K			N			S			H		
		vc (m/min)	f (mm/rev)	ap (mm)	vc (m/min)	f (mm/rev)	ap (mm)	vc (m/min)	f (mm/rev)	ap (mm)	vc (m/min)	f (mm/rev)	ap (mm)	vc (m/min)	f (mm/rev)	ap (mm)	vc (m/min)	f (mm/rev)	ap (mm)

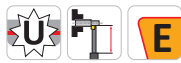
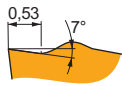

FF2 geometry with positive design for fine-finish to finish machining, and continuous to slightly interrupted cuts.

TCMT 06T102E-FF2	T9415	0.2	335	0.05	0.8	-	-	-	315	0.05	0.8	-	-	-	-	-	-	-
TCMT 06T104E-FF2	T9415	0.4	265	0.12	0.8	-	-	-	250	0.12	0.8	-	-	-	-	-	-	-
TCMT 090204E-FF2	T9415	0.4	260	0.12	1.0	-	-	-	245	0.12	1.0	-	-	-	-	-	-	-
TCMT 110204E-FF2	T9415	0.4	265	0.12	0.8	-	-	-	250	0.12	0.8	-	-	-	-	-	-	-
TCMT 110208E-FF2	T9415	0.8	280	0.17	0.8	-	-	-	265	0.17	0.8	-	-	-	-	-	-	-
TCMT 16T304E-FF2	T9415	0.4	265	0.12	0.8	-	-	-	250	0.12	0.8	-	-	-	-	-	-	-
TCMT 16T308E-FF2	T9415	0.8	280	0.17	0.8	-	-	-	265	0.17	0.8	-	-	-	-	-	-	-

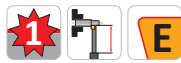

FM geometry for finish to semi-rough machining, and continuous to slightly interrupted cuts.

TCMT 110202E-FM	T9415	0.2	290	0.10	0.8	-	-	-	275	0.10	0.8	-	-	-	-	-	-	-
TCMT 110204E-FM	T9415	0.4	295	0.12	0.8	-	-	-	280	0.12	0.8	-	-	-	-	-	-	-
TCMT 110208E-FM	T9415	0.8	310	0.17	0.8	-	-	-	290	0.17	0.8	-	-	-	-	-	-	-
TCMT 16T304E-FM	T9415	0.4	270	0.12	1.7	-	-	-	255	0.12	1.7	-	-	-	-	-	-	-
TCMT 16T308E-FM	T9415	0.8	285	0.17	1.7	-	-	-	270	0.17	1.7	-	-	-	-	-	-	-

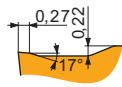
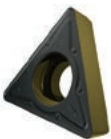

RM geometry for semi-rough to rough machining, and continuous to interrupted cuts.

TCMT 16T308E-RM	T9415	0.8	250	0.27	1.9	-	-	-	235	0.27	1.9	-	-	-	-	-	50	0.14	0.7
TCMT 16T312E-RM	T9415	1.2	265	0.27	1.9	-	-	-	250	0.27	1.9	-	-	-	-	-	50	0.14	0.9

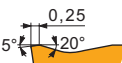

RM3 geometry for semi-rough to rough machining, and continuous to interrupted cuts.

TCMT 16T304E-RM3	T9415	0.4	205	0.20	2.0	-	-	-	190	0.20	2.0	-	-	-	-	-	40	0.14	0.3
------------------	-------	-----	-----	------	-----	---	---	---	-----	------	-----	---	---	---	---	---	----	------	-----



Suitability and starting values for cutting speed (vc), feed (f) and depth of cut (ap). Refer to our Machining Calculator app for further calculations.

Product	RE (mm)	P			M			K			N			S			H		
		vc (m/min)	f (mm/rev)	ap (mm)	vc (m/min)	f (mm/rev)	ap (mm)	vc (m/min)	f (mm/rev)	ap (mm)	vc (m/min)	f (mm/rev)	ap (mm)	vc (m/min)	f (mm/rev)	ap (mm)	vc (m/min)	f (mm/rev)	ap (mm)

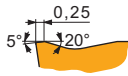

RM3 geometry for semi-rough to rough machining, and continuous to interrupted cuts.

TCMT 16T308E-RM3	T9415	0.8	220	0.27	2.0	-	-	-	205	0.27	2.0	-	-	-	-	-	-	40	0.14	0.7
------------------	-------	-----	-----	------	-----	---	---	---	-----	------	-----	---	---	---	---	---	---	----	------	-----

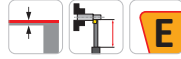
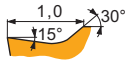

UR geometry for fine to finish machining, and continuous to slightly interrupted cuts.

TCMT 110204E-UR	T9415	0.4	255	0.12	0.8	-	-	-	240	0.12	0.8	-	-	-	-	-	-	-	-	-
TCMT 16T304E-UR	T9415	0.4	255	0.12	0.8	-	-	-	240	0.12	0.8	-	-	-	-	-	-	-	-	-
TCMT 16T308E-UR	T9415	0.8	265	0.17	0.8	-	-	-	250	0.17	0.8	-	-	-	-	-	-	-	-	-

TNMG



	IC (mm)	D1 (mm)	L (mm)	S (mm)
1604	9.525	3.81	16.50	4.76
2204	12.700	5.16	22.00	4.76
2706	15.875	6.35	27.50	6.35

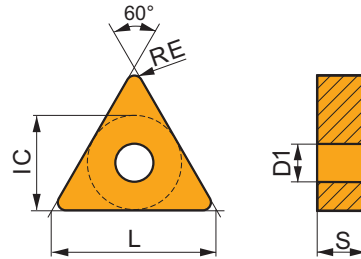

Suitability and starting values for cutting speed (vc), feed (f) and depth of cut (ap). Refer to our Machining Calculator app for further calculations.

Product	RE (mm)	P			M			K			N			S			H		
		vc (m/min)	f (mm/rev)	ap (mm)	vc (m/min)	f (mm/rev)	ap (mm)	vc (m/min)	f (mm/rev)	ap (mm)	vc (m/min)	f (mm/rev)	ap (mm)	vc (m/min)	f (mm/rev)	ap (mm)	vc (m/min)	f (mm/rev)	ap (mm)

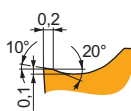
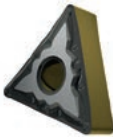

FM geometry with positive design for finish to semi-rough machining, and continuous to slightly interrupted cuts.

TNMG 160404E-FM	T9415	0.4	250	0.20	1.7	-	-	-	235	0.20	1.7	-	-	-	-	-	-	-	-	-
TNMG 160408E-FM	T9415	0.8	300	0.20	1.7	-	-	-	285	0.20	1.7	-	-	-	-	-	-	-	-	-
TNMG 160412E-FM	T9415	1.2	290	0.25	1.7	-	-	-	275	0.25	1.7	-	-	-	-	-	-	-	-	-
TNMG 220404E-FM	T9415	0.4	250	0.20	1.7	-	-	-	235	0.20	1.7	-	-	-	-	-	-	-	-	-
TNMG 220408E-FM	T9415	0.8	300	0.20	1.7	-	-	-	285	0.20	1.7	-	-	-	-	-	-	-	-	-

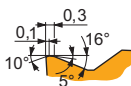
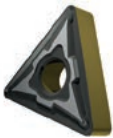

M geometry for finish to semi-rough machining, and continuous to interrupted cuts.

TNMG 160404E-M	T9415	0.4	230	0.20	1.6	-	-	-	215	0.20	1.6	-	-	-	-	-	-	45	0.14	0.3
TNMG 160408E-M	T9415	0.8	240	0.30	1.6	-	-	-	225	0.30	1.6	-	-	-	-	-	-	45	0.15	0.7
TNMG 160412E-M	T9415	1.2	225	0.40	1.6	-	-	-	210	0.40	1.6	-	-	-	-	-	-	45	0.20	0.9
TNMG 220408E-M	T9415	0.8	230	0.30	2.1	-	-	-	215	0.30	2.1	-	-	-	-	-	-	45	0.15	0.7
TNMG 220412E-M	T9415	1.2	225	0.40	2.1	-	-	-	210	0.40	2.1	-	-	-	-	-	-	45	0.20	0.9

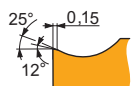
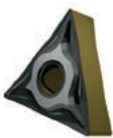

NF geometry with highly positive design for fine-finish to medium machining, and continuous cuts.

TNMG 160404E-NF	T9415	0.4	285	0.15	1.4	-	-	-	270	0.15	1.4	-	-	-	-	-	-	-	-	-
-----------------	-------	-----	-----	------	-----	---	---	---	-----	------	-----	---	---	---	---	---	---	---	---	---



Suitability and starting values for cutting speed (vc), feed (f) and depth of cut (ap). Refer to our Machining Calculator app for further calculations.

Product	RE (mm)	P			M			K			N			S			H		
		vc (m/min)	f (mm/rev)	ap (mm)	vc (m/min)	f (mm/rev)	ap (mm)	vc (m/min)	f (mm/rev)	ap (mm)	vc (m/min)	f (mm/rev)	ap (mm)	vc (m/min)	f (mm/rev)	ap (mm)	vc (m/min)	f (mm/rev)	ap (mm)

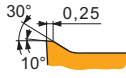
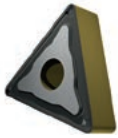

NM geometry with highly positive design for fine-finish, medium and rough machining, in continuous cuts.

TNMG 160408E-NM	T9415	0.8	290	0.25	1.9	-	-	-	-	-	-	-	-	-	-	-	-	-
-----------------	-------	-----	-----	------	-----	---	---	---	---	---	---	---	---	---	---	---	---	---

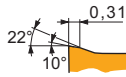

NMR geometry with positive design for medium to rough machining, and continuous cuts.

TNMG 160408E-NMR	T9415	0.8	235	0.30	1.7	-	-	-	-	-	-	-	-	-	-	-	-	-
TNMG 160412E-NMR	T8430	1.2	155	0.30	1.7	85	0.27	1.7	-	-	-	-	30	0.24	1.4	-	-	-
	T9415	1.2	250	0.30	1.7	-	-	-	-	-	-	-	-	-	-	-	-	-
TNMG 220412E-NMR	T9415	1.2	245	0.30	2.1	-	-	-	-	-	-	-	-	-	-	-	-	-

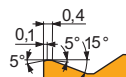
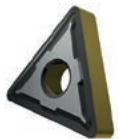

R geometry for semi-rough to rough machining, and continuous to interrupted cuts.

TNMG 160408E-R	T9415	0.8	205	0.40	3.0	-	-	-	190	0.40	3.0	-	-	-	-	40	0.20	0.7
TNMG 160412E-R	T9415	1.2	215	0.40	3.0	-	-	-	200	0.40	3.0	-	-	-	-	40	0.20	0.9
TNMG 220408E-R	T9415	0.8	195	0.40	4.0	-	-	-	185	0.40	4.0	-	-	-	-	35	0.20	0.7
TNMG 220412E-R	T9415	1.2	205	0.40	4.0	-	-	-	190	0.40	4.0	-	-	-	-	40	0.20	0.9

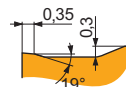
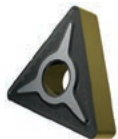

RM geometry for semi-rough to rough machining, and continuous to interrupted cuts.

TNMG 160408E-RM	T9415	0.8	235	0.40	3.0	-	-	-	220	0.40	3.0	-	-	-	-	-	-	-
TNMG 160412E-RM	T9415	1.2	245	0.40	3.0	-	-	-	230	0.40	3.0	-	-	-	-	-	-	-
TNMG 220408E-RM	T9415	0.8	225	0.40	4.0	-	-	-	210	0.40	4.0	-	-	-	-	-	-	-
TNMG 220412E-RM	T9415	1.2	235	0.40	4.0	-	-	-	220	0.40	4.0	-	-	-	-	-	-	-
TNMG 220416E-RM	T9415	1.6	250	0.40	4.0	-	-	-	235	0.40	4.0	-	-	-	-	-	-	-
TNMG 270616E-RM	T9415	1.6	140	0.40	6.0	-	-	-	130	0.40	6.0	-	-	-	-	-	-	-

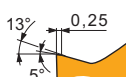
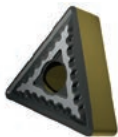

SM geometry with positive design for medium machining, and continuous to interrupted cuts.

TNMG 160404E-SM	T9415	0.4	240	0.20	1.7	-	-	-	225	0.20	1.7	-	-	-	-	45	0.14	0.3
TNMG 160408E-SM	T9415	0.8	265	0.25	1.7	-	-	-	250	0.25	1.7	-	-	-	-	50	0.13	0.7
TNMG 220408E-SM	T9415	0.8	265	0.25	1.7	-	-	-	250	0.25	1.7	-	-	-	-	50	0.13	0.7
TNMG 220412E-SM	T9415	1.2	260	0.30	1.7	-	-	-	245	0.30	1.7	-	-	-	-	50	0.15	0.9



TNMM

	IC (mm)	D1 (mm)	L (mm)	S (mm)
1604	9.525	3.81	16.50	4.76

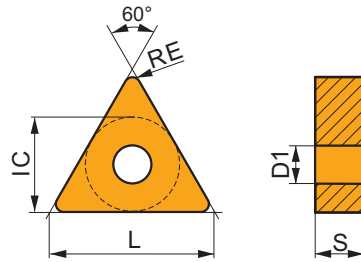

Suitability and starting values for cutting speed (vc), feed (f) and depth of cut (ap). Refer to our Machining Calculator app for further calculations.

Product	RE (mm)	P			M			K			N			S			H		
		vc (m/min)	f (mm/rev)	ap (mm)	vc (m/min)	f (mm/rev)	ap (mm)	vc (m/min)	f (mm/rev)	ap (mm)	vc (m/min)	f (mm/rev)	ap (mm)	vc (m/min)	f (mm/rev)	ap (mm)	vc (m/min)	f (mm/rev)	ap (mm)

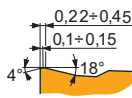
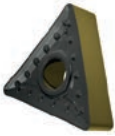

OR geometry for semi-rough to rough machining, and continuous to interrupted cuts.

TNMM 160408E-OR	T9415	0.8	225	0.40	3.0	—	—	—	210	0.40	3.0	—	—	—	—	—	—	—
-----------------	-------	-----	-----	------	-----	---	---	---	-----	------	-----	---	---	---	---	---	---	---

VBMT

	IC (mm)	D1 (mm)	L (mm)	S (mm)
1103	6.350	2.80	11.10	3.18
1604	9.525	4.40	16.60	4.76

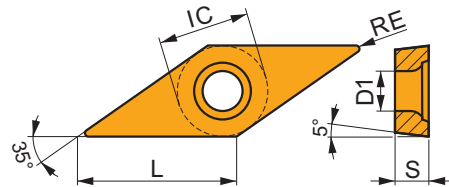

Suitability and starting values for cutting speed (vc), feed (f) and depth of cut (ap). Refer to our Machining Calculator app for further calculations.

Product	RE (mm)	P			M			K			N			S			H		
		vc (m/min)	f (mm/rev)	ap (mm)	vc (m/min)	f (mm/rev)	ap (mm)	vc (m/min)	f (mm/rev)	ap (mm)	vc (m/min)	f (mm/rev)	ap (mm)	vc (m/min)	f (mm/rev)	ap (mm)	vc (m/min)	f (mm/rev)	ap (mm)

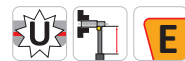
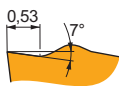

FF2 geometry with positive design for fine-finish to finish machining, and continuous to slightly interrupted cuts.

VBMT 160404E-FF2	T9415	0.4	230	0.12	0.8	—	—	—	215	0.12	0.8	—	—	—	—	—	—	—
------------------	-------	-----	-----	------	-----	---	---	---	-----	------	-----	---	---	---	---	---	---	---

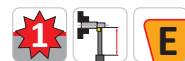

FM geometry for finish to semi-rough machining, and continuous to slightly interrupted cuts.

VBMT 110304E-FM	T9415	0.4	255	0.12	0.8	—	—	—	240	0.12	0.8	—	—	—	—	—	—	—
VBMT 110308E-FM	T9415	0.8	270	0.17	0.8	—	—	—	255	0.17	0.8	—	—	—	—	—	—	—
VBMT 160402E-FM	T9415	0.2	245	0.10	1.2	—	—	—	230	0.10	1.2	—	—	—	—	—	—	—
VBMT 160404E-FM	T9415	0.4	245	0.12	1.2	—	—	—	230	0.12	1.2	—	—	—	—	—	—	—
VBMT 160408E-FM	T9415	0.8	260	0.17	1.2	—	—	—	245	0.17	1.2	—	—	—	—	—	—	—
VBMT 160412E-FM	T9415	1.2	245	0.22	1.2	—	—	—	230	0.22	1.2	—	—	—	—	—	—	—



Suitability and starting values for cutting speed (vc), feed (f) and depth of cut (ap). Refer to our Machining Calculator app for further calculations.

Product	RE (mm)	P			M			K			N			S			H		
		vc (m/min)	f (mm/rev)	ap (mm)	vc (m/min)	f (mm/rev)	ap (mm)	vc (m/min)	f (mm/rev)	ap (mm)	vc (m/min)	f (mm/rev)	ap (mm)	vc (m/min)	f (mm/rev)	ap (mm)	vc (m/min)	f (mm/rev)	ap (mm)

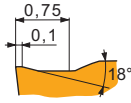

FM2 geometry for finish to medium machining, and continuous to interrupted cuts.

VBMT 160404E-FM2	T9415	0.4	220	0.12	1.2	–	–	–	205	0.12	1.2	–	–	–	–	–	–	–
VBMT 160408E-FM2	T9415	0.8	220	0.20	1.2	–	–	–	205	0.20	1.2	–	–	–	–	–	–	–
VBMT 160412E-FM2	T9415	1.2	225	0.22	1.2	–	–	–	210	0.22	1.2	–	–	–	–	–	–	–

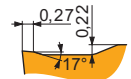

RM geometry for semi-rough to rough machining, and continuous to interrupted cuts.

VBMT 160404E-RM	T9415	0.4	255	0.12	1.2	–	–	–	240	0.12	1.2	–	–	–	–	–	50	0.12	0.3
VBMT 160408E-RM	T9415	0.8	270	0.17	1.2	–	–	–	255	0.17	1.2	–	–	–	–	–	50	0.12	0.7
VBMT 160412E-RM	T9415	1.2	240	0.27	1.2	–	–	–	225	0.27	1.2	–	–	–	–	–	45	0.14	0.9

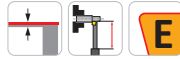
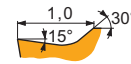

UR geometry for fine to finish machining, and continuous to slightly interrupted cuts.

VBMT 160404E-UR	T9415	0.4	210	0.12	1.2	–	–	–	195	0.12	1.2	–	–	–	–	–	–	–
VBMT 160408E-UR	T9415	0.8	225	0.17	1.2	–	–	–	210	0.17	1.2	–	–	–	–	–	–	–
VBMT 160412E-UR	T9415	1.2	210	0.22	1.2	–	–	–	195	0.22	1.2	–	–	–	–	–	–	–

VCGT

PRAMET

	IC (mm)	D1 (mm)	L (mm)	S (mm)
1303	7.940	3.40	13.80	3.18

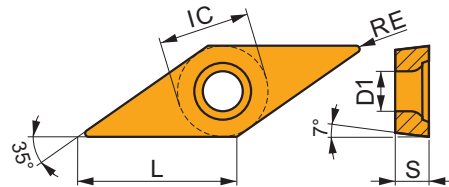

Suitability and starting values for cutting speed (vc), feed (f) and depth of cut (ap). Refer to our Machining Calculator app for further calculations.

Product	RE (mm)	P			M			K			N			S			H		
		vc (m/min)	f (mm/rev)	ap (mm)	vc (m/min)	f (mm/rev)	ap (mm)	vc (m/min)	f (mm/rev)	ap (mm)	vc (m/min)	f (mm/rev)	ap (mm)	vc (m/min)	f (mm/rev)	ap (mm)	vc (m/min)	f (mm/rev)	ap (mm)

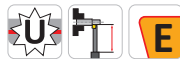
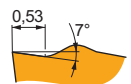

FF2 geometry with positive design for fine-finish to finish machining, and continuous to slightly interrupted cuts.

VCGT 130302E-FF2	T9415	0.2	270	0.05	1.0	–	–	–	255	0.05	1.0	–	–	–	–	–	–	–
VCGT 130304E-FF2	T9415	0.4	215	0.12	1.0	–	–	–	200	0.12	1.0	–	–	–	–	–	–	–
VCGT 130308E-FF2	T9415	0.8	225	0.17	1.0	–	–	–	210	0.17	1.0	–	–	–	–	–	–	–



NF2 geometry with positive design for fine-finish to semi-rough machining, and continuous cuts.

VCGT 130304E-NF2	T9415	0.4	225	0.10	1.0	–	–	–	210	0.10	1.0	–	–	–	–	–	–	–
VCGT 130308E-NF2	T9415	0.8	225	0.17	1.0	–	–	–	210	0.17	1.0	–	–	–	–	–	–	–



VCMT

	IC (mm)	D1 (mm)	L (mm)	S (mm)
1103	6.350	2.80	11.10	3.18
1604	9.525	4.40	16.60	4.76

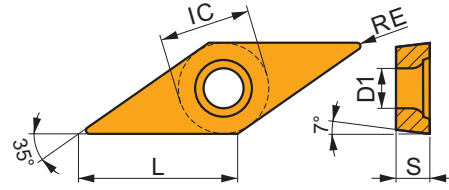

Suitability and starting values for cutting speed (vc), feed (f) and depth of cut (ap). Refer to our Machining Calculator app for further calculations.

Product	RE (mm)	P			M			K			N			S			H		
		vc (m/min)	f (mm/rev)	ap (mm)	vc (m/min)	f (mm/rev)	ap (mm)	vc (m/min)	f (mm/rev)	ap (mm)	vc (m/min)	f (mm/rev)	ap (mm)	vc (m/min)	f (mm/rev)	ap (mm)	vc (m/min)	f (mm/rev)	ap (mm)

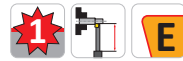
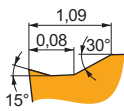

FM geometry for finish to semi-rough machining, and continuous to slightly interrupted cuts.

VCMT 160404E-FM	T9415	0.4	230	0.12	1.2	–	–	–	215	0.12	1.2	–	–	–	–	–	–	–	–
VCMT 160408E-FM	T9415	0.8	245	0.17	1.2	–	–	–	230	0.17	1.2	–	–	–	–	–	–	–	–

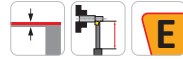
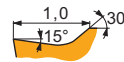

UR geometry for fine to finish machining, and continuous to slightly interrupted cuts.

VCMT 110304E-UR	T9415	0.4	210	0.12	0.8	–	–	–	195	0.12	0.8	–	–	–	–	–	–	–	–
VCMT 110308E-UR	T9415	0.8	220	0.17	0.8	–	–	–	205	0.17	0.8	–	–	–	–	–	–	–	–
VCMT 160404E-UR	T9415	0.4	200	0.12	1.2	–	–	–	190	0.12	1.2	–	–	–	–	–	–	–	–
VCMT 160408E-UR	T9415	0.8	210	0.17	1.2	–	–	–	195	0.17	1.2	–	–	–	–	–	–	–	–

VNMG

	IC (mm)	D1 (mm)	L (mm)	S (mm)
1604	9.525	3.81	16.60	4.76

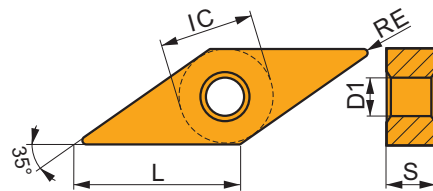

Suitability and starting values for cutting speed (vc), feed (f) and depth of cut (ap). Refer to our Machining Calculator app for further calculations.

Product	RE (mm)	P			M			K			N			S			H		
		vc (m/min)	f (mm/rev)	ap (mm)	vc (m/min)	f (mm/rev)	ap (mm)	vc (m/min)	f (mm/rev)	ap (mm)	vc (m/min)	f (mm/rev)	ap (mm)	vc (m/min)	f (mm/rev)	ap (mm)	vc (m/min)	f (mm/rev)	ap (mm)

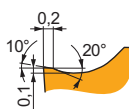

FM geometry with positive design for finish to semi-rough machining and continuous to slightly interrupted cuts.

VNMG 160404E-FM	T9415	0.4	215	0.20	1.2	–	–	–	200	0.20	1.2	–	–	–	–	–	–	–	–
VNMG 160408E-FM	T9415	0.8	255	0.20	1.4	–	–	–	240	0.20	1.4	–	–	–	–	–	–	–	–
VNMG 160412E-FM	T9415	1.2	255	0.22	1.4	–	–	–	240	0.22	1.4	–	–	–	–	–	–	–	–



Suitability and starting values for cutting speed (vc), feed (f) and depth of cut (ap). Refer to our Machining Calculator app for further calculations.

Product	RE (mm)	P			M			K			N			S			H		
		vc (m/min)	f (mm/rev)	ap (mm)	vc (m/min)	f (mm/rev)	ap (mm)	vc (m/min)	f (mm/rev)	ap (mm)	vc (m/min)	f (mm/rev)	ap (mm)	vc (m/min)	f (mm/rev)	ap (mm)	vc (m/min)	f (mm/rev)	ap (mm)

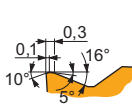

M geometry for finish to semi-rough machining and continuous to interrupted cuts.

VNMG 160404E-M	T9415	0.4	195	0.20	1.2	—	—	—	185	0.20	1.2	—	—	—	—	—	—	35	0.14	0.3
VNMG 160408E-M	T9415	0.8	200	0.30	1.4	—	—	—	190	0.30	1.4	—	—	—	—	—	—	40	0.15	0.7

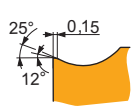

NF geometry with highly positive design for fine-finish to medium machining, and continuous cuts.

VNMG 160404E-NF	T9415	0.4	255	0.12	1.2	—	—	—	240	0.12	1.2	—	—	—	—	—	—	—	—	—
VNMG 160408E-NF	T9415	0.8	270	0.17	1.4	—	—	—	255	0.17	1.4	—	—	—	—	—	—	—	—	—

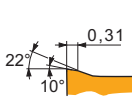

NMR geometry with positive design for medium to rough machining, and continuous cuts.

VNMG 160408E-NMR	T9415	0.8	200	0.30	1.4	—	—	—	—	—	—	—	—	—	—	—	—	—	—	—
------------------	-------	-----	-----	------	-----	---	---	---	---	---	---	---	---	---	---	---	---	---	---	---

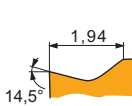

SF geometry with positive design for fine-finish machining and for machining thin walls, with continuous cuts.

VNMG 160408E-SF	T9415	0.8	255	0.17	1.4	—	—	—	240	0.17	1.4	—	—	—	—	—	—	50	0.12	0.7
-----------------	-------	-----	-----	------	-----	---	---	---	-----	------	-----	---	---	---	---	---	---	----	------	-----

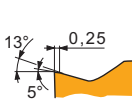

SM geometry with positive design for medium machining, and continuous to interrupted cuts.

VNMG 160404E-SM	T9415	0.4	210	0.18	1.2	—	—	—	195	0.18	1.2	—	—	—	—	—	—	40	0.13	0.3
-----------------	-------	-----	-----	------	-----	---	---	---	-----	------	-----	---	---	---	---	---	---	----	------	-----

WCMT



	IC (mm)	D1 (mm)	L (mm)	S (mm)
06T3	9.525	4.40	6.50	3.97
0804	12.700	5.50	8.70	4.76

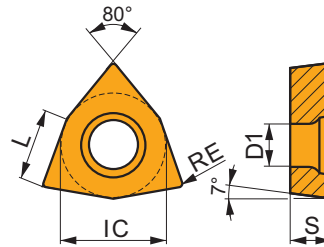

Suitability and starting values for cutting speed (vc), feed (f) and depth of cut (ap). Refer to our Machining Calculator app for further calculations.

Product	RE (mm)	P			M			K			N			S			H		
		vc (m/min)	f (mm/rev)	ap (mm)	vc (m/min)	f (mm/rev)	ap (mm)	vc (m/min)	f (mm/rev)	ap (mm)	vc (m/min)	f (mm/rev)	ap (mm)	vc (m/min)	f (mm/rev)	ap (mm)	vc (m/min)	f (mm/rev)	ap (mm)

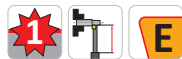
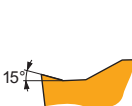
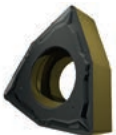

FM geometry for finish to semi-rough machining, and continuous to slightly interrupted cuts.

WCMT 06T304E-FM	T9415	0.4	305	0.15	1.2	—	—	—	285	0.15	1.2	—	—	—	—	—	—	—	—	—
WCMT 06T308E-FM	T9415	0.8	330	0.20	1.2	—	—	—	310	0.20	1.2	—	—	—	—	—	—	—	—	—
WCMT 080408E-FM	T9415	0.8	315	0.20	1.7	—	—	—	295	0.20	1.7	—	—	—	—	—	—	—	—	—



WNMG

	IC	D1	L	S
	(mm)	(mm)	(mm)	(mm)
0604	9.525	3.81	6.50	4.76
0804	12.700	5.16	8.70	4.76

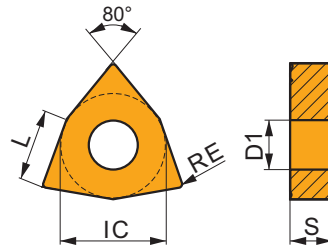

Suitability and starting values for cutting speed (vc), feed (f) and depth of cut (ap). Refer to our Machining Calculator app for further calculations.

Product	RE (mm)	P			M			K			N			S			H		
		vc (m/min)	f (mm/rev)	ap (mm)	vc (m/min)	f (mm/rev)	ap (mm)	vc (m/min)	f (mm/rev)	ap (mm)	vc (m/min)	f (mm/rev)	ap (mm)	vc (m/min)	f (mm/rev)	ap (mm)	vc (m/min)	f (mm/rev)	ap (mm)

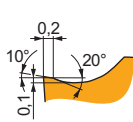
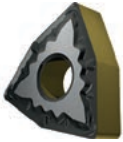

FM geometry with positive design for finish to semi-rough machining, and continuous to slightly interrupted cuts.

WNMG 060404E-FM	T9415	0.4	305	0.20	1.4	–	–	–	285	0.20	1.4	–	–	–	–	–	–	–	–
WNMG 060408E-FM	T9415	0.8	365	0.20	1.4	–	–	–	345	0.20	1.4	–	–	–	–	–	–	–	–
WNMG 060412E-FM	T9415	1.2	350	0.27	1.2	–	–	–	330	0.27	1.2	–	–	–	–	–	–	–	–
WNMG 080404E-FM	T9415	0.4	310	0.20	1.2	–	–	–	290	0.20	1.2	–	–	–	–	–	–	–	–
WNMG 080408E-FM	T9415	0.8	350	0.20	1.9	–	–	–	330	0.20	1.9	–	–	–	–	–	–	–	–
WNMG 080412E-FM	T9415	1.2	335	0.27	1.9	–	–	–	315	0.27	1.9	–	–	–	–	–	–	–	–

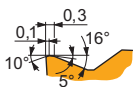
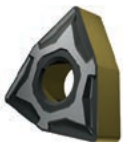

M geometry for finish to semi-rough machining, and continuous to interrupted cuts.

WNMG 060404E-M	T9415	0.4	270	0.20	1.8	–	–	–	255	0.20	1.8	–	–	–	–	–	50	0.13	0.3
WNMG 060408E-M	T9415	0.8	275	0.32	1.8	–	–	–	260	0.32	1.8	–	–	–	–	–	55	0.16	0.7
WNMG 080404E-M	T9415	0.4	265	0.20	2.1	–	–	–	250	0.20	2.1	–	–	–	–	–	50	0.13	0.3
WNMG 080408E-M	T9415	0.8	270	0.32	2.1	–	–	–	255	0.32	2.1	–	–	–	–	–	50	0.16	0.7
WNMG 080412E-M	T9415	1.2	265	0.40	2.1	–	–	–	250	0.40	2.1	–	–	–	–	–	50	0.20	1.0

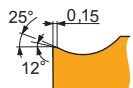
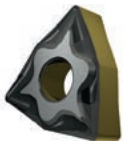

NF geometry with highly positive design for fine-finish to medium machining, and continuous cuts.

WNMG 060404E-NF	T9415	0.4	340	0.17	0.8	–	–	–	320	0.17	0.8	–	–	–	–	–	–	–	–
WNMG 060408E-NF	T9415	0.8	380	0.19	1.0	–	–	–	360	0.19	1.0	–	–	–	–	–	–	–	–
WNMG 080408E-NF	T9415	0.8	360	0.19	1.7	–	–	–	340	0.19	1.7	–	–	–	–	–	–	–	–
WNMG 080412E-NF	T9415	1.2	315	0.30	2.1	–	–	–	295	0.30	2.1	–	–	–	–	–	–	–	–

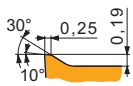
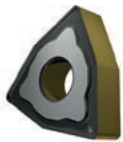

NM geometry with highly positive design for fine-finish, medium and rough machining, with continuous cuts.

WNMG 080404E-NM	T9415	0.4	305	0.20	2.1	–	–	–	–	–	–	–	–	–	–	–	–	–	–
WNMG 080408E-NM	T9415	0.8	335	0.25	2.1	–	–	–	–	–	–	–	–	–	–	–	–	–	–

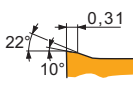









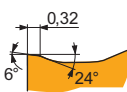

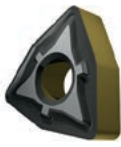
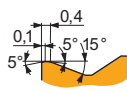

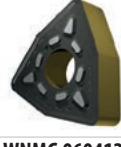
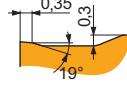

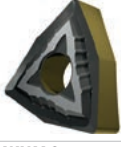
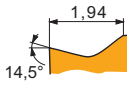
NMR geometry with positive design for medium to rough machining, and continuous cuts.

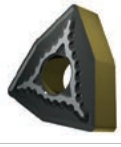
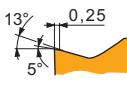
WNMG 060408E-NMR	T8430	0.8	155	0.35	2.7	85	0.32	2.7	–	–	–	–	–	–	30	0.25	2.2	–	–
WNMG 080404E-NMR	T9415	0.4	240	0.25	2.7	–	–	–	–	–	–	–	–	–	–	–	–	–	–
WNMG 080408E-NMR	T9415	0.8	255	0.35	2.7	–	–	–	–	–	–	–	–	–	–	–	–	–	–
WNMG 080412E-NMR	T9415	1.2	255	0.40	2.7	–	–	–	–	–	–	–	–	–	–	–	–	–	–

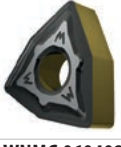
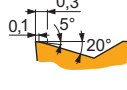

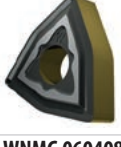
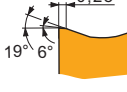
Suitability and starting values for cutting speed (vc), feed (f) and depth of cut (ap). Refer to our Machining Calculator app for further calculations.

Product	RE (mm)	P			M			K			N			S			H			
		vc (m/min)	f (mm/rev)	ap (mm)	vc (m/min)	f (mm/rev)	ap (mm)	vc (m/min)	f (mm/rev)	ap (mm)	vc (m/min)	f (mm/rev)	ap (mm)	vc (m/min)	f (mm/rev)	ap (mm)	vc (m/min)	f (mm/rev)	ap (mm)	
			NRM geometry with positive design for semi-rough to rough machining, and continuous to moderate interrupted cuts.																	
WNMG 080408-NRM	T9415 0.8	255	0.35	2.7	-	-	-	-	-	-	-	-	-	-	-	-	-	-	-	
WNMG 080412-NRM	T8430 1.2	155	0.40	2.7	85	0.36	2.7	-	-	-	-	-	-	30	0.28	2.2	-	-	-	
	T9415 1.2	255	0.40	2.7	-	-	-	-	-	-	-	-	-	-	-	-	-	-	-	
			R geometry for semi-rough to rough machining, and continuous to interrupted cuts.																	
WNMG 080408E-R	T9415 0.8	235	0.40	3.5	-	-	-	220	0.40	3.5	-	-	-	-	-	-	45	0.20	0.7	
WNMG 080412E-R	T9415 1.2	240	0.45	3.5	-	-	-	225	0.45	3.5	-	-	-	-	-	-	45	0.23	1.0	
			RM geometry for semi-rough to rough machining, and continuous to interrupted cuts.																	
WNMG 060412E-RM	T9415 1.2	280	0.45	3.0	-	-	-	265	0.45	3.0	-	-	-	-	-	-	-	-	-	
WNMG 080408E-RM	T9415 0.8	265	0.40	4.0	-	-	-	250	0.40	4.0	-	-	-	-	-	-	-	-	-	
WNMG 080412E-RM	T9415 1.2	270	0.45	4.0	-	-	-	255	0.45	4.0	-	-	-	-	-	-	-	-	-	
WNMG 080416E-RM	T9415 1.6	275	0.50	4.0	-	-	-	260	0.50	4.0	-	-	-	-	-	-	-	-	-	
			SF geometry with positive design for fine-finish machining and for machining thin walls, with continuous cuts.																	
WNMG 080408E-SF	T9415 0.8	355	0.20	1.0	-	-	-	335	0.20	1.0	-	-	-	-	-	-	70	0.13	0.7	
			SM geometry with positive design for medium machining, and continuous to interrupted cuts.																	
WNMG 080404E-SM	T9415 0.4	280	0.20	2.0	-	-	-	265	0.20	2.0	-	-	-	-	-	-	55	0.13	0.3	
WNMG 080408E-SM	T9415 0.8	305	0.25	2.0	-	-	-	285	0.25	2.0	-	-	-	-	-	-	60	0.13	0.7	
WNMG 080412E-SM	T9415 1.2	300	0.30	2.0	-	-	-	285	0.30	2.0	-	-	-	-	-	-	60	0.15	1.0	
			W-M wiper geometry for semi-rough to rough machining with increased feed rates and improved surface finish.																	
WNMG 060408W-M	T9415 0.8	255	0.45	1.2	-	-	-	240	0.45	1.2	-	-	-	-	-	-	-	-	-	
WNMG 060412W-M	T9415 1.2	250	0.55	1.2	-	-	-	235	0.55	1.2	-	-	-	-	-	-	-	-	-	
WNMG 080408W-M	T9415 0.8	245	0.45	1.5	-	-	-	230	0.45	1.5	-	-	-	-	-	-	-	-	-	
			W-MR wiper geometry for finish to rough machining with increased feed rates and improved surface finish.																	
WNMG 060408W-MR	T9415 0.8	255	0.45	1.2	-	-	-	240	0.45	1.2	-	-	-	-	-	-	-	-	-	
WNMG 080404W-MR	T9415 0.4	240	0.30	1.5	-	-	-	225	0.30	1.5	-	-	-	-	-	-	-	-	-	
WNMG 080408W-MR	T9415 0.8	245	0.45	1.5	-	-	-	230	0.45	1.5	-	-	-	-	-	-	-	-	-	
WNMG 080412W-MR	T9415 1.2	245	0.55	1.5	-	-	-	230	0.55	1.5	-	-	-	-	-	-	-	-	-	



DORMER PRAMET



HAVE YOU TRIED OUR NEW LOOK E-SHOP?

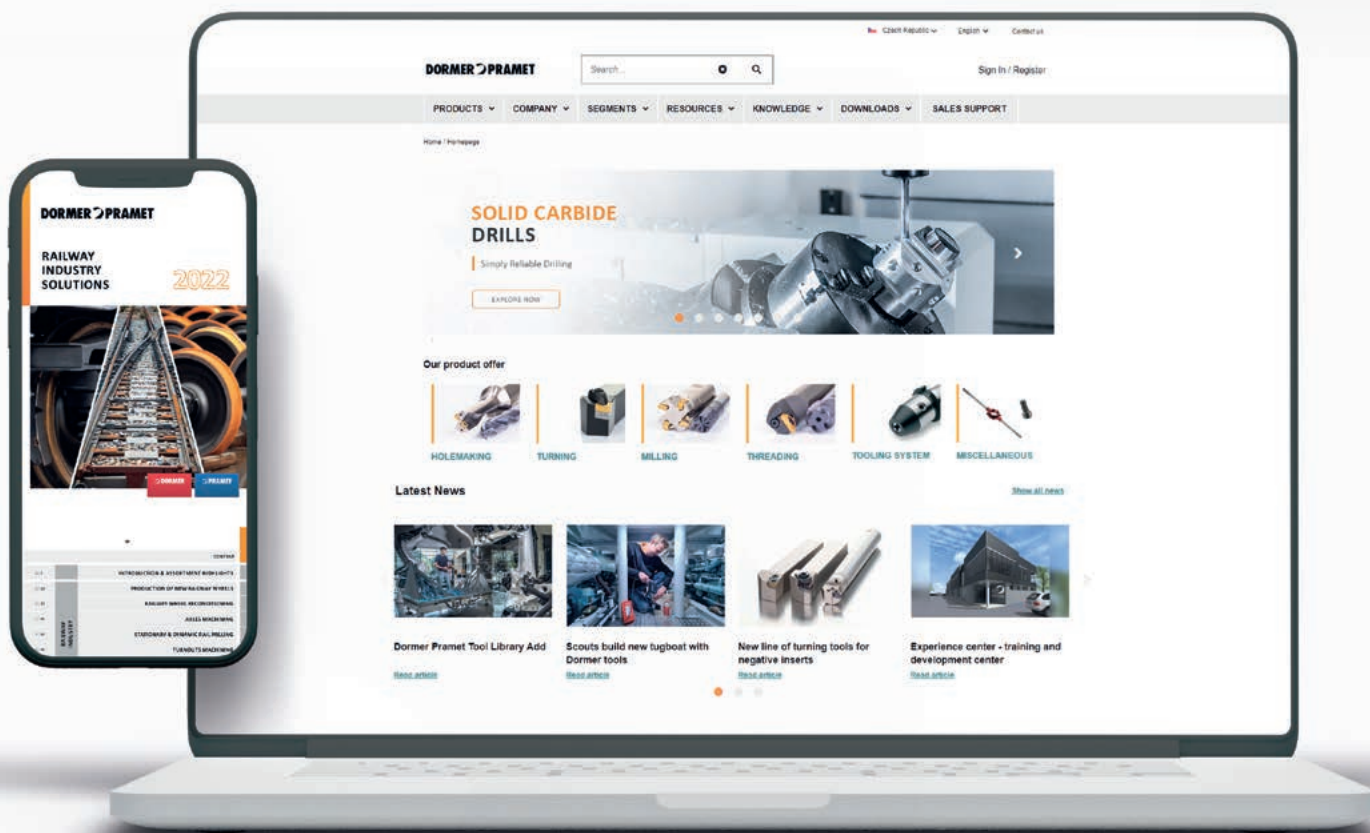



T8430

ADDITIONAL CHIPBREAKERS AND RADII

INTRODUCTION



We are expanding the Pramet assortment of our flagship PVD grade T8430 – the most versatile grade for general turning, heavy roughing and unfavourable conditions. Excellent for steel and cast steel, the grade also performs well in stainless steel, cast iron and super alloys. The additions include negative inserts with chipbreakers NMR, NRM and RM, which are now available in bigger corner radii, increasing their application range, performance and tool life in rouging operations.

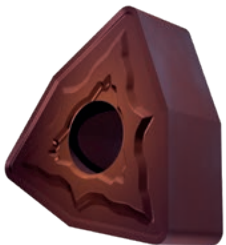

NMR

- Versatile geometry
- Soft steels, stainless steels
- Light to medium cuts

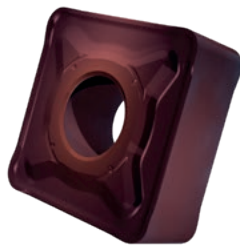

NRM

- Roughing geometry
- Soft steels, stainless steels
- Medium to rough cuts

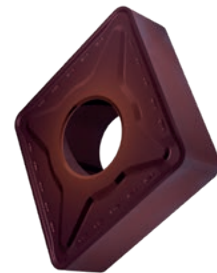

RM

- Versatile geometry
- Steels, stainless steels, cast irons
- Medium to rough cuts



NEGATIVE TURNING INSERTS

FEATURES & BENEFITS

A multi-layered PVD coating.



VERSATILE

usage for a broad range of operations.

Unique TiBN top layer reduces build-up edge in lower cutting speeds.



TOOL LIFE

greatly improved, especially in steels.

Assortment expanded by bigger radii, increasing roughing capability.



PRODUCTIVITY

increased due to wider feed rate range.

Shallow geometries NMR, NRM and RM with wide positive T-land.



APPLICATION RANGE

expanded for most workpiece materials.

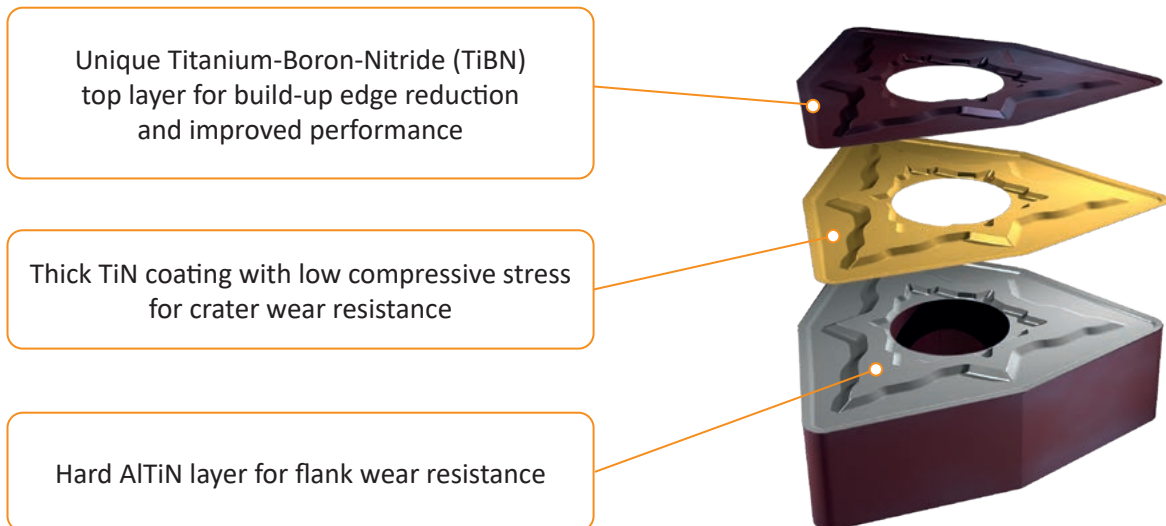

APPLICATION AREA OF PVD TURNING GRADES

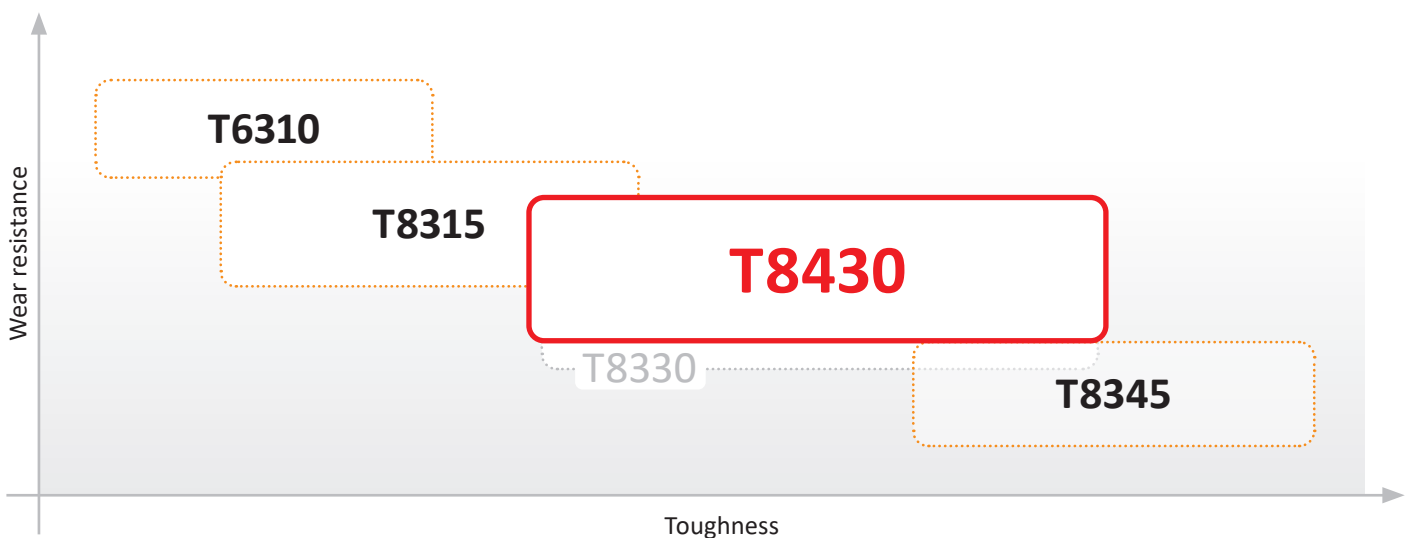



KR

CAST IRON TURNING EXPANSION

INTRODUCTION



Our family of turning inserts for cast iron and abrasive materials has been expanded with new shapes and radii. All the newly added inserts feature a strong KR chipbreaker with a wide neutral T-land and secure rounding of the cutting edge, in combination with a thick coated MT-CVD T5315 grade.

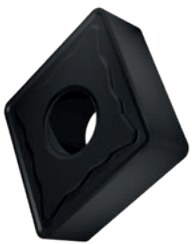
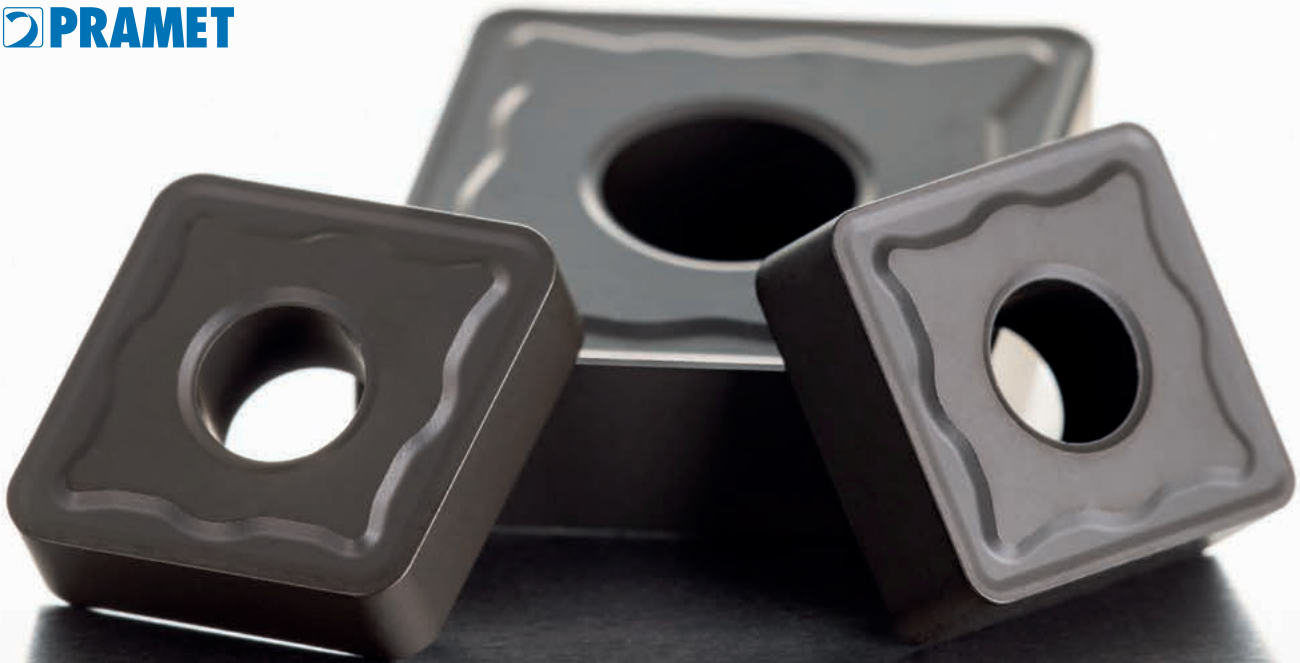

CVMG-KR

- Productive insert
- Cast irons, hard steels
- Medium to rough cuts



SNMG-KR

- Roughing insert
- Cast irons, hard steels
- Medium to rough cuts

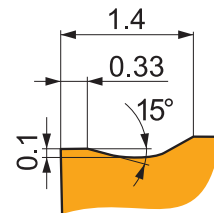

KR

- Designed for semi-rough and rough machining, cast irons, potentially steel and hard materials, continuous and interrupted cuts.



NEGATIVE TURNING INSERTS

FEATURES & BENEFITS

Strong geometry KR with wide neutral T-land and rounded cutting edge.



RELIABLE AND SECURE

cutting process in cast iron turning.

Available in MT-CVD grade T5315 with thick TiCN and Al₂O₃ coating layers.



LONG TOOL LIFE

achieved in abrasive materials.

Assortment expanded by bigger radii, increasing roughing capability.



APPLICATION RANGE

expanded for heavier operations.

Stable cutting edge geometry

Thick MT-CVD coating

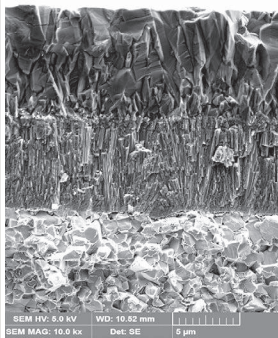

T5315

- MT-CVD grade
- Thick TiCN and Al₂O₃
- Abrasion resistance



DNMG-KR

- Versatile insert
- Cast irons, hard steels
- Light to rough cuts

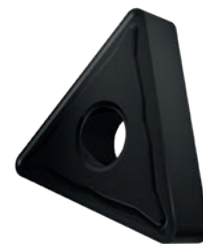

TNMG-KR

- Economical insert
- Cast irons, hard steels
- Light to medium cuts



S-TYPE

SLIDING HEAD TURNING TOOLS

INTRODUCTION



Small metric external turning tools dedicated for sliding head machines (or swiss type machines) have been added to the Pramet turning range. All tools have C lock ISO clamping style for small CC, DC, TC, VB and VC inserts. This makes them ideal for small parts machining. When a precise functional width is aligned to the shank side (WF = B), then indexing is even more accurate.



SCAC(RL)-S

- External tools for CC.. 09 inserts
- Shank sizes 12 × 12, 16 × 16 mm
- KAPR 90°



SCLC(RL)-S

- External tools for CC.. 09 inserts
- Shank sizes 12 × 12, 16 × 16 mm
- KAPR 95°



SDFC(RL)-S

- External tools for DC.. 07, 11 inserts
- Shank sizes 12 × 12, 16 × 16 mm
- KAPR 91°



SDJC(RL)-S

- External tools for DC.. 07, 11 inserts
- Shank sizes 12 × 12, 16 × 16 mm
- KAPR 93°



FEATURES & BENEFITS

Specifically designed tools for sliding head machines.



HIGH LEVEL OF PRECISION

when changing tools (where $WF = B$).

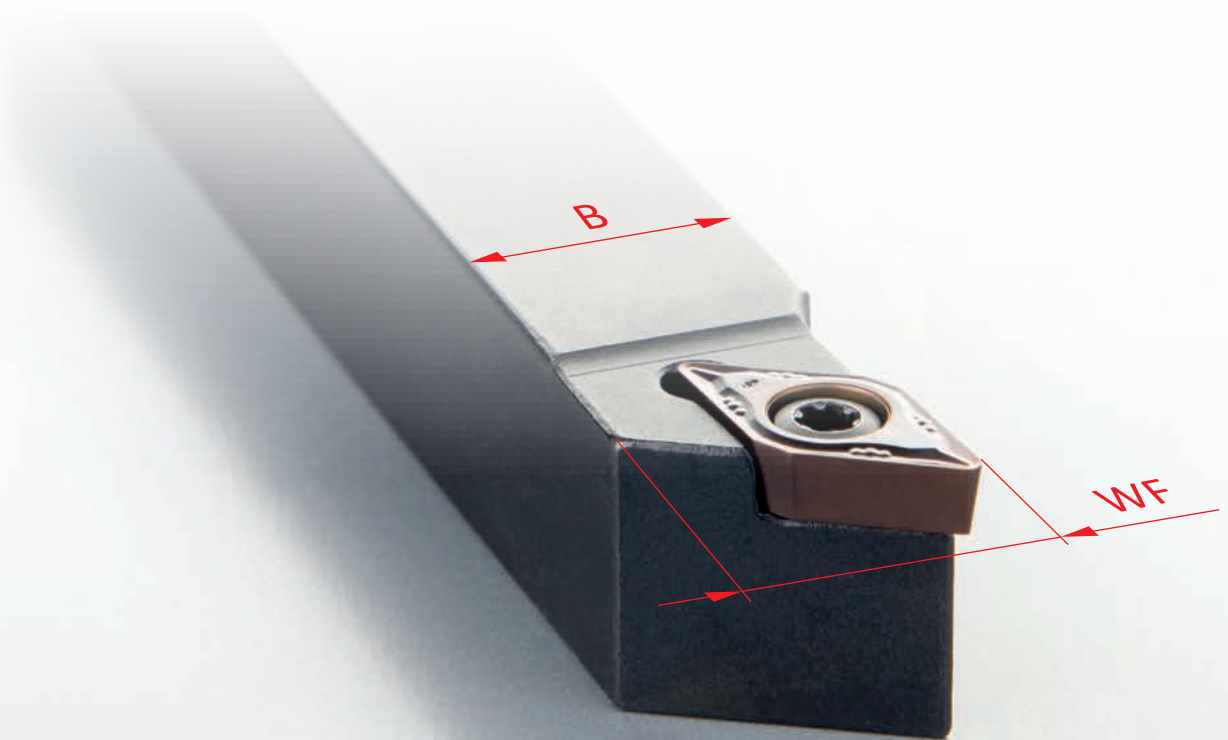

SDUCL-S

- External tools for DC.. 07 inserts
- Shank diameters 20 and 30 mm
- KAPR 93°



SDXC(RL)-S

- External tools for DC.. 07, 11 inserts
- Shank sizes 12 × 12, 16 × 16 mm
- KAPR 62.5°



STAC(RL)-S

- External tools for TC.. 11 inserts
- Shank sizes 12 × 12, 16 × 16 mm
- KAPR 91°



SVJB(RL)-S

- External tools for VB.. 11, VC.. 11
- Shank sizes 12 × 12, 16 × 16 mm
- KAPR 93°



INTRODUCTION



We are introducing a new line of type P (lever clamping style) and type M (wedge top clamping style) turning tools and boring bars with a new design and surface treatment. All holders are now nickelized for higher oxidation and wear resistance. Also, all boring bars have internal coolant channels for longer insert tool life and better chip evacuation. Important note: Some spare parts, dimensions or setting angles can be different than in previously available tools.

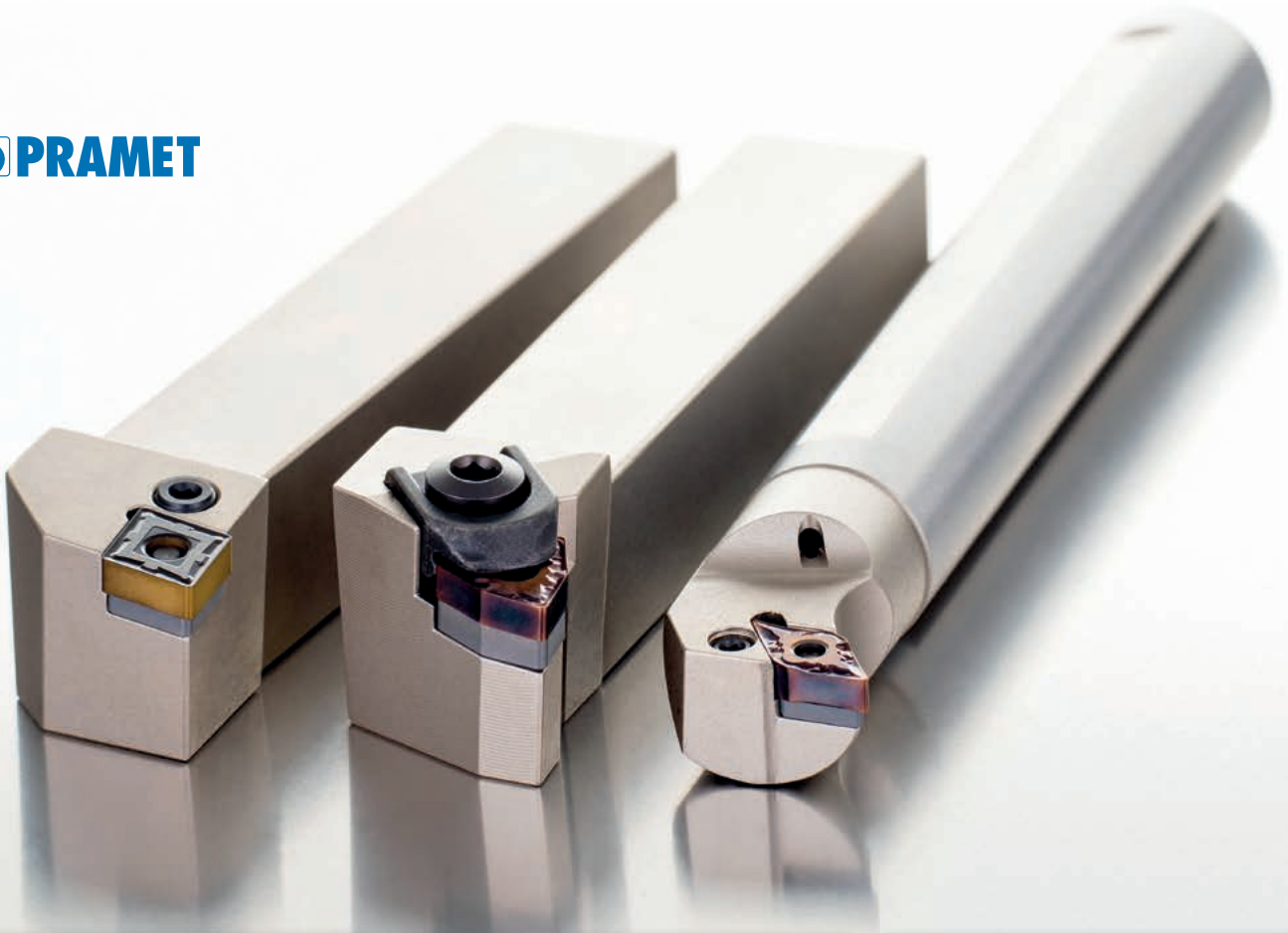

P (EXT)

- External tools with lever clamping



M (EXT)

- External tools with wedge top clamp



P (INT)

- Boring bars with lever clamping



FEATURES & BENEFITS

Nickelized tool bodies made of high quality tool steel.



HIGH DURABILITY
and oxidation resistance.

Internal coolant channels in all boring bars.



IMPROVED INSERT TOOL LIFE
due to reduced heat on cutting edge.



Nickelized tools for
oxidation protection

Internal coolant
channels



SON06C

ECONOMICAL 16-EDGED FACE MILLING

INTRODUCTION



A new highly economical face milling family has been launched. The latest Pramet range includes three variants of a 16-edged ONMX insert for depths of cut up to 4 mm. This includes a specific wiper insert ONMX-W for high quality surface finish in high feeds, and two variants of 8-edged roughing insert SNMX for depths of cut up to 7 mm. Several geometries and cutters are available for machining a wide range of materials.

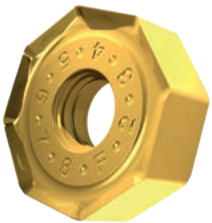

ONMX-F

- Economical 16-edged pressed insert
- Steels, stainless steels and HRSA
- Light cuts



ONMX-M

- Economical 16-edged pressed insert
- Steels, hard steels, stainless steels, HRSA
- Medium cuts



ONMX-R

- Economical 16-edged pressed insert
- Steels, cast irons, hard steels
- Rough cuts



MILLING CUTTERS AND INSERTS

INSERTS FEATURES & BENEFITS

Octagonal, directly pressed negative inserts.

▶ **16 CUTTING EDGES**
for even greater economy and cost saving.

Geometries F, M and R on inserts ONMX.

▶ **EASY TO SELECT**
a geometry for light, medium or rough cuts.

Optimized combination of grades and geometries.

▶ **VERSATILE USE**
in wide range of workpiece materials.

Square, directly pressed negative inserts.

▶ **8 CUTTING EDGES**
insert SNMX for depth of cut up to 7 mm.

High depth of cut capability on SNMX inserts.

▶ **HIGH METAL REMOVAL RATE**
in economical solution.

Additional wiper insert ONMX-W available.

▶ **HIGH SURFACE QUALITY**
in larger diameter cutters and higher feeds.

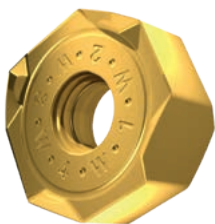
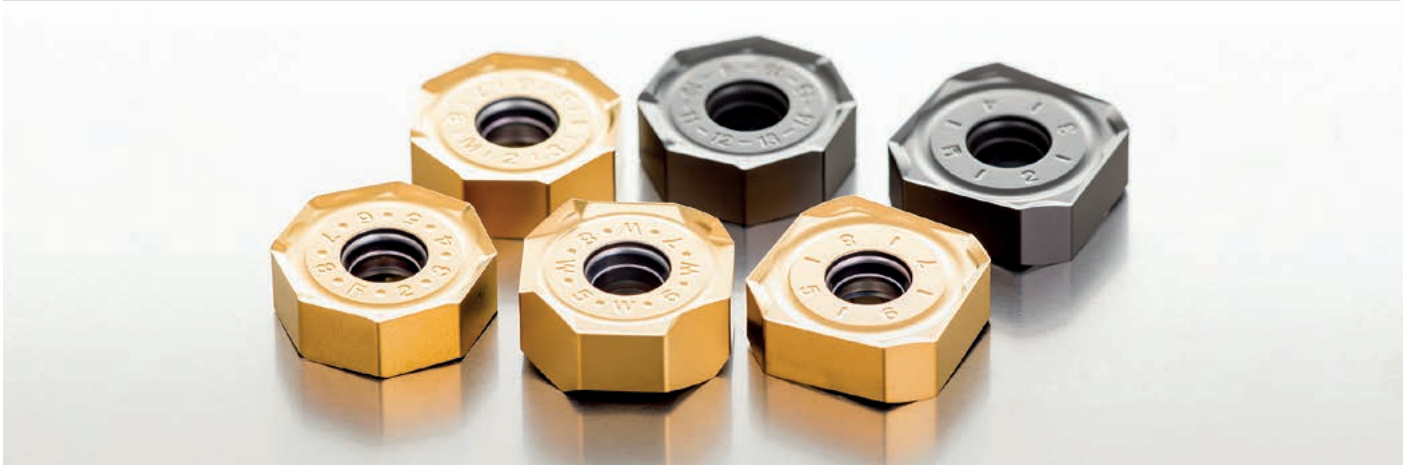

ONMX-W

- Wiper insert
- Steels, stainless steels
- High quality surface finish

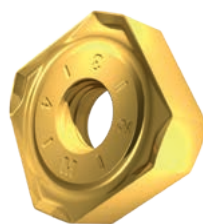

SNMX-M

- Economical 8-edged roughing insert
- Steels, hard steels, stainless steels, HRSA
- Medium cuts

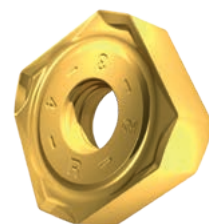

SNMX-R

- Economical 8-edged roughing insert
- Steels, cast irons, hard steels
- Rough cuts



SON06C

ECONOMICAL 16-EDGED FACE MILLING

CUTTERS SON06C – FEATURES & BENEFITS

Cutter body made of high quality, nickelized tool steel.

▶ **HIGH DURABILITY**
of hardened cutter body.

Strong clamping screw and easily accessible hardened insert seat.

▶ **SIMPLE AND SAFE**
clamping of insert.

Internal coolant on entire assortment, including large-sized diameters.

▶ **IMPROVED TOOL LIFE**
and better chip evacuation, providing high surface quality and reliability.

Shell type cutters available in wide diameter range and various tooth pitches.

▶ **VARIOUS OPTIONS**
for a broad range of applications.



SON06C

- Shell body
- DC range
50 – 250 mm
2.00 – 6.00 inch



MILLING CUTTERS AND INSERTS

FACE MILLING EXAMPLES

Workpiece: Carbon steel plate (210 HB)
 Material: 1.1191 / C45
 Cutter: 63A06R-S45ON06-C
 Coolant: Compressed air

Cutting conditions			
v_c (m/min)	f_z (mm)	a_p (mm)	a_e (mm)
250	0.25	2	50
Insert geometry test			Tool life (min)
ONMX 060508SR- M :M8330			42

ONMX 060508SR-**M**:M8330, 42 min

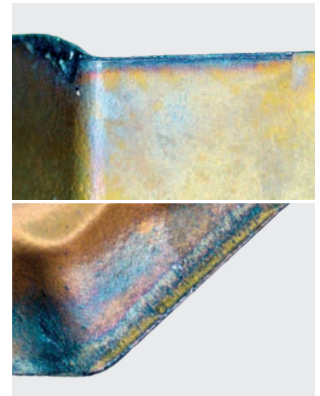

WMG P2.2

Workpiece: Stainless steel plate (145 HB)
 Material: 1.4404 / 316L
 Cutter: 63A06R-S45ON06-C
 Coolant: Compressed air

Cutting conditions			
v_c (m/min)	f_z (mm)	a_p (mm)	a_e (mm)
160	0.15	2	50
Insert geometry test			Tool life (min)
ONMX 060508SR- F :M6330			58

ONMX 060508SR-**F**:M6330, 58 min

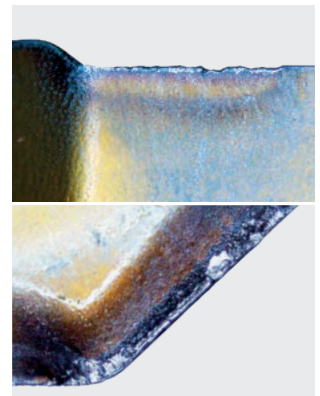

WMG M3.1

Workpiece: Stainless steel plate (145 HB)
 Material: 1.4404 / 316L
 Cutter: 63A06R-S45ON06-C
 Coolant: Soluble oil emulsion (~ 10%)

Cutting conditions			
v_c (m/min)	f_z (mm)	a_p (mm)	a_e (mm)
80	0.15	2	50
Insert geometry test			Tool life (min)
ONMX 060508SR- F :M6330			56

ONMX 060508SR-**F**:M6330, 56 min

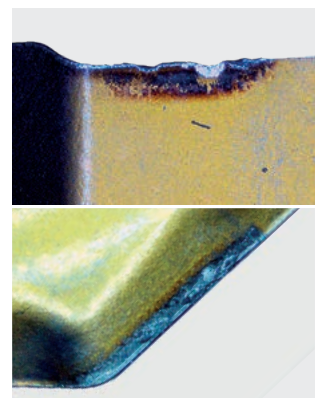

WMG M3.1

Workpiece: Cast iron plate (205 HB)
 Material: GG25 / FC250
 Cutter: 63A06R-S45ON06-C
 Coolant: Compressed air

Cutting conditions			
v_c (m/min)	f_z (mm)	a_p (mm)	a_e (mm)
250	0.4	2	50
Insert geometry test			Tool life (min)
ONMX 060508SR- R :M5315			137+

ONMX 060508SR-**R**:M5315, 137 min

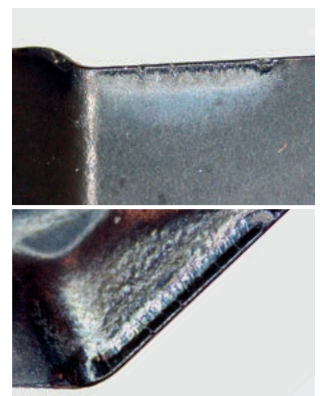

WMG K1.2



SON06C



PRAMET

S

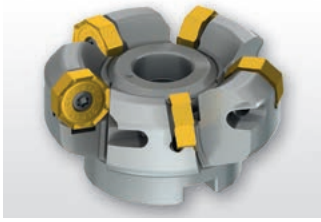

ECON ON06 43° Face Mill with Double Negative Design and Internal Coolant

Highly economical and productive face mill utilising two types of double-sided negative inserts. Economical octagonal ON..06 inserts with 16 cutting edges and APMX of 4 mm, and productive square SN.. 17 inserts with 8 cutting edges and APMX of 7 mm. Arbor style available with differential tooth pitch. Body treated for longer tool life.

KAPR	43°
APMX	4.0 (7.0)

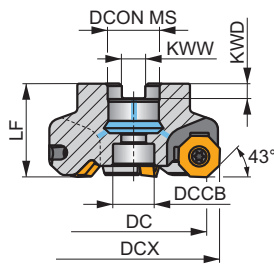
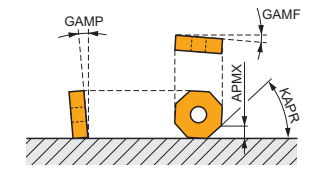

DC 50 – 125 mm

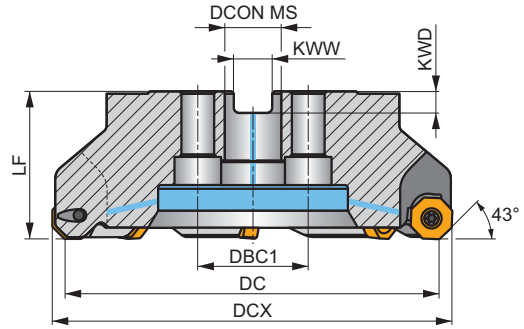

DC 160 – 250 mm

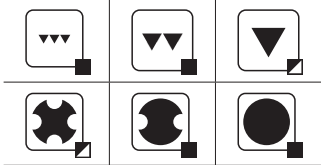

h_m 0.04 - 0.25

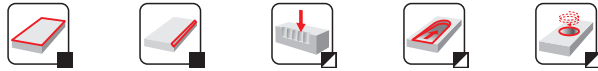

Product	DC	DCX	DCON MS	DCCB	DBC1	LF	KWW	KWD	GAMF	GAMP	max.	kg	G1342	C0621	C0622	C0623	C0624	C0625
	(mm)	(mm)		(mm)	(mm)													
50A04R-S450N06-C	50	60.8	22	16.5	-	40	10.4	6.3	-10	-5	4	✓	9400	✓	0.42	G1342	C0621	-
50A05R-S450N06-C	50	60.8	22	16.5	-	40	10.4	6.3	-10	-5	5	-	9400	✓	0.39	G1342	C0621	-
63A05R-S450N06-C	63	73.8	22	18.1	-	40	10.4	6.3	-10	-5	5	✓	8400	✓	0.59	G1342	C0621	-
63A06R-S450N06-C	63	73.8	22	18.1	-	40	10.4	6.3	-10	-5	6	✓	8400	✓	0.55	G1342	C0621	-
80A06R-S450N06-C	80	90.8	27	22.1	-	50	12.4	7	-10	-5	6	✓	7500	✓	1.27	G1342	C0622	-
80A08R-S450N06-C	80	90.8	27	22.1	-	50	12.4	7	-10	-5	8	-	7500	✓	1.19	G1342	C0622	-
100A08R-S450N06-C	100	110.8	32	30.1	-	50	14.4	8	-10	-5	8	✓	6700	✓	1.88	G1342	C0620	AC002
100A10R-S450N06-C	100	110.8	32	30.1	-	50	14.4	8	-10	-5	10	-	6700	✓	1.81	G1342	C0620	AC002
125A08R-S450N06-C	125	135.8	40	56.1	-	63	16.4	9	-10	-5	8	✓	6000	✓	3.53	G1342	C0620	AC003
125A10R-S450N06-C	125	135.8	40	56.1	-	63	16.4	9	-10	-5	10	✓	6000	✓	3.65	G1342	C0620	AC003
125A12R-S450N06-C	125	135.8	40	56.1	-	63	16.4	9	-11	-5	12	-	6000	✓	3.55	G1342	C0620	AC003
160C08R-S450N06-C	160	170.8	40	-	66.7	63	16.4	9.25	-10	-5	8	✓	5700	✓	5.54	G1342	C0623	-
160C12R-S450N06-C	160	170.8	40	-	66.7	63	16.4	9.25	-10	-5	12	✓	5700	✓	5.74	G1342	C0623	-
160C14R-S450N06-C	160	170.8	40	-	66.7	63	16.4	9.25	-11	-5	14	-	5700	✓	5.65	G1342	C0623	-
200C12R-S450N06-C	200	210.8	60	-	101.6	63	25.8	14.25	-10	-5	12	✓	4700	✓	9.00	G1342	C0624	-
200C16R-S450N06-C	200	210.8	60	-	101.6	63	25.8	14.25	-10	-5	16	-	4700	✓	9.02	G1342	C0624	-
250C14R-S450N06-C	250	260.8	60	-	101.6	63	25.8	14.25	-10	-5	14	✓	4300	✓	15.46	G1342	C0625	-
250C18R-S450N06-C	250	260.8	60	-	101.6	63	25.8	14.25	-10	-5	18	-	4300	✓	15.51	G1342	C0625	-

G1342	ONMX 0605..	ONMX 0605..-W..	SNMX 1705..
-------	-------------	-----------------	-------------



CO620	US 45013A-T20P	5.0	M 5	13	SDR T20P-T	-	-	-	-
CO621	US 45013A-T20P	5.0	M 5	13	SDR T20P-T	HS 1030C	-	-	-
CO622	US 45013A-T20P	5.0	M 5	13	SDR T20P-T	HS 1230C	-	-	-
CO623	US 45013A-T20P	5.0	M 5	13	SDR T20P-T	HS 1240C	CAC 160C	HSD 0825C	HXK 5
CO624	US 45013A-T20P	5.0	M 5	13	SDR T20P-T	HS 1655C	CAC 200C	HSD 1025C	HXK 7
CO625	US 45013A-T20P	5.0	M 5	13	SDR T20P-T	HS 1655C	CAC 250C	HSD 1025C	HXK 7

AC002		KS 1635	K.FMH32
AC003		KS 2040	K.FMH40

ONMX 06



	IC (mm)	D1 (mm)	S (mm)
0605	17.000	5.70	7.08

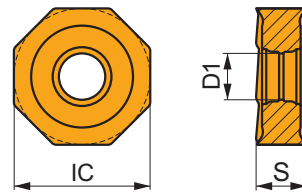

Suitability and starting values for cutting speed (vc), feed (f) and depth of cut (ap). Refer to our Machining Calculator app for further calculations.

Product	RE (mm)	P			M			K			N			S			H		
		vc (m/min)	f (mm/tooth)	ap (mm)	vc (m/min)	f (mm/tooth)	ap (mm)	vc (m/min)	f (mm/tooth)	ap (mm)	vc (m/min)	f (mm/tooth)	ap (mm)	vc (m/min)	f (mm/tooth)	ap (mm)	vc (m/min)	f (mm/tooth)	ap (mm)

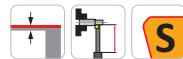
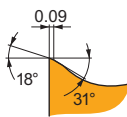
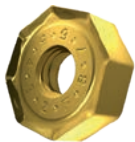

F geometry is sharp and used for finishing, suitable for large overhang or thin walled and slim workpiece applications. Designed with highly positive rake, narrow T-land and rounding of cutting edge for light machining.

ONMX 060508SR-F	8215	0.8	275	0.10	2.0	165	0.09	2.0	-	-	-	-	-	-	65	0.07	1.6	-	-	-
	M6330	0.8	230	0.10	2.0	165	0.09	2.0	-	-	-	-	-	-	65	0.07	1.6	-	-	-
	M8330	0.8	270	0.10	2.0	160	0.09	2.0	-	-	-	-	-	-	65	0.07	1.6	-	-	-
	M8340	0.8	245	0.10	2.0	145	0.09	2.0	-	-	-	-	-	-	60	0.07	1.6	-	-	-
	M9340	0.8	320	0.10	2.0	190	0.09	2.0	-	-	-	-	-	-	80	0.07	1.6	-	-	-

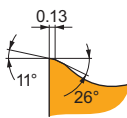

M geometry is versatile and the first choice for a wide range of working conditions. Designed with positive rake, medium T-land and rounding of cutting edge for medium machining.

ONMX 060508SR-M	8215	0.8	230	0.20	2.0	135	0.18	2.0	-	-	-	-	-	-	55	0.14	1.6	45	0.14	1.0
	M6330	0.8	195	0.20	2.0	140	0.18	2.0	-	-	-	-	-	-	55	0.14	1.6	-	-	-
	M8330	0.8	230	0.20	2.0	135	0.18	2.0	-	-	-	-	-	-	55	0.14	1.6	45	0.14	1.0
	M8340	0.8	210	0.20	2.0	125	0.18	2.0	-	-	-	-	-	-	50	0.14	1.6	-	-	-
	M9325	0.8	285	0.20	2.0	-	-	-	-	-	-	-	-	-	-	-	-	55	0.14	1.0
	M9340	0.8	255	0.20	2.0	150	0.18	2.0	-	-	-	-	-	-	60	0.14	1.6	-	-	-



Suitability and starting values for cutting speed (vc), feed (f) and depth of cut (ap). Refer to our Machining Calculator app for further calculations.

Product	RE (mm)	P			M			K			N			S			H		
		vc (m/min)	f (mm/tooth)	ap (mm)	vc (m/min)	f (mm/tooth)	ap (mm)	vc (m/min)	f (mm/tooth)	ap (mm)	vc (m/min)	f (mm/tooth)	ap (mm)	vc (m/min)	f (mm/tooth)	ap (mm)	vc (m/min)	f (mm/tooth)	ap (mm)

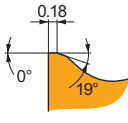

R geometry is strong and used for roughing and heavy working conditions. Designed with slightly positive rake, wide T-land and rounding of cutting edge for rough machining.

ONMX 060508SR-R	8215	0.8	210	0.30	2.0	–	–	–	195	0.30	2.0	–	–	–	–	–	–	–	40	0.21	1.0
	M5315	0.8	255	0.30	2.0	–	–	–	240	0.30	2.0	–	–	–	–	–	–	–	50	0.21	1.0
	M8330	0.8	210	0.30	2.0	–	–	–	195	0.30	2.0	–	–	–	–	–	–	–	40	0.21	1.0
	M8340	0.8	190	0.30	2.0	–	–	–	180	0.30	2.0	–	–	–	–	–	–	–	–	–	–
	M9325	0.8	250	0.30	2.0	–	–	–	235	0.30	2.0	–	–	–	–	–	–	–	50	0.21	1.0

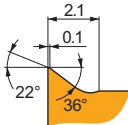
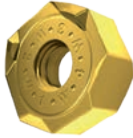

Wiper design for improved surface finish when machining with large cutters and high feed rate.

ONMX 060508SR-W	8215	0.8	340	0.10	0.3	200	0.09	0.3	–	–	–	–	–	–	–	–	–	–	–	–	–
	M8330	0.8	325	0.10	0.3	195	0.09	0.3	–	–	–	–	–	–	–	–	–	–	–	–	–

SNMX 17



	IC (mm)	D1 (mm)	S (mm)
1705	17.000	5.70	5.56

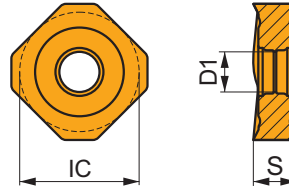

Suitability and starting values for cutting speed (vc), feed (f) and depth of cut (ap). Refer to our Machining Calculator app for further calculations.

Product	RE (mm)	P			M			K			N			S			H		
		vc (m/min)	f (mm/tooth)	ap (mm)	vc (m/min)	f (mm/tooth)	ap (mm)	vc (m/min)	f (mm/tooth)	ap (mm)	vc (m/min)	f (mm/tooth)	ap (mm)	vc (m/min)	f (mm/tooth)	ap (mm)	vc (m/min)	f (mm/tooth)	ap (mm)

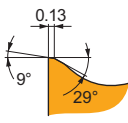
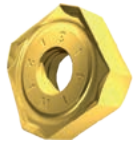

M geometry is versatile and the first choice for a wide range of working conditions. Designed with positive rake, medium T-land and rounding of cutting edge for medium machining.

SNMX 170508SR-M	8215	0.8	265	0.20	4.0	155	0.18	4.0	–	–	–	–	–	–	65	0.14	3.2	50	0.14	1.0
	M6330	0.8	225	0.20	4.0	160	0.18	4.0	–	–	–	–	–	–	65	0.14	3.2	–	–	–
	M8330	0.8	265	0.20	4.0	155	0.18	4.0	–	–	–	–	–	–	65	0.14	3.2	50	0.14	1.0
	M8340	0.8	240	0.20	4.0	140	0.18	4.0	–	–	–	–	–	–	60	0.14	3.2	–	–	–
	M9325	0.8	325	0.20	4.0	–	–	–	–	–	–	–	–	–	–	–	–	65	0.14	1.0
	M9340	0.8	295	0.20	4.0	175	0.18	4.0	–	–	–	–	–	–	70	0.14	3.2	–	–	–

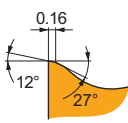
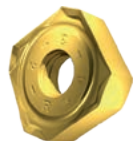

R geometry is strong and used for roughing and heavy working conditions. Designed with slightly positive rake, wide T-land and rounding of cutting edge for rough machining.

SNMX 170508SR-R	8215	0.8	240	0.30	4.0	–	–	–	225	0.30	4.0	–	–	–	–	–	–	–	45	0.21	1.0
	M5315	0.8	300	0.30	4.0	–	–	–	285	0.30	4.0	–	–	–	–	–	–	–	60	0.21	1.0
	M8330	0.8	240	0.30	4.0	–	–	–	225	0.30	4.0	–	–	–	–	–	–	–	45	0.21	1.0
	M8340	0.8	220	0.30	4.0	–	–	–	205	0.30	4.0	–	–	–	–	–	–	–	–	–	–
	M9325	0.8	290	0.30	4.0	–	–	–	275	0.30	4.0	–	–	–	–	–	–	–	55	0.21	1.0



a_s / DC	5%	10%	15%	20%	25%	30%	40%	50%	60%	70%	75%	80%	90%	100%
	1.48	1.35	1.27	1.22	1.19	1.16	1.11	1.08	1.05	1.03	1.00	1.00	1.00	1.00
	2.20	1.60	1.35	1.20	1.10	0.95	0.85	0.75	0.85	0.95	1.00	1.00	1.00	1.00
	0.64	0.64	0.64	0.64	0.64	0.65	0.65	0.67	0.68	0.71	0.72	0.74	0.79	1.00

	ONMX 06-F	ONMX 06-M	ONMX 06-R	ONMX 06-W	SNMX 17-M	SNMX 17-R
	0.80	0.80	0.80	0.80	0.80	0.80
	0.75	0.75	0.75	4.30	0.70	0.70

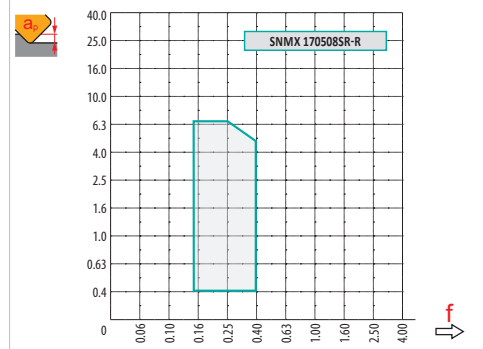
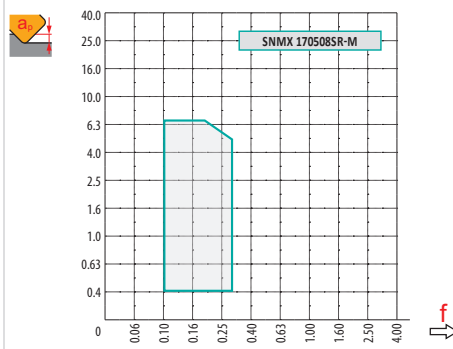
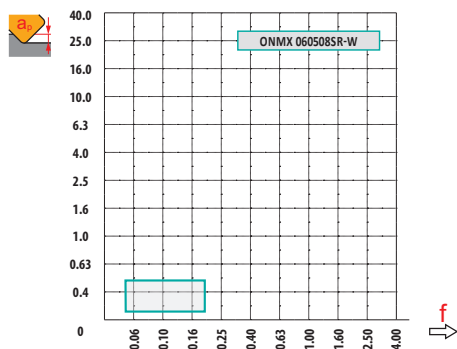
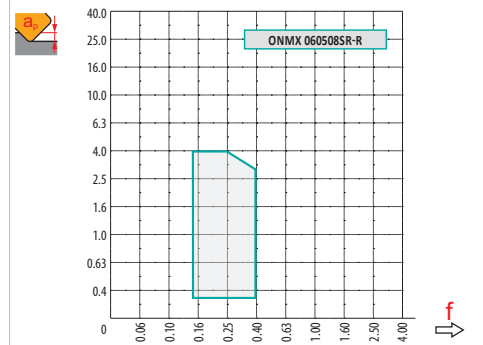
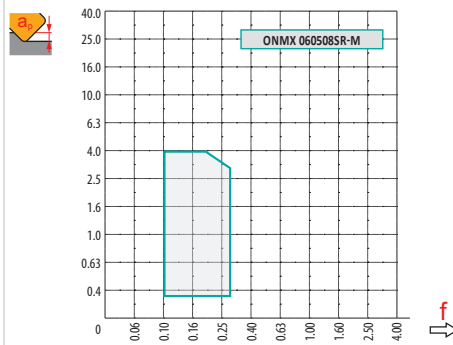
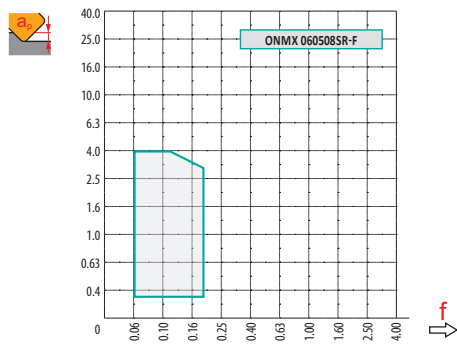

		0.50	1.00	1.50	2.00	2.50	3.00	3.50	4.00
50		51.06	52.11	53.19	54.27	55.35	56.43	57.51	58.59
63		64.06	65.11	66.19	67.27	68.35	69.43	70.51	71.59
80		81.06	82.11	83.19	84.27	85.35	86.43	87.51	88.59
100		101.06	102.11	103.19	104.27	105.35	106.43	107.51	108.59
125		126.06	127.11	128.19	129.27	130.35	131.43	132.51	133.59
160		161.06	162.11	163.19	164.27	165.35	166.43	167.51	168.59
200		201.06	202.11	203.19	204.27	205.35	206.43	207.51	208.59
250		251.06	252.11	253.19	254.27	255.35	256.43	257.51	258.59



DC	a _p	S							
		0.00	1.00	2.00	3.00	4.00	5.00	6.00	7.00
50	DEF	47.24	49.40	51.56	53.73	55.90	58.06	60.23	62.40
63		60.24	62.40	64.56	66.73	68.90	71.06	73.23	75.40
80		77.24	79.40	81.56	83.73	85.90	88.06	90.23	92.40
100		97.24	99.40	101.56	103.73	105.90	108.06	110.23	112.40
125		122.24	124.40	126.56	128.73	130.90	133.06	135.23	137.40
160		157.24	159.40	161.56	163.73	165.90	168.06	170.23	172.40
200		197.24	199.40	201.56	203.73	205.90	208.06	210.23	212.40
250		247.24	249.40	251.56	253.73	255.90	258.06	260.23	262.40



DC	X.V	f _{max}
50	1.35	0.36
63	1.39	0.40
80	1.44	0.45
100	1.48	0.51
125	1.53	0.57
160	1.58	0.64
200	1.63	0.72
250	1.68	0.80



DC	O	
	RPMX	APMX/I
50	0.3	0.4/100
63	0.2	0.25/100
80	0.2	0.2/100
100	0.1	0.1/100
125	0.1	0.05/100

DC	S	
	RPMX	APMX/I
47.24	0.1	0.1/100
60.24	0.1	0.05/100
77.24	0.1	0.05/100



DC	O			
	DMIN	DMAX	S MAX DMIN	S MAX DMAX
50	98	110	0.55	0.95
63	123	136	0.55	0.85
80	157	170	0.65	0.85
100	197	210	0.65	0.8
125	247	260	0.65	0.8
160	317	330	0.6	0.7
200	397	410	0.7	0.8
250	497	510	0.6	0.7



O
11.5

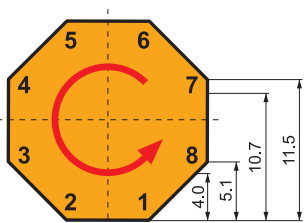

a _p	Number of Teeth
4.0	16
5.1	14
10.7	8
11.5	6

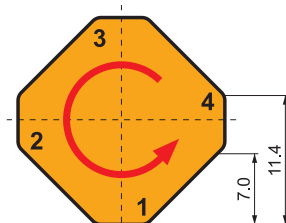

a _p	Number of Teeth
7.0	8
11.4	4

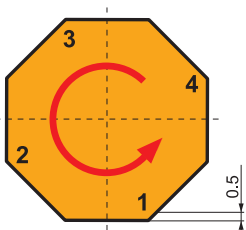

ONMX 06-W	
a _p	Number of Teeth
0.5	8



DORMER PRAMET



ALL IN ONE

All our publications in one place, tailored to your location and updated with the latest versions. What are you waiting for? Download our library app today from your relevant app store.

Simply Reliable.

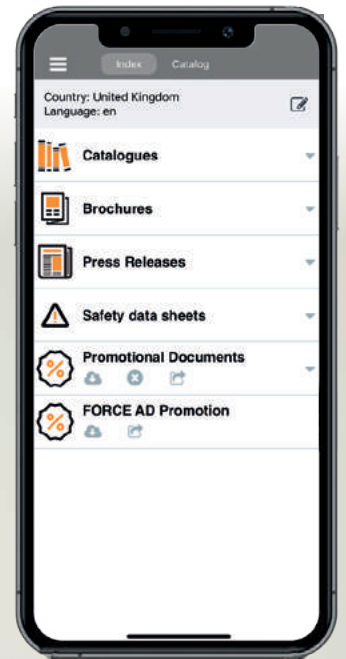



SSD13F

VERSATILE FACE MILLING

INTRODUCTION



A new face milling assortment for general engineering and maintenance, repair and operations has been launched. The latest Pramet range includes two economical and precise inserts (SDMT and SDET) for depths of cut up to 6.4 mm. Several geometries and cutters are available for machining a wide range of materials.

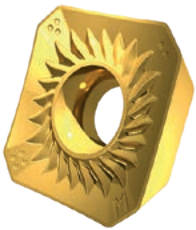
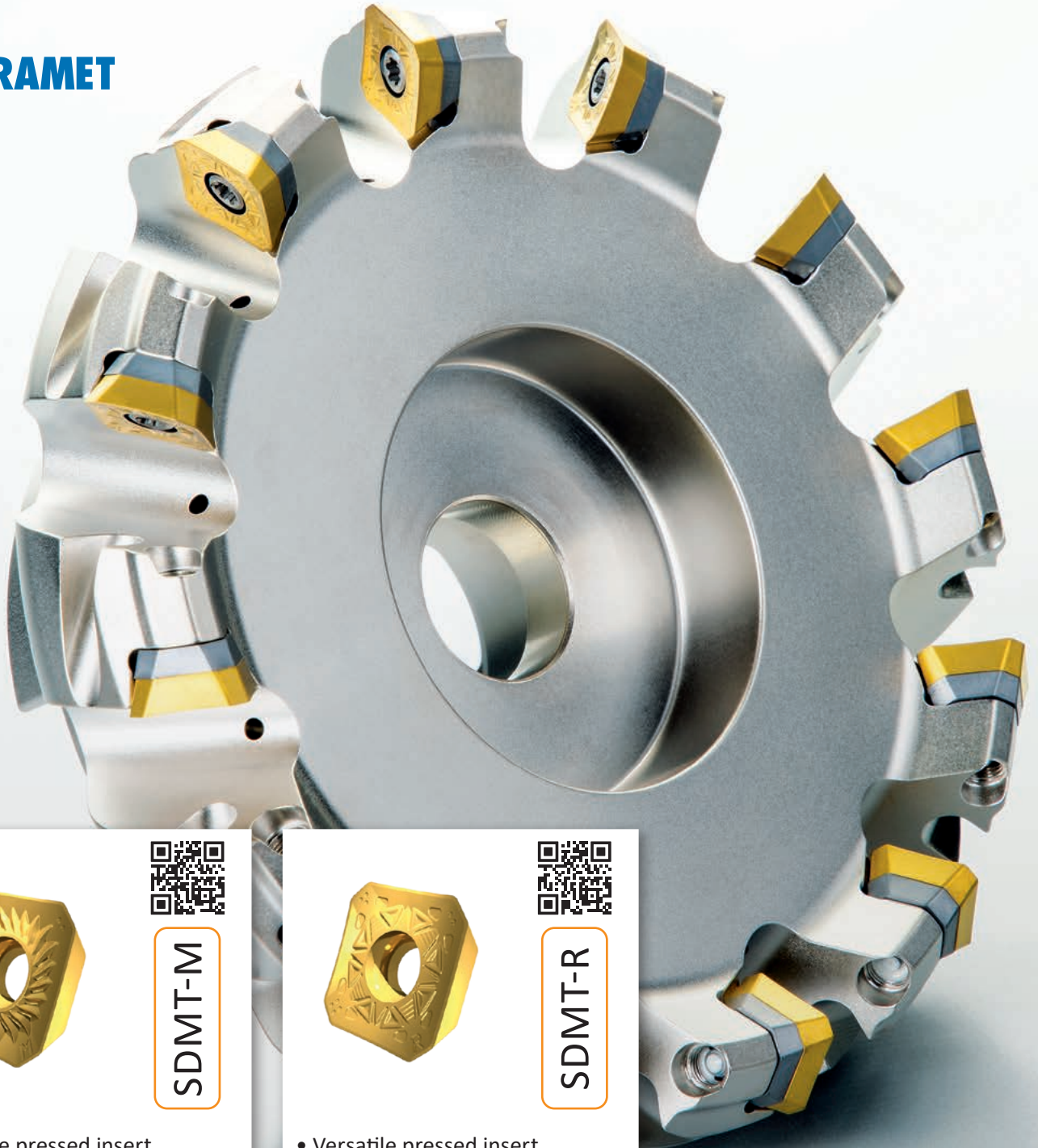

SDMT-M

- Versatile pressed insert
- Steels, cast irons and hard steels
- Medium cuts



SDMT-R

- Versatile pressed insert
- Steels, cast irons and hard steels
- Rough cuts



MILLING CUTTERS AND INSERTS

INSERTS FEATURES & BENEFITS

Application-specific geometries and grades.

EASY TO SELECT AND USE
for a wide range of workpiece materials.

Geometries M and R on economical pressed insert (SDMT 13).

LIGHT, MEDIUM AND ROUGH CUTS
in steels, cast irons and hard steels.

Sharp geometry F on precision ground insert (SDET 13).

SECURE AND SAFE
machining in stainless steels and heat resistant super alloys (HRSA).

Polished and extra sharp geometry FA on specific ground insert (SDET 13).

PRODUCTIVE MILLING
in non-ferrous materials.

Wide wiper edge design on all geometries.

HIGH SURFACE QUALITY
across multiple applications, from heavy roughing to finishing.

Additional wiper insert XDET 13 available.

PRODUCTIVE AND HIGH SURFACE QUALITY
in larger diameter cutters.

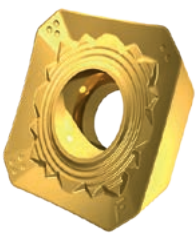

SDET-F

- Precision ground insert
- Stainless steels & HRSA
- Light to medium cuts

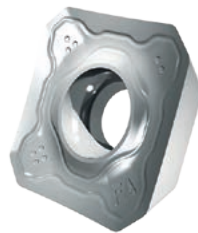

SDET-FA

- Precision ground insert
- Non-ferrous materials
- Light to rough cuts

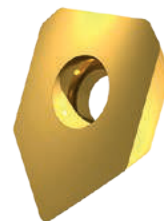

XDET

- Wiper insert
- Steels, cast irons, stainless steels
- High quality surface finish



SSD13F

VERSATILE FACE MILLING

CUTTERS SSD13F – FEATURES & BENEFITS

Weldon and shell-style cutters in diameters 32 – 250 mm (1.25 – 10.00 inch).



MULTIPLE CHOICES
for a wide range of machine sizes.

Carbide shim on cutter seating place.



EXTRA PROTECTION FOR HIGH DURABILITY
of cutter body, while providing insert stability and process security.

Internal coolant on entire assortment, including large-sized diameters.



IMPROVED TOOL LIFE
and better chip evacuation, providing high surface quality and reliability.

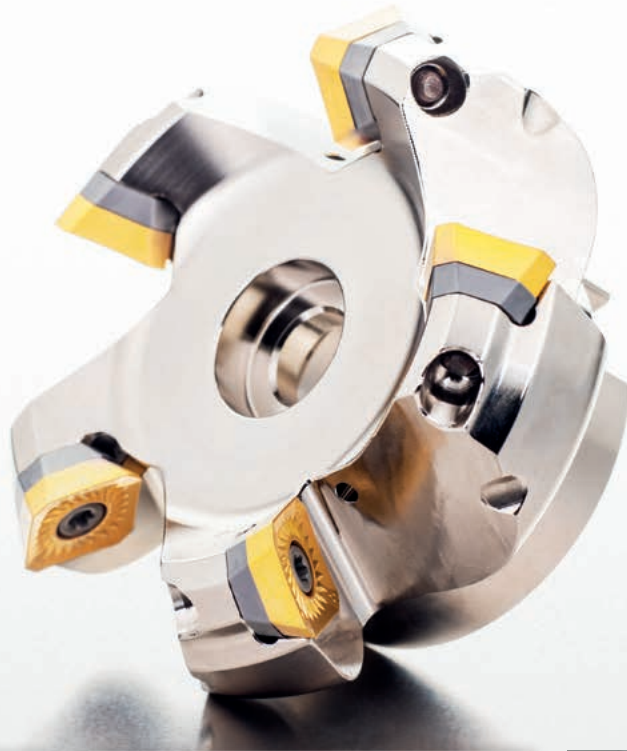



SSD13F

- Weldon shank
- DC range
32 – 40 mm
1.25 – 1.50 inch



SSD13F

- Shell body
- DC range
40 – 250 mm
1.50 – 10.00 inch

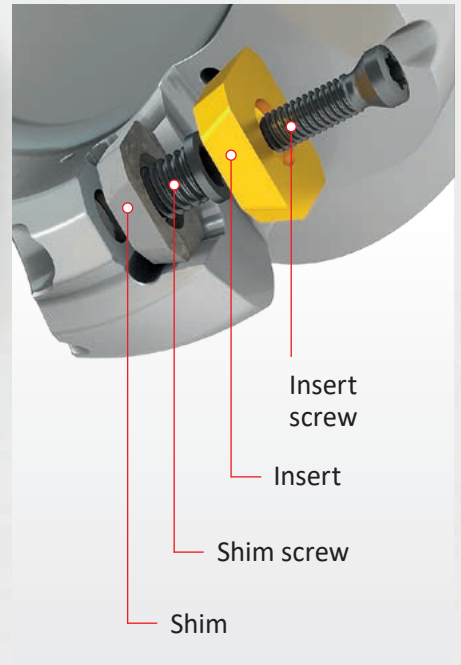



MILLING CUTTERS AND INSERTS

FACE MILLING EXAMPLES

Workpiece: Carbon steel plate (215 HB)
 Material: 1.1191 / C45
 Cutter: 63A05R-S45SD13F-C
 Coolant: Compressed air

Cutting conditions			
v_c (m/min)	f_z (mm)	a_p (mm)	a_e (mm)
250	0.25	2	50
Insert geometry			Tool life (min)
SDMT 13T3AFSN-M:M8330			97

SDMT 13T3AFSN-M:M8330, 97 min

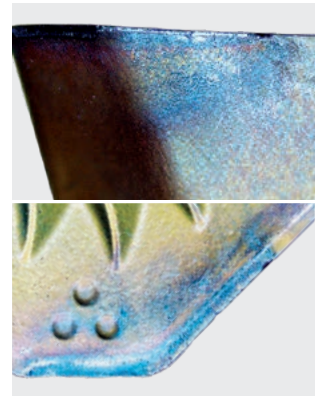

WMG P2.2

Workpiece: Stainless steel plate (145 HB)
 Material: 1.4404 / 316L
 Cutter: 63A05R-S45SD13F-C
 Coolant: Compressed air

Cutting conditions			
v_c (m/min)	f_z (mm)	a_p (mm)	a_e (mm)
120	0.15	2	50
Insert geometry			Tool life (min)
SDET 13T3AFSN-F:M6330			42

SDET 13T3AFSN-F:M6330, 42 min

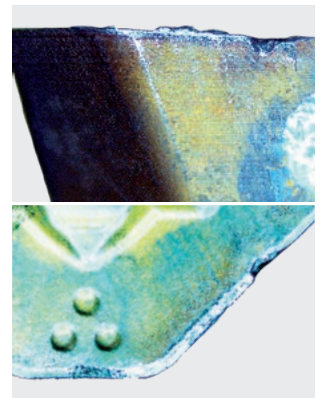

WMG M3.1

Workpiece: Stainless steel plate (145 HB)
 Material: 1.4404 / 316L
 Cutter: 63A05R-S45SD13F-C
 Coolant: Soluble oil emulsion (~ 10%)

Cutting conditions			
v_c (m/min)	f_z (mm)	a_p (mm)	a_e (mm)
80	0.15	2	50
Insert geometry			Tool life (min)
SDET 13T3AFSN-F:M6330			100

SDET 13T3AFSN-F:M6330, 100 min

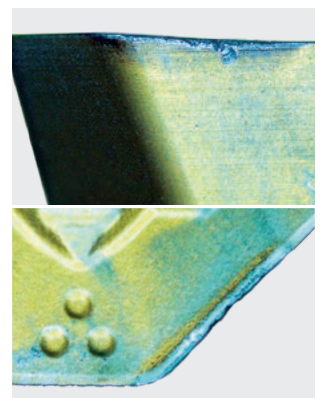

WMG M3.1

Workpiece: Cast iron plate (205 HB)
 Material: GG25 / FC250
 Cutter: 63A05R-S45SD13F-C
 Coolant: Compressed air

Cutting conditions			
v_c (m/min)	f_z (mm)	a_p (mm)	a_e (mm)
300	0.4	2	50
Insert geometry			Tool life (min)
SDMT 13T3AFSN-R:M5315			42

SDMT 13T3AFSN-R:M5315, 42 min

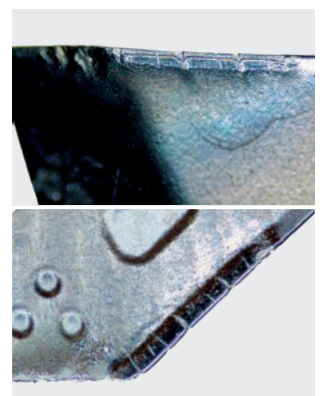

WMG K1.2



SSD13F



PRAMET

S



VER SD13 45° Face Mill with Positive Design and Internal Coolant

Highly versatile 45° face mill utilising single sided SD.. 13 style inserts with APMX of 6.4 mm. Suited for a wide range of applications in any workpiece material. Weldon and arbor style available, with differential tooth pitch. Body treated for longer tool life, carbide shims on seating place for process security.

KAPR	45°
APMX	6.4 mm

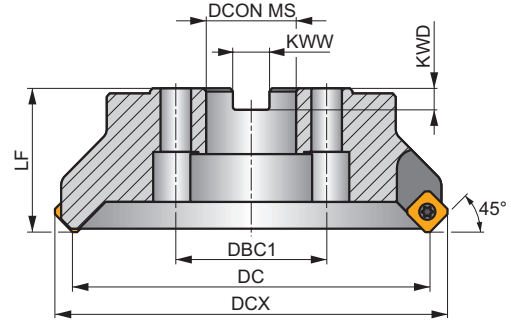
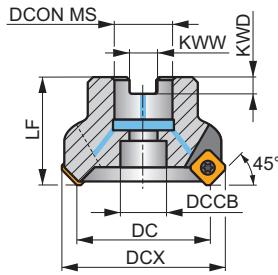
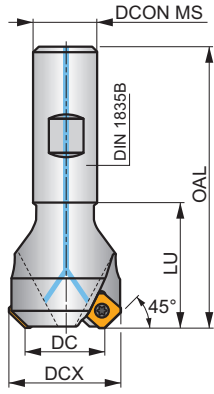
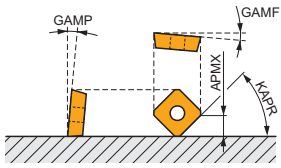

DC 40 – 125 mm

DC 160 – 250 mm

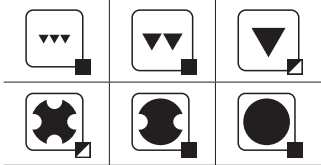

	0.04 - 0.32
	0.04 - 0.28



Product	DC	DCX	OAL	DCON MS	DCCB	DBC1	LU	LF	KWW	KWD	GAMF	GAMP	max.	kg	GI341	C0610	C0611	C0612	C0613	C0614	C0615	C0616
	(mm)	(mm)	(mm)	(mm)	(mm)	(mm)	(mm)	(mm)	(mm)	(mm)	(°)	(°)										
32N3R045B25-SSD13F-C	32	44.9	120	25	-	-	45	-	-	-	-15	15	3	-	16100	✓	0.43	GI341	C0610	-	-	-
40N3R045B32-SSD13F-C	40	53.5	120	32	-	-	45	-	-	-	-7	15	3	-	14400	✓	0.72	GI341	C0610	-	-	-
40A03R-S45SD13F-C	40	53.5	-	16	14	-	-	40	8.4	5.6	-7	15	3	-	14400	✓	0.27	GI341	C0611	-	-	-
50A04R-S45SD13F-C	50	63.5	-	22	18	-	-	40	10.4	6.3	-7	15	4	✓	12900	✓	0.51	GI341	C0612	-	-	-
63A05R-S45SD13F-C	63	76.4	-	22	18	-	-	40	10.4	6.3	-7	15	5	✓	11500	✓	0.53	GI341	C0612	-	-	-
80A07R-S45SD13F-C	80	93.4	-	27	22	-	-	50	12.4	7	-7	15	7	✓	10200	✓	1.32	GI341	C0613	AC001	-	-
100A08R-S45SD13F-C	100	112.9	-	32	45	-	-	50	14.4	8	-12	15	8	✓	9100	✓	1.83	GI341	C0613	AC002	-	-
100A10R-S45SD13F-C	100	112.9	-	32	45	-	-	50	14.4	8	-12	15	10	-	9100	✓	1.94	GI341	C0613	AC002	-	-
125A08R-S45SD13F-C	125	137.8	-	40	56	-	-	63	16.4	9	-12	15	8	✓	8100	✓	3.41	GI341	C0613	AC003	-	-
125A12R-S45SD13F-C	125	137.8	-	40	56	-	-	63	16.4	9	-12	15	12	-	8100	✓	3.31	GI341	C0613	AC003	-	-
160C10R-S45SD13F-C	160	172.8	-	40	-	66.7	-	63	16.4	9	-12	15	10	✓	7200	✓	6.69	GI341	C0614	-	-	-
160C14R-S45SD13F-C	160	172.8	-	40	-	66.7	-	63	16.4	9	-12	15	14	✓	7200	✓	6.62	GI341	C0614	-	-	-
200C12R-S45SD13F-C	200	212.8	-	60	-	101.6	-	63	25.7	14	-12	15	12	✓	6400	✓	9.06	GI341	C0615	-	-	-
200C16R-S45SD13F-C	200	212.8	-	60	-	101.6	-	63	25.7	14	-12	15	16	✓	6400	✓	11.85	GI341	C0615	-	-	-
250C14R-S45SD13F-C	250	262.8	-	60	-	101.6	-	63	25.7	14	-12	15	14	✓	5700	✓	19.50	GI341	C0616	-	-	-
250C20R-S45SD13F-C	250	262.8	-	60	-	101.6	-	63	25.7	14	-12	15	20	✓	5700	✓	19.20	GI341	C0616	-	-	-

GI341	SDET 13T3..	SDMT 13T3..	XDET 13T3..



CO610	US 63513-T15P	3.0	M 3.5	13	Flag T15P	–	–	–	SDW 1103AF	MS 3507	HXK 3.5	–	–	–
CO611	US 63513-T15P	3.0	M 3.5	13	–	D-T08P/T15P	FG-15	HS 0830C	SDW 1103AF	MS 3507	HXK 3.5	–	–	–
CO612	US 63513-T15P	3.0	M 3.5	13	–	D-T08P/T15P	FG-15	HSD 1025C	SDW 1103AF	MS 3507	HXK 3.5	–	–	–
CO613	US 63513-T15P	3.0	M 3.5	13	–	D-T08P/T15P	FG-15	–	SDW 1103AF	MS 3507	HXK 3.5	–	–	–
CO614	US 63513-T15P	3.0	M 3.5	13	–	D-T08P/T15P	FG-15	HS 1240C	SDW 1103AF	MS 3507	HXK 3.5	CAC 160C	HSD 0825C	HXK 5
CO615	US 63513-T15P	3.0	M 3.5	13	–	D-T08P/T15P	FG-15	HS 1655C	SDW 1103AF	MS 3507	HXK 3.5	CAC 200C	HSD 1025C	HXK 7
CO616	US 63513-T15P	3.0	M 3.5	13	–	D-T08P/T15P	FG-15	HS 1655C	SDW 1103AF	MS 3507	HXK 3.5	CAC 250C	HSD 1025C	HXK 7

AC001	KS 1230	K.FMH27
AC002	KS 1635	K.FMH32
AC003	KS 2040	K.FMH40

SDET 13



	IC	D1	M	S
	(mm)	(mm)	(mm)	(mm)
13T3	13.385	4.40	1.5	3.97

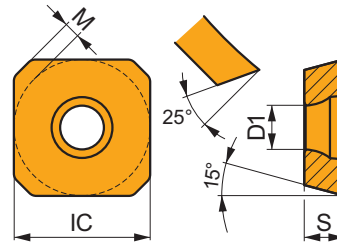

Suitability and starting values for cutting speed (vc), feed (f) and depth of cut (ap). Refer to our Machining Calculator app for further calculations.

Product	RE (mm)	P			M			K			N			S			H		
		vc (m/min)	f (mm/tooth)	ap (mm)	vc (m/min)	f (mm/tooth)	ap (mm)	vc (m/min)	f (mm/tooth)	ap (mm)	vc (m/min)	f (mm/tooth)	ap (mm)	vc (m/min)	f (mm/tooth)	ap (mm)	vc (m/min)	f (mm/tooth)	ap (mm)

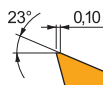

F geometry is sharp and used for finishing, suitable for large overhang or thin walled and slim workpiece applications. Designed with highly positive rake, narrow T-land and rounding of cutting edge for light machining.

SDET 13T3AFSN-F	M6330	–	250	0.15	3.0	175	0.14	3.0	–	–	–	–	–	–	70	0.11	2.4	–	–	–
	M8310	–	315	0.15	3.0	160	0.14	3.0	295	0.15	3.0	–	–	–	–	–	–	–	–	–
	M8330	–	285	0.15	3.0	170	0.14	3.0	270	0.15	3.0	855	0.18	3.0	70	0.11	2.4	–	–	–
	M8340	–	265	0.15	3.0	155	0.14	3.0	250	0.15	3.0	–	–	–	65	0.11	2.4	–	–	–
	M9340	–	330	0.15	3.0	195	0.14	3.0	–	–	–	–	–	–	80	0.11	2.4	–	–	–

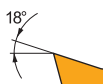
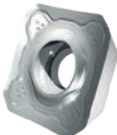

FA geometry is sharp and used for non-ferrous alloys machining, suitable for large overhang or thin walled and slim workpiece applications. Polished and ground design with highly positive rake.

SDET 13T3AFFN-FA	HF7	–	–	–	–	–	–	–	–	–	–	360	0.12	3.0	–	–	–	–	–	–
	M0315	–	–	–	–	–	–	–	–	–	–	840	0.12	3.0	–	–	–	–	–	–



SDMT 13



	IC	D1	M	S
	(mm)	(mm)	(mm)	(mm)
13T3	13.385	4.40	1.5	3.97

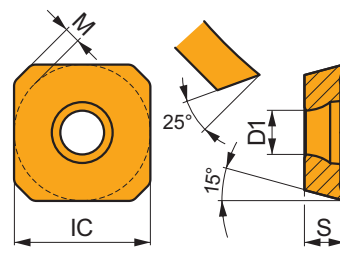

Suitability and starting values for cutting speed (vc), feed (f) and depth of cut (ap). Refer to our Machining Calculator app for further calculations.

Product	RE	P			M			K			N			S			H		
		vc	f	ap	vc	f	ap	vc	f	ap	vc	f	ap	vc	f	ap	vc	f	ap
	(mm)	(m/min)	(mm/tooth)	(mm)	(m/min)	(mm/tooth)	(mm)	(m/min)	(mm/tooth)	(mm)	(m/min)	(mm/tooth)	(mm)	(m/min)	(mm/tooth)	(mm)	(m/min)	(mm/tooth)	(mm)

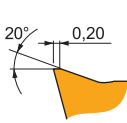

M geometry is versatile and the first choice for a wide range of working conditions. Designed with positive rake, medium T-land and rounding of cutting edge for medium machining.

SDMT 13T3AFSN-M	8215	–	■	245	0.30	3.0	☑	145	0.27	3.0	■	230	0.30	3.0	–	–	–	☑	60	0.24	2.4	■	45	0.21	1.0
	M6330	–	■	215	0.30	3.0	■	150	0.27	3.0	–	–	–	–	–	–	–	■	60	0.24	2.4	–	–	–	
	M8330	–	■	245	0.30	3.0	■	145	0.27	3.0	■	230	0.30	3.0	–	–	–	■	60	0.24	2.4	☑	45	0.21	1.0
	M8340	–	■	225	0.30	3.0	■	135	0.27	3.0	☑	210	0.30	3.0	–	–	–	–	55	0.24	2.4	–	–	–	
	M9325	–	■	295	0.30	3.0	–	–	–	–	■	280	0.30	3.0	–	–	–	–	–	–	–	☑	55	0.21	1.0
	M9340	–	■	265	0.30	3.0	■	155	0.27	3.0	–	–	–	–	–	–	–	■	65	0.24	2.4	–	–	–	

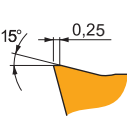

R geometry is strong and used for roughing and heavy working conditions. Designed with slightly positive rake, wide T-land and rounding of cutting edge for rough machining.

SDMT 13T3AFSN-R	M5315	–	☑	285	0.35	3.0	–	–	–	■	270	0.35	3.0	–	–	–	–	–	–	–	■	55	0.25	1.0	
	M8310	–	■	255	0.35	3.0	☑	130	0.32	3.0	■	240	0.35	3.0	–	–	–	–	–	–	■	50	0.25	1.0	
	M8330	–	■	240	0.35	3.0	☑	140	0.32	3.0	■	225	0.35	3.0	–	–	–	–	–	–	☑	45	0.25	1.0	
	M8340	–	■	220	0.35	3.0	☑	130	0.32	3.0	☑	205	0.35	3.0	–	–	–	–	–	–	–	–	–	–	
	M9325	–	■	280	0.35	3.0	–	–	–	–	■	265	0.35	3.0	–	–	–	–	–	–	–	☑	55	0.25	1.0

XDET 13



	IC	D1	S
	(mm)	(mm)	(mm)
13T3	13.385	4.40	3.97

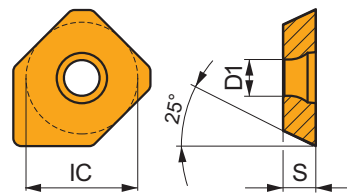

Suitability and starting values for cutting speed (vc), feed (f) and depth of cut (ap). Refer to our Machining Calculator app for further calculations.

Product	RE	P			M			K			N			S			H		
		vc	f	ap	vc	f	ap	vc	f	ap	vc	f	ap	vc	f	ap	vc	f	ap
	(mm)	(m/min)	(mm/tooth)	(mm)	(m/min)	(mm/tooth)	(mm)	(m/min)	(mm/tooth)	(mm)	(m/min)	(mm/tooth)	(mm)	(m/min)	(mm/tooth)	(mm)	(m/min)	(mm/tooth)	(mm)

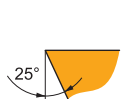

Wiper design for improved surface finish when machining with large cutters and high feed rates.

XDET 13T3AFER	8215	–	■	420	0.10	0.2	☑	250	0.09	0.2	■	395	0.10	0.2	–	–	–	–	–	–	–	–	–	–
	M8330	–	■	395	0.10	0.2	☑	235	0.09	0.2	■	375	0.10	0.2	–	–	–	–	–	–	–	–	–	–



a_s / DC	5%	10%	15%	20%	25%	30%	40%	50%	60%	70%	75%	80%	90%	100%
	1.48	1.35	1.27	1.22	1.19	1.16	1.11	1.08	1.05	1.03	1.00	1.00	1.00	1.00
	2.20	1.60	1.35	1.20	1.10	0.95	0.85	0.75	0.85	0.95	1.00	1.00	1.00	1.00
	0.64	0.64	0.64	0.64	0.64	0.65	0.65	0.67	0.68	0.71	0.72	0.74	0.79	1.00

	SDET 13-F	SDMT 13-M	SDMT 13-R	SDET 13-FA	XDET 13
	-	-	-	-	-
	1.75	1.75	1.75	1.75	8.19

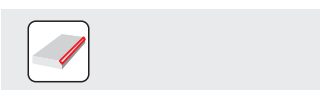
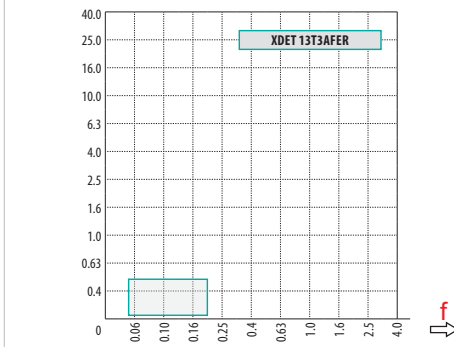
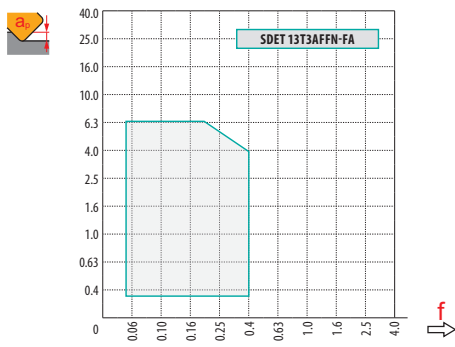
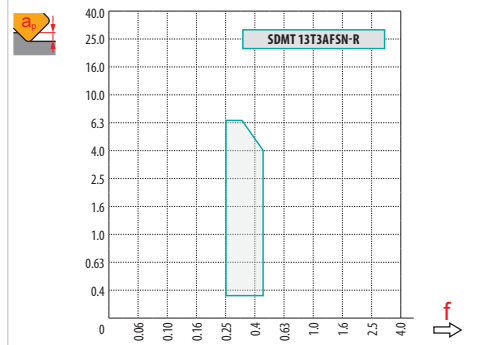
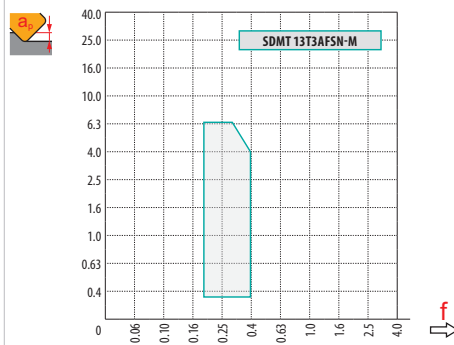
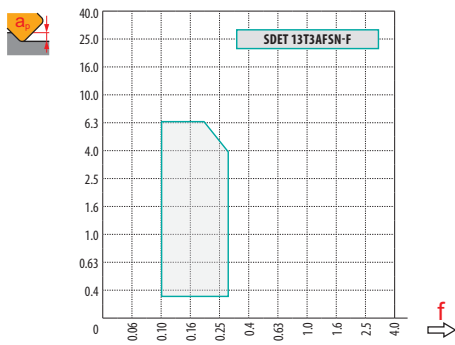

DC	X.V	f_{max}
32	1.22	0.15
40	1.26	0.16
50	1.30	0.18
63	1.34	0.20
80	1.39	0.22
100	1.43	0.24
125	1.48	0.26
160	1.53	0.29
200	1.58	0.33
250	1.63	0.36

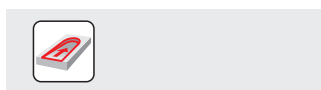

DC	RPMX	APMX/I
32	14.1°	6.4/27
40	11.8°	6.4/32
50	9.8°	6.4/39
63	7.7°	6.4/49
80	5.2°	6.4/72
100	4.1°	6.4/91
125	3.2°	5.45/100
160	1.0°	1.6/100
200	0.4°	0.55/100
250	0.3°	0.4/100

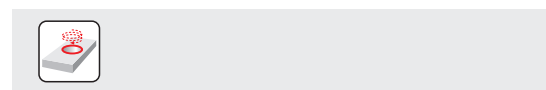

DC	DMIN	DMAX	$\frac{S_{MAX}}{D_{MIN}}$	$\frac{S_{MAX}}{D_{MAX}}$
32	60.0	89.8	1.7	1.7
40	75.0	107.0	1.7	1.7
50	94.0	127.0	1.7	1.7
63	120.0	152.8	1.7	1.7
80	155.0	186.8	1.7	1.7
100	193.0	225.8	1.7	1.7
125	245.0	275.6	1.7	1.7
160	322.0	345.6	1.7	1.7
200	405.0	425.6	1.7	1.7
250	505.0	525.6	1.7	1.7



1.5



SLN12X

PRODUCTIVE TANGENTIAL SHOULDER MILLING

INTRODUCTION



A new assortment of LNEX 12 negative tangential inserts, with four cutting edges, provides a highly productive solution for a wide range of applications. The Pramet LNEX 12 insert has been designed for square shoulder milling, with a maximum depth of cut up to 10 mm, offering stable clamping and a strong cutting edge. Its robust cutter body provides long tool life and excellent breakage resistance, while also reducing chatter.



LNEX-F

- Productive 4-edged ground insert
- Low carbon steels, soft stainless steels
- Light to medium cuts



LNEX-M

- Productive 4-edged ground insert
- Steels and cast irons, possibly hard steels
- Medium to rough cuts



MILLING CUTTERS AND INSERTS

INSERTS FEATURES & BENEFITS

Robust four-edged insert with two geometries M and F.



PRODUCTIVE SOLUTION

for a wide range of applications, with increased feed per tooth and depth of cut.

Positive rake angle on a tough tangential insert for low cutting forces.



SMOOTH CUTTING ACTION

reduced spindle load, excellent chip evacuation and process stability.

Peripherally ground and a highly precise square shoulder insert.



TRUE 90° CORNER

with improved wall accuracy and straightness.

Patented U-groove segment in corner geometry of insert for excellent chip forming.



IMPROVED CHIP EVACUATION

expands application range for low-power machines and small depths of cut.

Wide range of applications, with possibility for ramping, helical interpolation and plunge milling.



OPERATIONAL VERSATILITY

offering an economic solution.

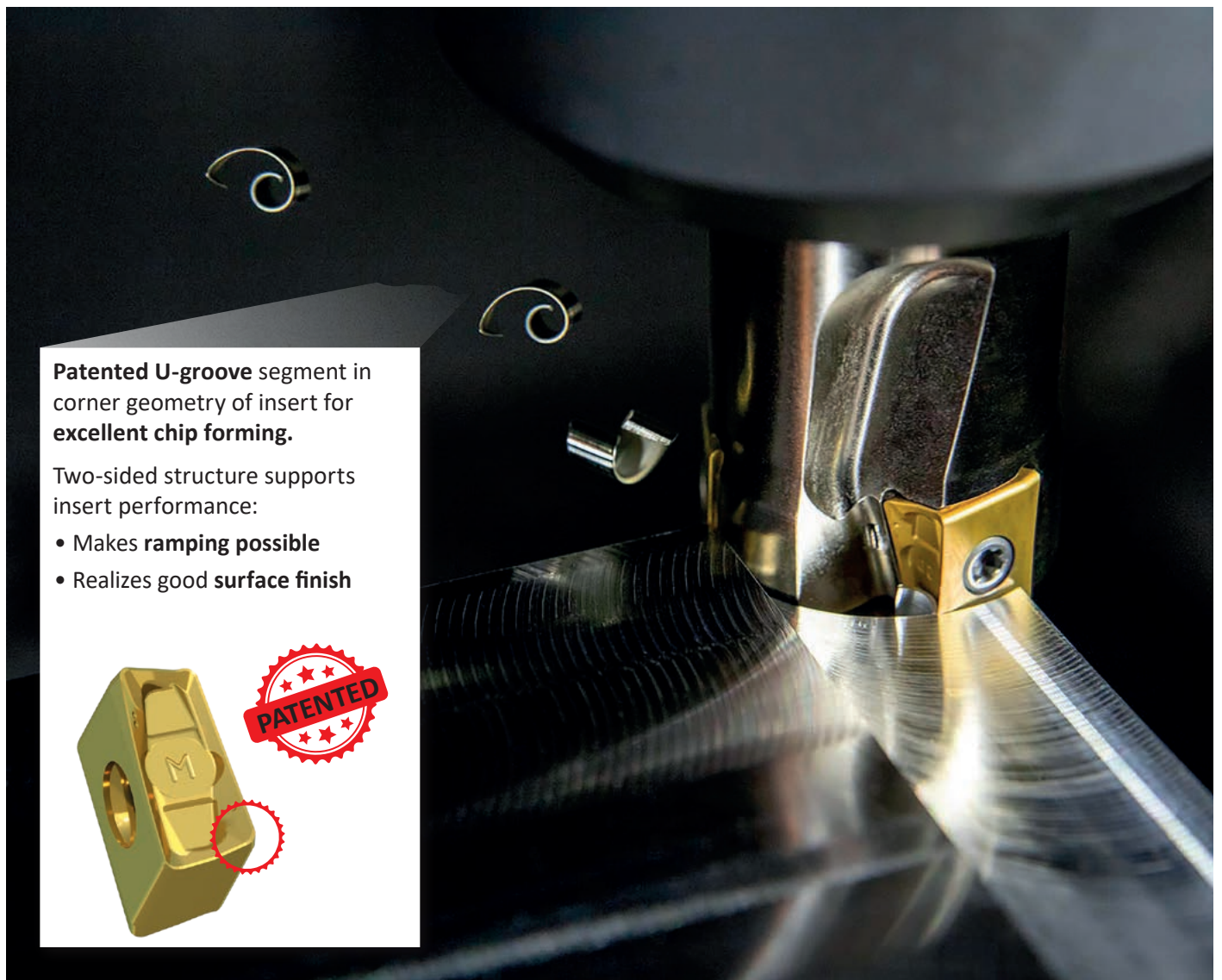

Patented U-groove segment in corner geometry of insert for **excellent chip forming**.

Two-sided structure supports insert performance:

- Makes **ramping possible**
- Realizes good **surface finish**





SLN12X

PRODUCTIVE TANGENTIAL SHOULDER MILLING

CUTTERS SLN12X – FEATURES & BENEFITS

Improved body strength and thick cutter core for enhanced rigidity.



RELIABLE CUTTING PROCESS

with low vibrations and long tool life for both insert and cutter.

Easily accessible large clamping screws.



SIMPLE INDEXING

and handling of insert.



SLN12X

- Cylindrical shank
- DC range
25 – 40 mm
1.00 – 1.50 inch



SLN12X

- Weldon shank
- DC range
25 – 40 mm
1.00 – 1.50 inch



SLN12X

- Shell body
- DC range
40 – 125 mm
1.50 – 5.00 inch



MILLING CUTTERS AND INSERTS

SHOULDER MILLING EXAMPLES

Workpiece: Structural steel forging – Door hinge (220 HB)
 Material: 1.0553 / 345A / S355JO
 Cutter: 50A05R-S90LN12X-C
 Coolant: Soluble oil emulsion (~ 8%)

Cutting conditions				
v_c (m/min)	f_z (mm)	a_p (mm)	a_e (mm)	TOH (mm)
212	0.09	7	30	58
Insert geometry		Tool life (pcs)		
LNEX 121008SR-F:M8340		2200		

Geometry F is very effective, lowest power consumption.
 Perfect surface finishing, better than all the competitors.
 Stable cutting edge wear, very homogeneous flank wear.
 No burrs all along the tool life => possible to skip deburring.



WMG P2.1

Workpiece: Carbon steel plate (220 HB)
 Material: 1.1186 / 1040 / C40
 Cutter: 50A05R-S90LN12X-C
 Coolant: No

Cutting conditions				
v_c (m/min)	f_z (mm)	a_p (mm)	a_e (mm)	TOH (mm)
113	0.18	5	3.5	138
118	0.28	3	30	84
Insert geometry		Tool life (min)		
LNEX 121008SR-F:M8340		48+		

Excellent surface quality in roughing contouring operations.
 Good accuracy of 90° wall even with overhang of 138 mm.
 No vibrations with overhang of 85 mm and $f_z = 0.28$ mm.
 Perfect chip evacuation. After 48 min no evident wear.

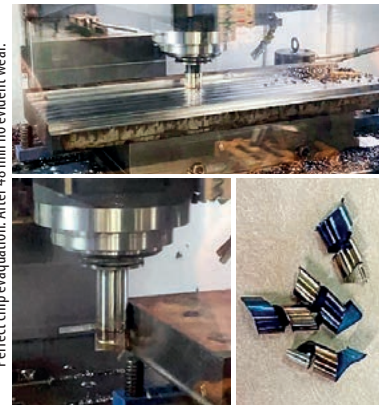

WMG P2.2

Workpiece: Carbon steel forging – Axle yoke (~ 210 HB)
 Material: EN8D / 1045 / CK45
 Cutter: 32A3R042B32-SLN12X-C
 Coolant: Soluble oil emulsion (~ 6%)

Cutting conditions				
v_c (m/min)	f_z (mm)	a_p (mm)	a_e (mm)	TOH (mm)
221	0.23	10	10	61
Insert geometry		Tool life (pcs)		
LNEX 121008SR-M:M8310		127		

Cycle time reduction with LNEX12-M is 48 %.
 Tool life improvement with LNEX12-M is 59 %.
 We observe only little wear after 18 min in cut.



WMG P2.3

Workpiece: Stainless steel forging – 3-way valve (~ 190 HB)
 Material: 1.4401 / 316 / X5CrNiMo17-12-2
 Cutter: 25A2R042B25-SLN12X-C
 Coolant: No

Cutting conditions				
v_c (m/min)	f_z (mm)	a_p (mm)	a_e (mm)	TOH (mm)
100	0.2	3	6	45
Insert geometry		Tool life (min)		
LNEX 121008SR-F:M8340		82		

Cycle time reduction with LNEX12-F is 20 %.
 Tool life improvement with LNEX12-F is 30 %.
 Only slight flank wear after 16 min in cut.



WMG M3.1



SLN12X



PRAMET

S



PRODN12 90° Tangential Square Shoulder Mill with Internal Coolant

Highly productive 90° shoulder mills utilising tangential LNEX 12 insert with 4 cutting edges and APMX of 10 mm. Suited for a wide range of applications. Available in cylindrical, weldon and arbor style. Robust cutter body supports long tool life and excellent breakage resistance.

KAPR	90°
APMX	10.0 mm

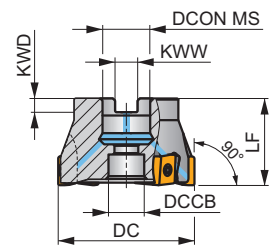
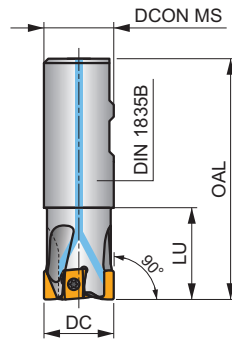
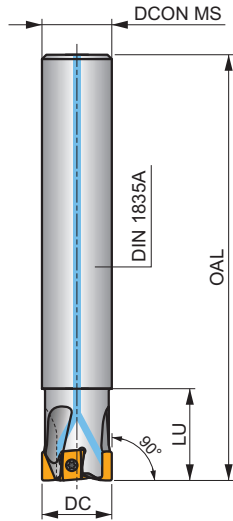
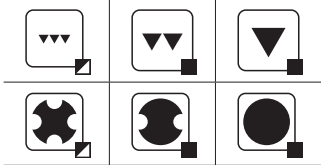
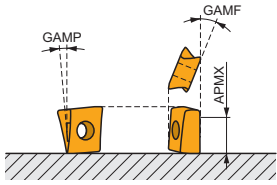

	0.06 – 0.20 mm
	0.06 – 0.18 mm



Product	DC	OAL	DCON MS	DCCB	LU	LF	KWW	KWD	GAMF	GAMP							
	(mm)	(mm)	(mm)	(mm)	(mm)	(mm)	(mm)	(mm)	(°)	(°)							
25A2R042A25-SLN12X-C	25	170	25	-	42	-	-	-	-30	-5	2	-	17300	✓	0.55	G1206	C0382
25A2R080A25-SLN12X-C	25	170	25	-	80	-	-	-	-30	-5	2	-	17300	✓	0.50	G1206	C0382
32A3R042A32-SLN12X-C	32	195	32	-	42	-	-	-	-22.5	-5	3	-	15300	✓	1.01	G1206	SQ340
32A3R090A32-SLN12X-C	32	195	32	-	90	-	-	-	-22.5	-5	3	-	15300	✓	0.99	G1206	SQ340
40A4R050A32-SLN12X-C	40	195	32	-	50	-	-	-	-22.5	-5	4	-	13700	✓	1.17	G1206	SQ340
25A2R042B25-SLN12X-C	25	100	25	-	42	-	-	-	-30	-5	2	-	17300	✓	0.29	G1206	C0382
32A3R042B32-SLN12X-C	32	110	32	-	42	-	-	-	-22.5	-5	3	-	15300	✓	0.55	G1206	SQ340
40A4R050B32-SLN12X-C	40	120	32	-	50	-	-	-	-22.5	-5	4	-	13700	✓	0.73	G1206	SQ340
40A03R-S90LN12X-C	40	-	16	12.4	-	40	8.4	5.6	-22.5	-5	3	-	13700	✓	0.15	G1206	SQ345
40A04R-S90LN12X-C	40	-	16	12.4	-	40	8.4	5.6	-22.5	-5	4	✓	13700	✓	0.23	G1206	SQ345
50A05R-S90LN12X-C	50	-	22	16.5	-	40	10.4	6.3	-19.5	-5	5	-	12300	✓	0.34	G1206	SQ343
50A06R-S90LN12X-C	50	-	22	16.5	-	40	10.4	6.3	-19.5	-5	6	-	12300	✓	0.34	G1206	SQ343
52A05R-S90LN12X-C	52	-	22	16.5	-	40	10.4	6.3	-19.5	-5	5	-	12300	✓	0.37	G1206	SQ343
63A06R-S90LN12X-C	63	-	22	16.5	-	40	10.4	6.3	-19.5	-5	6	✓	10900	✓	0.52	G1206	SQ343
63A08R-S90LN12X-C	63	-	22	16.5	-	40	10.4	6.3	-19.5	-5	8	-	10900	✓	0.50	G1206	SQ343
66A06R-S90LN12X-C	66	-	22	16.5	-	40	10.4	6.3	-19.5	-5	6	✓	10900	✓	0.54	G1206	SQ343
80A07R-S90LN12X-C	80	-	27	38.1	-	50	12.4	7	-19.5	-5	7	✓	9700	✓	1.00	G1206	SQ341
80A10R-S90LN12X-C	80	-	27	38.1	-	50	12.4	7	-19.5	-5	10	-	9700	✓	0.98	G1206	SQ341
100A08R-S90LN12X-C	100	-	32	45.1	-	50	14.4	8	-17.5	-5	8	✓	8700	✓	1.91	G1206	SQ341
100A11R-S90LN12X-C	100	-	32	45.1	-	50	14.4	8	-17.5	-5	11	-	8700	✓	1.88	G1206	SQ341
125A12R-S90LN12X-C	125	-	40	56.1	-	63	16.4	9	-17.5	-5	12	✓	7800	✓	3.39	G1206	SQ341

	G1206		LNEX 1210..
--	-------	--	-------------



Icon 1	Icon 2	Icon 3	Icon 4	Icon 5	Icon 6	Icon 7	Icon 8	Icon 9
C0382	US 44010-T15P	3.5	M 4	10	-	-	Flag T15P	-
SQ340	US 44012-T15P	3.5	M 4	12	-	-	Flag T15P	-
SQ341	US 44012-T15P	3.5	M 4	12	D-T08P/T15P	FG-15	-	-
SQ343	US 44012-T15P	3.5	M 4	12	D-T08P/T15P	FG-15	-	HS 1030C
SQ345	US 44012-T15P	3.5	M 4	12	D-T08P/T15P	FG-15	-	HS 90835

LNEX 12



Icon	W1	D1	L	S
	(mm)	(mm)	(mm)	(mm)
1210	6.000	4.40	13.30	10.26

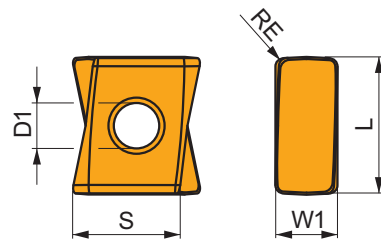

Suitability and starting values for cutting speed (vc), feed (f) and depth of cut (ap). Refer to our Machining Calculator app for further calculations.

Product	RE (mm)	P			M			K			N			S			H		
		vc (m/min)	f (mm/tooth)	ap (mm)	vc (m/min)	f (mm/tooth)	ap (mm)	vc (m/min)	f (mm/tooth)	ap (mm)	vc (m/min)	f (mm/tooth)	ap (mm)	vc (m/min)	f (mm/tooth)	ap (mm)	vc (m/min)	f (mm/tooth)	ap (mm)

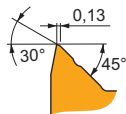

F geometry is sharp and used for light and medium machining, suitable for large overhang applications. Designed with highly positive rake, narrow T-land and rounding of cutting edge for light to medium machining.

LNEX 121008SR-F	M6330	0.8	220	0.17	3.0	155	0.15	3.0	-	-	-	-	-	-	-	-	-	-	-
	M8310	0.8	280	0.17	3.0	140	0.15	3.0	265	0.17	3.0	-	-	-	55	0.11	1.0	-	-
	M8330	0.8	260	0.17	3.0	155	0.15	3.0	245	0.17	3.0	-	-	-	50	0.11	1.0	-	-
	M8340	0.8	235	0.17	3.0	140	0.15	3.0	220	0.17	3.0	-	-	-	-	-	-	-	-
LNEX 121012SR-F	M6330	1.2	230	0.17	3.0	165	0.15	3.0	-	-	-	-	-	-	-	-	-	-	-
	M8310	1.2	295	0.17	3.0	150	0.15	3.0	280	0.17	3.0	-	-	-	55	0.11	1.0	-	-
	M8330	1.2	270	0.17	3.0	160	0.15	3.0	255	0.17	3.0	-	-	-	50	0.11	1.0	-	-

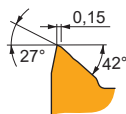

M geometry is versatile and the first choice for a wide range of working conditions. Designed with positive rake, medium T-land and rounding of cutting edge for medium up to semi-roughing machining.

LNEX 121008SR-M	M6330	0.8	210	0.20	3.5	-	-	-	-	-	-	-	-	-	-	-	-	-	-
	M8310	0.8	265	0.20	3.5	-	-	-	250	0.20	3.5	-	-	-	50	0.16	1.0	-	-
	M8330	0.8	245	0.20	3.5	-	-	-	230	0.20	3.5	-	-	-	45	0.16	1.0	-	-
	M8340	0.8	220	0.20	3.5	-	-	-	205	0.20	3.5	-	-	-	-	-	-	-	-
	M9315	0.8	320	0.20	3.5	-	-	-	300	0.20	3.5	-	-	-	60	0.16	1.0	-	-
	M9325	0.8	300	0.20	3.5	-	-	-	285	0.20	3.5	-	-	-	60	0.16	1.0	-	-
LNEX 121012SR-M	M8310	1.2	280	0.20	3.5	-	-	-	265	0.20	3.5	-	-	-	55	0.16	1.0	-	-
	M8330	1.2	255	0.20	3.5	-	-	-	240	0.20	3.5	-	-	-	50	0.16	1.0	-	-
	M8340	1.2	235	0.20	3.5	-	-	-	220	0.20	3.5	-	-	-	-	-	-	-	-
LNEX 121016SR-M	M8310	1.6	295	0.20	3.5	-	-	-	280	0.20	3.5	-	-	-	55	0.16	1.0	-	-
	M8330	1.6	270	0.20	3.5	-	-	-	255	0.20	3.5	-	-	-	50	0.16	1.0	-	-
	M8340	1.6	245	0.20	3.5	-	-	-	230	0.20	3.5	-	-	-	-	-	-	-	-
LNEX 121020SR-M	M8330	2.0	285	0.20	3.5	-	-	-	270	0.20	3.5	-	-	-	55	0.16	1.0	-	-
	M8340	2.0	255	0.20	3.5	-	-	-	240	0.20	3.5	-	-	-	-	-	-	-	-
LNEX 121024SR-M	M8330	2.4	285	0.20	3.5	-	-	-	270	0.20	3.5	-	-	-	55	0.16	1.0	-	-
	M8340	2.4	255	0.20	3.5	-	-	-	240	0.20	3.5	-	-	-	-	-	-	-	-



a_e / DC	5 %	10 %	15 %	20 %	25 %	30 %	40 %	50 %	60 %	70 %	75 %	80 %	90 %	100 %
	1.48	1.35	1.27	1.22	1.19	1.16	1.11	1.08	1.05	1.03	1.00	1.00	1.00	1.00
	2.20	1.60	1.35	1.20	1.10	0.95	0.85	0.75	0.85	0.95	1.00	1.00	1.00	1.00
	0.64	0.64	0.64	0.64	0.64	0.65	0.65	0.67	0.68	0.71	0.72	0.74	0.79	1.00

	LNEX 12-F		LNEX 12-M				
	0.8	1.2	0.8	1.2	1.6	2.0	2.4
	2.25	1.73	2.25	1.73	1.33	1.15	0.79

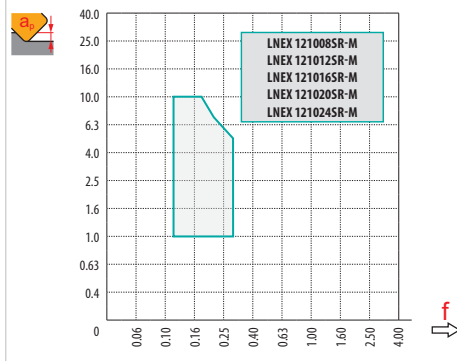
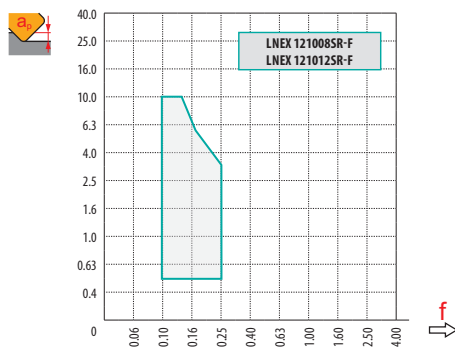



	2.5



	2.0	3.0	4.0	5.0
	0.30	0.20	0.20	0.15

	RPMX	APMX/I
25	0.80°	1.40/100
32	0.60°	1.00/100
40	0.35°	0.60/100
50	0.30°	0.50/100
52	0.30°	0.50/100
63	0.20°	0.35/100

	DMIN	DMAX		
25	44.0	48.0	0.6	0.7
32	58.0	62.0	0.8	1.0
40	74.0	78.0	0.7	0.8
50	94.0	98.0	0.7	0.8
52	98.0	102.0	0.7	0.8
63	120.0	124.0	0.3	0.4



		3	5	10	15	20	30	40	50	60	80	100
25		0.548	0.707	1.000	1.225	1.414	1.732	2.000	2.236	2.449	2.828	3.162
32		0.620	0.800	1.131	1.386	1.600	1.960	2.263	2.530	2.771	3.200	3.578
40		0.693	0.894	1.265	1.549	1.789	2.191	2.530	2.828	3.098	3.578	4.000
50		0.775	1.000	1.414	1.732	2.000	2.449	2.828	3.162	3.464	4.000	4.472
52		0.869	1.122	1.587	1.944	2.245	2.750	3.175	3.550	3.888	4.490	5.020
63		0.980	1.265	1.789	2.191	2.530	3.098	3.578	4.000	4.382	5.060	5.657

		3	5	10	15	20	30	40	50	60	80	100
0.8		0.155	0.200	0.283	0.346	0.400	0.490	0.566	0.632	0.693	0.800	0.894
1.2		0.170	0.219	0.310	0.379	0.438	0.537	0.620	0.693	0.759	0.876	0.980
1.6		0.196	0.253	0.358	0.438	0.506	0.620	0.716	0.800	0.876	1.012	1.131
2.0		0.219	0.283	0.400	0.490	0.566	0.693	0.800	0.894	0.980	1.131	1.265
2.4		0.245	0.316	0.447	0.548	0.632	0.775	0.894	1.000	1.095	1.265	1.414





SNGX 11

STRONG HIGH FEED GEOMETRY – HM

INTRODUCTION



A new strong HM geometry has been launched to support the current Pramet high feed SSN11 cutters and SNGX 11 inserts. The geometry is specifically for hard steel and cast iron. It is the latest addition to the economical double-sided SNGX inserts, which have eight cutting edges.

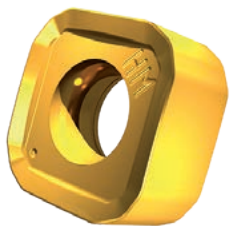

SNGX-HM

- 8-edged HFC insert
- Hard steels, cast irons
- Medium and rough cuts



MILLING CUTTERS AND INSERTS

FEATURES & BENEFITS

Material specific strong geometry.



FOR HARD STEELS AND CAST IRONS

extending application range of SSN11 cutter family.

Highly negative T-land providing cutting-edge protection, improving durability and process security.



PROLONGED TOOL LIFE

by up to 50 % compared to previous assortment.

Positive rake and narrow T-land for reduced cutting forces.



IMPROVED PROCESS STABILITY

with lower spindle load, reduced vibrations and smoother cutting action.

Balanced ratio of sharpness and edge protection.



VERSATILE OPTION

for high feed milling as suitable for machines with less-torque and rigidity.

HFC FACE MILLING EXAMPLES

Workpiece: Tool steel Die (310 HB)
Material: 1.2343 / H11 / SKD6
Cutter: 50A05R-SMOSN11-C
Coolant: No

Cutting conditions				
v_c (m/min)	f_z (mm)	a_p (mm)	a_e (mm)	TOH (mm)
150	1.2	1.5	33	62
Insert geometry comparison		Tool life (min)		
SNGX 110416SR-	M:M8310	78		
	HM:M8310	105		

SNGX 110416SR-HM:M8310, 105 min

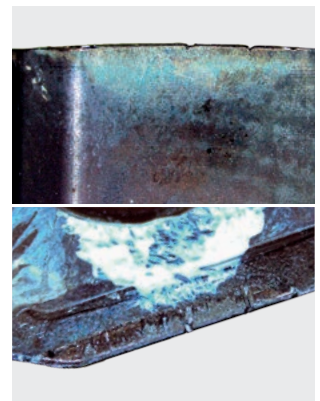

WMG P4.2

Workpiece: Cast iron plate (210 HB)
Material: GG25 / FC250
Cutter: 50A05R-SMOSN11-C
Coolant: No

Cutting conditions				
v_c (m/min)	f_z (mm)	a_p (mm)	a_e (mm)	TOH (mm)
180	1	1	33	62
Insert geometry comparison		Tool life (min)		
SNGX 110416SR-	M:M8330	27		
	HM:M8330	42		

SNGX 110416SR-HM:M8330, 42 min

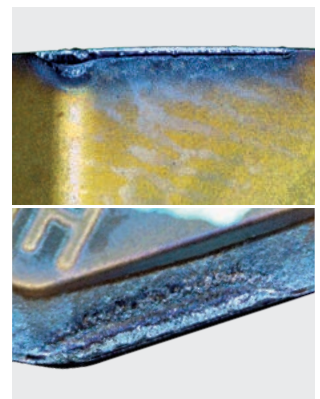

WMG K1.2

v_c = cutting speed, f_z = feed per tooth, a_p = axial depth of cut, a_e = radial depth of cut, TOH = tool overhang



SBN10

ADDITIONAL SHELL MILL CUTTERS

INTRODUCTION



Several new shell mill cutters have been added to the SBN10 high feed milling range. The latest update includes cutter diameters starting from 50 up to 66 mm with two variants of tooth density. All the new cutters have different setting angles of insert seating, resulting in ideal chip evacuation when using BNGX 10 inserts for productive HFC milling.

 **PRAMET**

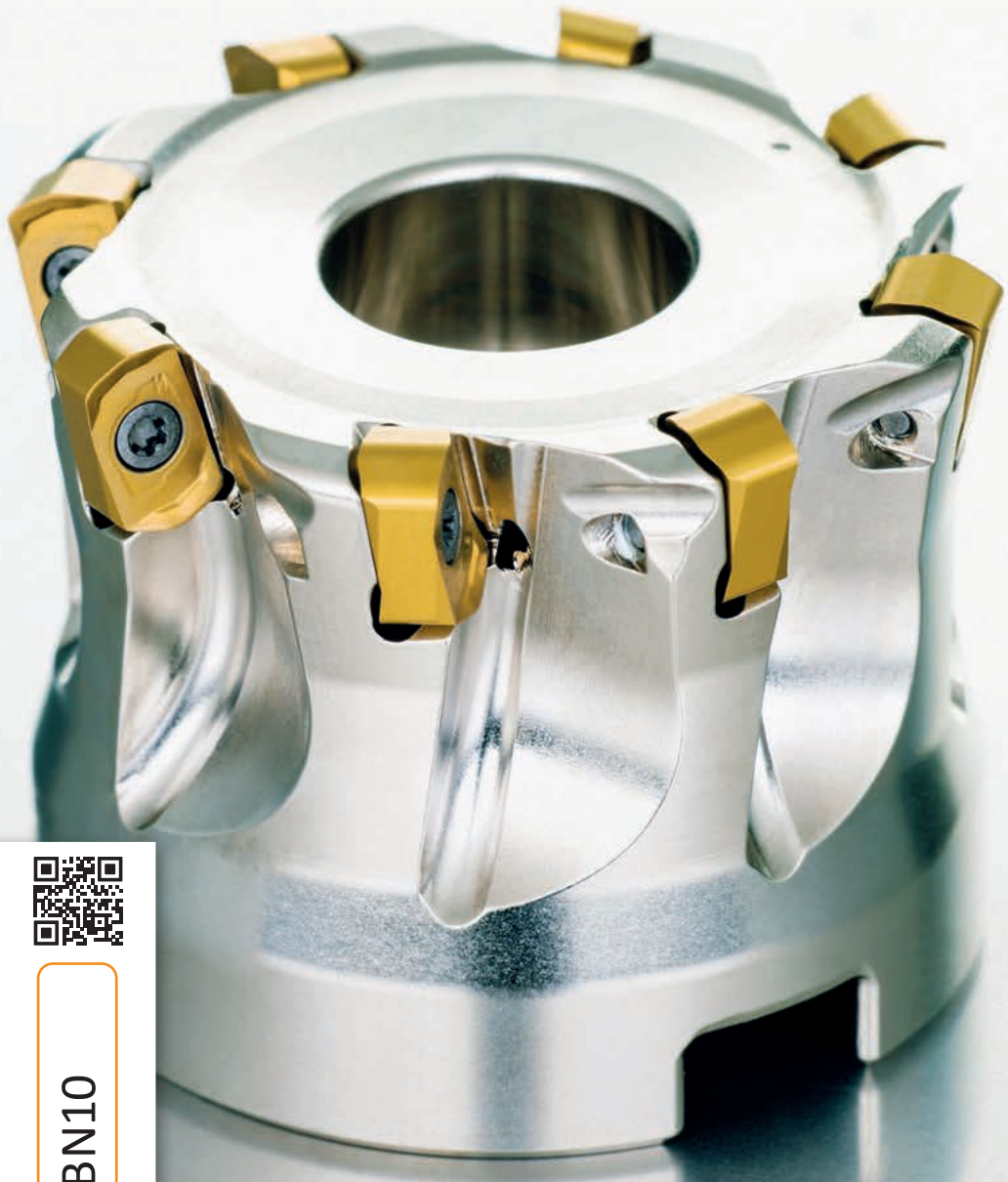

SBN10

- Shell body
- DC range newly:
40 – 66 mm
1.50 – 2.00 inch



SHELL MILLS SBN10 – FEATURES & BENEFITS

Cutter body made of high quality, nickelized tool steel.



HIGH DURABILITY
of hardened cutter body.

Different setting angles on new shell mills prevent over-cutting of chips.



LONG INSERT TOOL LIFE
due to ideal chip evacuation.

Shell type cutters available in larger diameters and various tooth pitches.



COMPETITIVE RANGE
of all SBN10 cutters for broader usage.

New setting angles prevent chips over-cutting.

New cutters with $KAPR = 29^\circ$ are compatible with all BNGX 10 inserts, but not with ANHX 10.



BNGX-M

- 4-edged HFC insert
- Steels, cast irons
- Medium cuts



BNGX-MM

- 4-edged HFC insert
- Stainless steels, HRSA
- Light cuts



BNGX-HM

- 4-edged HFC insert
- Cast irons, hard steels
- Heavy cuts



SWN04C

HIGH PRECISION CUTTERS REVAMPED

INTRODUCTION



A major upgrade of all SWN04C cutter bodies. These modular cutters have a new design of clamping cylinder (DCON MS), which has a very steep cone with a natural self-centering capability. Also, all SWN04C cutters are now blackened instead of nickelized, reducing tolerances of insert clamping and indexing. Both upgrades result in high precision clamping and reduced radial run-out to almost zero, while still remaining compatible with common modular holders!



SWN04C

- Modular head
- DC range:
16 – 35 mm



SWN04C

- Cylindrical shank
- DC range:
16 – 32 mm



MODULAR CUTTERS SWN04C – FEATURES & BENEFITS

New clamping design with self-centering capability, still compatible with common modular holders!



HIGH PRECISION CLAMPING
of all modular cutters.

Blackening instead of nickelizing makes all tolerances even tighter.



IMPROVED RADIAL RUNOUT
within just a few microns.

Cutter body made of high quality, blackened tool steel.



HIGH DURABILITY
of hardened cutter body.

Blackened cutter body for higher precision of seating place and modular connection.

Specific precision grinded cone shape clamping with self-centering capability.

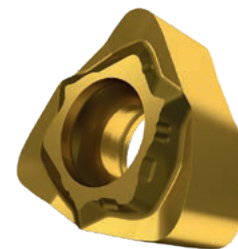
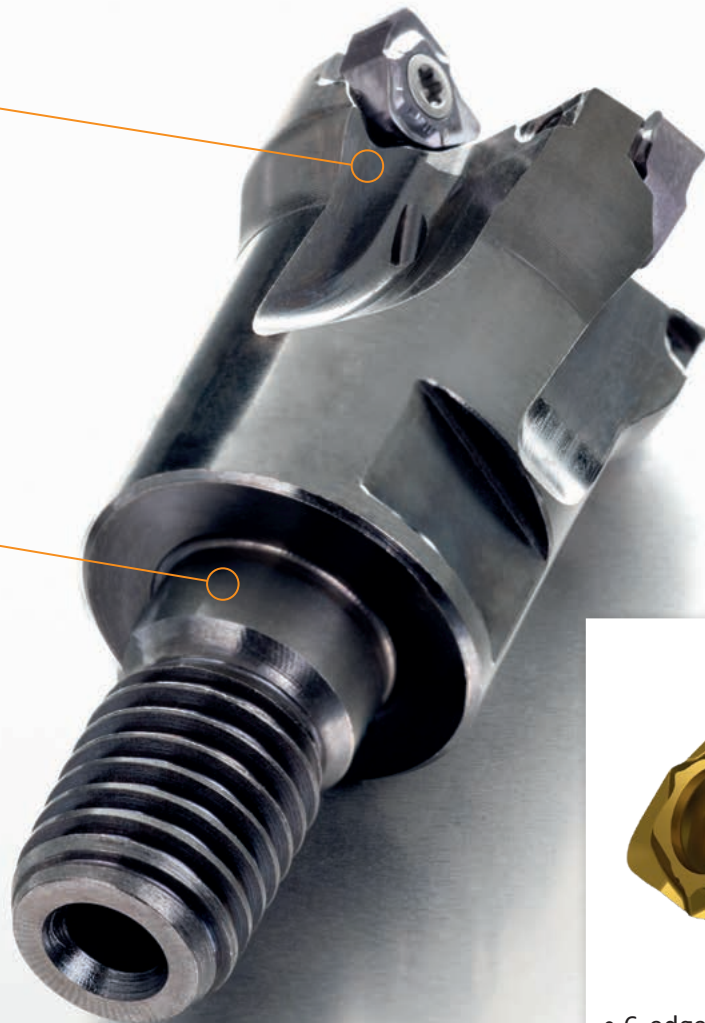

WNHX

- 6-edged finishing insert
- Hard steels, cast irons, steels and cast steels
- Finishing wall and face with long overhang



DORMER PRAMET



ALL TOOLS TOGETHER

Our entire assortment of rounds tools and indexables is included within the machining calculator app. That's more than **40.000** items! Whatever your machining we're likely to have something for it.
Simply Reliable.

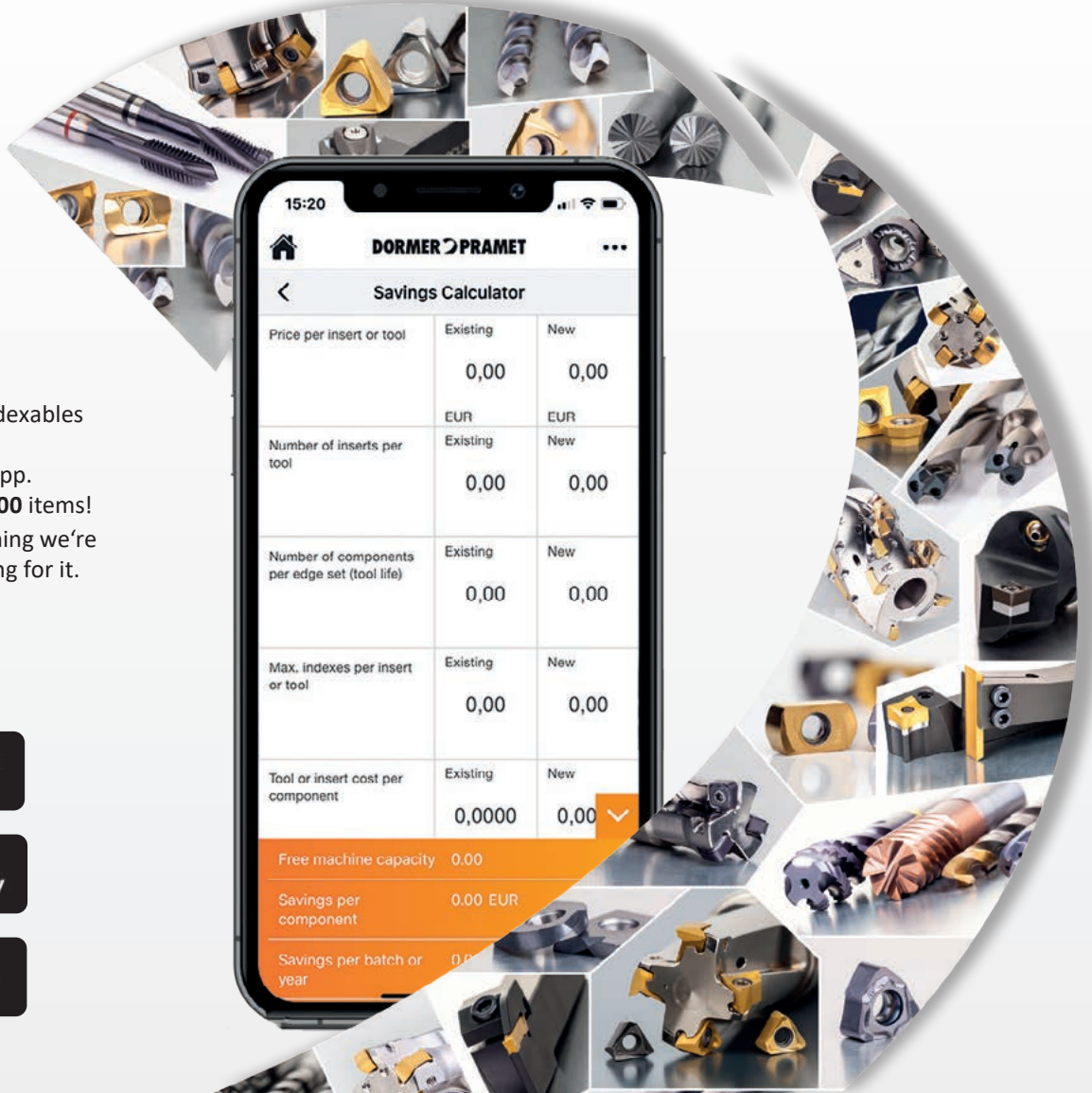

DORMER PRAMET		
Savings Calculator		
Price per insert or tool	Existing 0,00	New 0,00
	EUR	EUR
Number of inserts per tool	Existing 0,00	New 0,00
Number of components per edge set (tool life)	Existing 0,00	New 0,00
Max. indexes per insert or tool	Existing 0,00	New 0,00
Tool or insert cost per component	Existing 0,0000	New 0,00
Free machine capacity	0,00	
Savings per component	0,00 EUR	
Savings per batch or year	0,00	

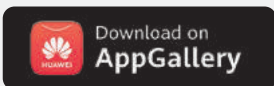











TECHNICAL INFORMATION



CORRECTION FACTORS – TURNING

Correction factors for specific type of operation C_{VcO}

  															
	0.5			1.5			2.5			5.0			12.0		
	I	II	III	I	II	III	I	II	III	I	II	III	I	II	III
	0.05	0.08	0.10	0.10	0.15	0.20	0.20	0.30	0.40	0.40	0.60	0.80	0.80	1.00	1.30
Chip-breakers for fine finishing (FF, FF2...)	1.15	1.00	0.95	0.85	0.80	–	–	–	–	–	–	–	–	–	–
Chip-breakers for finishing (NF, SF...)	–	–	1.20	1.05	1.00	1.05	1.00	0.90	–	–	–	–	–	–	–
Chip-breakers for medium machining (FM, M, NM, NMR, SM...)	–	–	–	–	–	1.15	1.10	1.00	0.95	0.85	–	–	–	–	–
Chip-breakers for roughing (RM, NRM, NR, R...)	–	–	–	–	–	–	–	–	1.25	1.10	1.00	0.95	0.65	–	–
Chip-breakers for heavy roughing (HR, HR2, NR2, OR...) for 45 min durability	–	–	–	–	–	–	–	–	–	1.25	1.20	1.15	1.05	1.00	0.95

Correction factors for required durability C_{VcT}

	minutes	10	15	20	30	45	60
General machining operations (fine finishing up to roughing)		1.13	1.00	0.93	0.84	0.76	0.71
Heavy machining operations (heavy roughing)		–	–	–	1.10	1.00	0.93

Additional correction factors C_{VcA}

Machining environment	C_{VcA}
Condition of the work-material (hard skin due to forging or casting)	0.70
Internal turning	0.75
Parting and grooving (radial)	0.88
Face grooving	0.80
Interrupted cut	0.80
Unstable machining conditions	0.85
Common machining conditions	1.00
Stable machining conditions	1.20

Resulting corrected cutting speed v_{cc}

$$v_{cc} = v_c \times k_{VG} \times C_{VcO} \times C_{VcT} \times C_{VcA}$$





v_c – starting speed from catalogue page

k_{VG} – coefficient of used material



CORRECTION FACTORS – INDEXABLE MILLS

Correction factors for specific type of cutter and operation C_{VCO}

			
Face mills with <i>KAPR</i> 45° – 60° and negative inserts (SHN06C, SHN09C, CHN09, ...)	1.15	1.00	0.85
Face mills with <i>KAPR</i> 45° and positive inserts (SOE06Z, SOE09Z, SOD05, ...)	1.15	1.00	0.85
Shoulder mills with <i>KAPR</i> 90° (SAD07D, SAD11E, SAD16E, SLN12, SLN16..)	1.10	1.00	0.90
Copy face mills (SRC10 – SRC20, SRD05 – SRD16, ...)	1.10	1.00	0.90
Copy end mills (K2-PPH, K2-SLC, K2-SRC, K3-CXP...)	1.10	1.00	0.90
Disc mills (S90CN(XN), S90SN...)	1.10	1.00	0.90
Shoulder mills with extended flute J(T)-CSD12X, J(T)-SAD11E, J(T)-SAD16E...)	1.25	1.00	0.80
Face mills for heavy duty (FSB22X, SPN13..)	1.30	1.00	0.85
Shoulder mills for heavy duty (FTB27X..)	1.25	1.00	0.85

Correction factors for required durability C_{VCT}

	minutes	15	20	30	45	60	90	120
General machining operations (fine finishing up to roughing)	1.23	1.13	1.00	0.89	0.81	0.72	–	–
Heavy machining operations (heavy roughing)	–	–	1.23	1.13	1.00	0.89	0.81	–

Additional correction factors C_{VCA}

Machining environment	C_{VCA}
Condition of the work-material (hard skin due to forging or casting)	0.70
Unstable machining conditions	0.85
Common machining conditions	1.00
Stable machining conditions	1.20

Correction factors for cutting speed when face and shoulder milling with < 100 % radial immersion C_{VCRCT}

$\frac{a_p}{DC}$	5 %	10 %	15 %	20 %	25 %	30 %	40 %	50 %	60 %	70 %	75 %	80 %	90 %	100 %
	1.48	1.35	1.27	1.22	1.19	1.16	1.11	1.08	1.05	1.03	1.00	1.00	1.00	1.00

Resulting corrected cutting speed v_{CC}

$$v_{CC} = v_c \times k_{VG} \times C_{VCO} \times C_{VCT} \times C_{VCA} \times C_{fzRCT}$$

v_c – starting speed from catalogue page

k_{VG} – coefficient of used material



WMG (WORK MATERIAL GROUP)

ISO group	WMG (Work Material Group)	Hardness (HB or HRC)	Ultimate Tensile Strength (MPa)	Correction factor kvG			
P	P1	P1.1	Sulfurized	< 240 HB	≤ 830	1.33	
		P1.2	Free machining steel	Sulfurized and phosphorized	< 180 HB	≤ 620	1.49
		P1.3	(carbon steels with increased machinability)	Sulfurized/phosphorized and leaded	< 180 HB	≤ 620	1.53
	P2	P2.1	Plain carbon steel (steels comprised of mainly iron and carbon)	Containing < 0.25 % C	< 180 HB	≤ 620	1.14
		P2.2		Containing < 0.55 % C	< 240 HB	≤ 830	1.00
		P2.3		Containing > 0.55 % C	< 300 HB	≤ 1030	0.89
	P3	P3.1	Alloy steel (carbon steels with an alloying content ≤ 10 %)	Annealed	< 180 HB	≤ 620	0.92
		P3.2		Hardened and tempered	180 – 260 HB	> 620 ≤ 900	0.74
		P3.3			260 – 360 HB	> 900 ≤ 1240	0.63
	P4	P4.1	Tool steel (special alloy steel for tools, dies and molds)	Annealed	< 26 HRC	≤ 900	0.55
P4.2		Hardened and tempered		26 – 39 HRC	> 900 ≤ 1240	0.47	
P4.3				39 – 45 HRC	> 1240 ≤ 1450	0.38	
M	M1	Ferritic stainless steel (straight chromium non-hardenable alloys)	Annealed	< 160 HB	≤ 520	1.22	
				160 – 220 HB	> 520 ≤ 700	1.03	
	M2	Martensitic stainless steel (straight chromium hardenable alloys)	Quenched and tempered	< 200 HB	≤ 670	1.08	
				200 – 280 HB	> 670 ≤ 950	0.89	
				280 – 380 HB	> 950 ≤ 1300	0.75	
	M3	Austenitic stainless steel (chromium-nickel and chromium-nickel-manganese alloys)	Precipitation-hardened	< 200 HB	≤ 750	1.00	
				200 – 260 HB	> 750 ≤ 870	0.86	
				260 – 300 HB	> 870 ≤ 1040	0.77	
	M4	M4.1	Austenitic-ferritic (DUPLEX) or super-austenitic stainless steel		< 300 HB	≤ 990	0.75
		M4.2	Precipitation hardening austenitic stainless steel		300 – 380 HB	≤ 1320	0.64
K	K1	Gray iron or Automotive Gray iron (GG) (iron-carbon castings with a lamellar graphite microstructure)	Ferritic or ferritic-pearlitic	< 180 HB	≤ 190	1.35	
			Ferritic-pearlitic or pearlitic	180 – 240 HB	> 190 ≤ 310	1.00	
			Pearlitic	240 – 280 HB	> 310 ≤ 390	0.75	
	K2	Malleable iron (GTS/GTW) (iron-carbon castings with a graphite-free microstructure)	Ferritic	< 160 HB	≤ 400	1.39	
			Ferritic or pearlitic	160 – 200 HB	> 400 ≤ 550	1.13	
			Pearlitic	200 – 240 HB	> 550 ≤ 660	0.90	
	K3	Ductile iron (GGG) (iron-carbon castings with a nodular graphite microstructure)	Ferritic	< 180 HB	≤ 560	1.23	
			Ferritic or pearlitic	180 – 220 HB	> 560 ≤ 680	0.94	
			Pearlitic	220 – 260 HB	> 680 ≤ 800	0.76	
	K4	K4.1	Austenitic gray iron (ASTM A436) (iron-carbon alloy castings with an austenitic lamellar graphite microstructure)		< 180 HB	≤ 190	1.14
					< 240 HB	≤ 740	0.86
		K4.2	Austenitic ductile iron (ASTM A439 or ASTM A571) (iron-carbon alloy castings with an austenitic nodular graphite microstructure)		< 280 HB	> 840 ≤ 980	0.63
					280 – 320 HB	> 980 ≤ 1130	0.54
					320 – 360 HB	> 1130 ≤ 1280	0.45
	K5	K4.3	Austempered ductile iron (ASTM A897) (iron-carbon alloy castings with an ausferrite microstructure)		< 180 HB	≤ 400	1.29
				180 – 220 HB	> 400 ≤ 450	0.97	
				220 – 260 HB	> 450 ≤ 500	0.75	
N	N1	Commercially pure wrought aluminium		< 60 HB	≤ 240	1.33	
				60 – 100 HB	> 240 ≤ 400	1.00	
				100 – 150 HB	> 400 ≤ 590	0.67	
	N2	Wrought aluminium alloys		< 75 HB	≤ 240	0.67	
				75 – 90 HB	> 240 ≤ 270	0.60	
				90 – 140 HB	> 270 ≤ 440	0.43	
	N3	N2.1	Cast aluminium alloys		< 75 HB	≤ 240	0.67
					75 – 90 HB	> 240 ≤ 270	0.60
					90 – 140 HB	> 270 ≤ 440	0.43
	N3	N3.1	Free-cutting copper-alloys materials with excellent machining properties		–	–	0.70
		N3.2	Short-chip copper-alloys with good to moderate machining properties		–	–	0.41
		N3.3	Electrolytic copper and long-chip copper-alloys with moderate to poor machining properties		–	–	0.21
	N4	N4.1	Thermoplastic polymers		–	–	0.70
					–	–	0.27
					–	–	0.29
N5	N4.2	Thermosetting polymers		–	–	1.00	
				–	–	1.00	
				–	–	1.00	
S	S1	N4.3	Reinforced polymers or composites		–	–	1.00
					–	–	1.00
					–	–	1.00
	S2	N5.1	Graphite		–	–	1.00
					–	–	1.00
					–	–	1.00
	S3	S1.1	Titanium or titanium alloys		< 200 HB	≤ 660	1.94
		S1.2		200 – 280 HB	> 660 ≤ 950	1.72	
S4	S2.1	Fe-based high-temperature alloys		280 – 360 HB	> 950 ≤ 1200	1.44	
	S2.2		< 200 HB	≤ 690	1.33		
S3	S3.1	Ni-based high-temperature alloys		200 – 280 HB	> 690 ≤ 970	1.17	
	S3.2		< 280 HB	≤ 940	1.00		
S4	S4.1	Co-based high-temperature alloys		280 – 360 HB	> 940 ≤ 1200	0.83	
	S4.2		< 240 HB	≤ 800	0.78		
H	H1	Chilled cast iron		240 – 320 HB	> 800 ≤ 1070	0.67	
				< 440 HB	–	1.52	
	H2	Hardened cast iron		< 55 HRC	–	0.90	
				> 55 HRC	–	0.77	
	H3	Hardened steel < 55 HRC		< 51 HRC	–	1.00	
				51 – 55 HRC	–	0.82	
	H4	Hardened steel > 55 HRC		55 – 59 HRC	–	0.64	
				> 59 HRC	–	0.54	



A large, empty rectangular box with a thin black border, occupying most of the page, intended for taking notes.



SIMPLY RELIABLE

As a professional you can judge the quality of work by just looking at the chip. Our chip is a clean and uncomplicated shape that in itself tells a story. It is a clear and consistent signal and that's why we use it as a symbol for being **Simply Reliable**.



881133

DORMER PRAMET

www.dormerpramet.com



**CONTACTS TO LOCAL
SALES SUPPORT
ALWAYS UP TO DATE!**



DP-BRO-NEWS-2023.1-EN

FOLLOW US...



ONLINE



SEGMENTS



LIBRARY APP.



CALCULATOR APP.

